

T161Z SUPER

Digital Proportional R/C System



S.BUS 2













































WEB FULL MANUAL

Futaba®



























Digital Proportional R/C System























1M23Z09102

TABLE OF CONTENTS

 Introduction 6	 Stick Control 24
 Support and Service 6	 Stick Control: Airplane Example 25
 Application, Export, and Modification 6	 Stick Control: Helicopter Example 26
 Compliance Information Statement 7	 Stick Control: Multicopter Example 27
 Definitions of Symbols 7	 Stick Adjustment 28
 Safety Precautions (do not operate without reading) 8	 Stick Mode 29
 Features 12	 microSD card 30
 Contents and Technical Specifications 12	 Connector/Plug 31
 Transmitter Controls 13	 Receiver Nomenclature . . . 32
 Transmitter's Antenna 15	 Receiver's Antenna Installation 37
 Transmitter Lipo Battery LT2F2000B 16	 Safety precautions when you install receiver/servos 38
 How to turn transmitter power ON/OFF 18	 S.BUS/S.BUS2 Installation . . . 39
 Touch Display 19	 S.BUS2 System 40
 HOME/EXIT and U.MENU/MON 19	 S.BUS2 Sdevice setting 41
 Lock Display 20	 Home Screen 42
 RF off mode 20	 Link Procedure 43
 Switch (SA-SH) 21	 After Setting 44
 Volume 22	 Model ID 45
 Slider 22	 Range Testing Your R/C System 46
 Digital Trims (T1-T4) 23	 Model basic setting procedure 47
 Monitor LED display 24	 Servo Connection by Model Type 52
	 Airplane/Glider 52

 [Click to go to the corresponding page](#)

 Helicopter	56
 Multicopter	56
 SYSTEM MENU	57
 Display	58
 Sound volume	59
 System timer	59
 H/W setting	60
 Battery	61
 Range check	61(→ 46)
 S.Bus servo	62
 Servo update	65
 Sensor update	66
 Information	67
 LINKAGE MENU	68
 Servo monitor	69
 Model select	70
 Model type	73
 Servo reverse	75
 End point	76
 Servo speed	77
 Sub-trim	77
 Function	78
 Fail safe	80
 System type	81
 Trim setting	83
 Throttle cut	84

 Idle down	85
 Swash ring (Heli only)	86
 Swash (Heli only, except H-1)	87
 Stick alarm	89
 Timer	90
 Function name	92
 Telemetry system	93
 Sensor	95
 Telemetry	99
 Telemetry:Receiver [Battery]	100
 Telemetry:Receiver [Ext-batt]	101
 Telemetry:Temperature	102
 Telemetry:RPM sensor	103
 Telemetry:Altitude	104
 Telemetry:Altitude [Variometer]	105
 Telemetry:Voltage [Battery]	108
 Telemetry:Voltage [Ext-batt]	109
 Telemetry:GPS [Distance]	110
 Telemetry:GPS [Speed]	112
 Telemetry:GPS [Altitude, Variometer, Position]	113
 Telemetry:Servo sensor [Current]	114
 Telemetry:Servo sensor [Temperature, Angle]	115
 Telemetry:Current sensor [Current]	116

[!\[\]\(125d701e9425b54c764340b5671b38cd_img.jpg\) Click to go to the corresponding page](#)

















Click Telemetry:Airspeed sensor [Airspeed]	117
Click Telemetry:Futaba ESC MC-980H/A, MC-9130H/A, MC9200H/A .	118
Click Telemetry:SBS-01ML for Pixhawk®	120
Click Tele. setting (Telemetry setting)	122
Click Trainer	124
Click Warning setting	127
Click User menu setting	128
Click Data reset	129

Click MODEL MENU (Airplane/Glider)	130
Click Condition select	131
Click AFR	133
Click Dual rate	134
Click Program mixes	135
Click Aileron differential	137
Click Flap setting	138
Click AIL → Camber flap	139
Click AIL → Brake flap	140
Click Aileron → Rudder	141
Click Elevator → Camber	142
Click Camber mixing	143
Click Airbrake → ELE	145
Click Camber flap → ELE	146

Click Rudder → Aileron	147
Click Rudder → Elevator	148
Click Butterfly	149
Click Trim mix 1/2	152
Click Snap roll (Airplane only)	153
Click Air brake (Airplane only)	154
Click Gyro	155
Click Ailevator	157
Click Acceleration	158
Click Motor	159
Click V-tail	160
Click Winglet	161
Click Gyro setting GYA553	162
Click Connection T16IZ SUPER and GYA553	162
Click Home screen	164
Click Config	165
Click S.BUS Basic menu	170

Click MODEL MENU (Helicopter) .	171
Click Condition select	172
Click AFR	174
Click Dual rate	175
Click Program mixes	176
Click Pitch curve	178
Click Throttle curve	181
Click Acceleration	183

 Throttle hold	184
 Swash mixing	185
 Throttle mixing	186
 Pitch → Needle	187
 Pitch → Rudder (Revolution mixing)	188
 Gyro (Helicopter)	189
 Governor	191
 Gyro setting CGY755 CGY760R	193
 Wired connection:Advanced setting	194
 Wireless tunings	195
 Home Screen	196
 Basic Menu	198
 S.BUS Basic Menu	199
 Swash Basic	200
 Flight Tune (Aileron/Elevator Basic settings)	204
 Rudder Basic	207
 Governor Basic	208
 Expert Menu	211
 Rudder Expert	212
 Flight Tune Expert (Aileron/Elevator Expert settings)	215
 Swash Detail	216
 Governor Expert	219

 MODEL MENU (Multicopter)	221
 Condition select	222
 AFR	224
 Dual rate	225
 Program mixes	226
 Gyro	228
 Common Operations used in function setup screen	229
 Operations value setting	229
 Operations related to flight conditions	229
 Operations related to fine tuning VR	230
 Operations related to servo speed	231
 Curve setting operation	232
 Switch selection method	236
 PC Port	240
 RealFlight Connection method	240
 Updating	242
 T14SG/FX-22/T12K ⇒ T16IZ SUPER CONVERSION	244

INTRODUCTION

Thank you for purchasing a Futaba® FASSTest-2.4 GHz* T16IZ SUPER series digital proportional R/C system. This system is extremely versatile and may be used by beginners and pros alike. In order for you to make the best use of your system and to fly safely, please read this manual carefully. If you have any difficulties while using your system, please consult the manual, our online Frequently Asked Questions (on the web pages referenced below), your hobby dealer, or the Futaba Service Center.

*FASSTest: Futaba Advanced Spread Spectrum Technology extend system telemetry

Due to unforeseen changes in production procedures, the information contained in this manual is subject to change without notice.

Support and Service: It is recommended to have your Futaba equipment serviced annually during your hobby's "off season" to ensure safe operation.

In North America

Please feel free to contact the Futaba Service Center for assistance in operation, use and programming. Please be sure to regularly visit the T16IZ SUPER Frequently Asked Questions web site at www.futabausa.com/. This page includes extensive programming, use, set up and safety information on the T16IZ SUPER radio system and is updated regularly. Any technical updates and US manual corrections will be available on this web page. If you do not find the answers to your questions there, please see the end of our F.A.Q. area for information on contacting us via email for the most rapid and convenient response.

Don't have Internet access? Internet access is available at no charge at most public libraries, schools, and other public resources. We find internet support to be a fabulous reference for many modelers as items can be printed and saved for future reference, and can be accessed at any hour of the day, night, weekend or holiday. If you do not wish to access the internet for information, however, don't worry. Our support teams are available Monday through Friday 8-5 Central time to assist you.

For Service :

FUTABA Corporation of America
2681 Wall Triana Hwy Huntsville, AL 35824, U.S.A.
Phone:1-256-461-9399 FAX:1-256-461-1059
<https://www.futabausa.com/>
E-mail: service@futabaUSA.com

Please visit www.futabausa.com to create and submit a service ticket for warranty, repair, or check up work

Outside North America

Please contact your Futaba importer in your region of the world to assist you with any questions, problems or service needs. Please recognize that all information in this manual, and all support availability, is based upon the systems sold in North America only. Products purchased elsewhere may vary. Always contact your region's support center for assistance.

Application, Export, and Modification

1. This product may be used for unmanned aerial vehicle use. It is not intended for use in any application other than unmanned aerial vehicle control. The product is subject to regulations of the Ministry of Radio/Telecommunications and is restricted under Japanese law to such purposes.

2. Exportation precautions:

(a) When this product is exported from the country of manufacture, its use is to be approved by the laws governing the country of destination which govern devices that emit radio frequencies. If this product is then re-exported to other countries, it may be subject to restrictions on such export. Prior approval of the appropriate government authorities may be required. If you have purchased this product from an exporter outside your country, and not the authorized Futaba distributor in your country, please contact the seller immediately to determine if such export regulations have been met.

(b) Use of this product with anything other than models may be restricted by Export and Trade Control Regulations, and an application for export approval must be submitted. This equipment must not be utilized to operate equipment other than radio controlled models.

3. Modification, adjustment, and replacement of parts: Futaba is not responsible for unauthorized modification, adjustment, and replacement of parts on this product. Any such changes may void the warranty.

Compliance Information Statement (for U.S.A.)

This device complies with part 15 of the FCC Rules. Operation is subject to the following two conditions:

(1) This device may not cause harmful interference, and (2) This device must accept any interference received, including interference that may cause undesired operation.

(3) RF Radiation Exposure Statement (For T16IZ SUPER)

This equipment complies with FCC radiation exposure limits set forth for an uncontrolled environment. This transmitter must not be co-located or operating in conjunction with any other antenna or transmitter.

RF Radiation Exposure Statement (For R7208S/R7308SB)

This equipment complies with FCC radiation exposure limits set forth for an uncontrolled environment. This equipment should be installed and operated with minimum distance 20cm between the radiator & your body.

The responsible party for the compliance of this device is:

FUTABA Corporation of America

2681 Wall Triana Hwy Huntsville, AL 35824, U.S.A.

Phone: 1-256-461-9399 FAX: 1-256-461-1059

<https://www.futabausa.com/>

E-mail: service@futabaUSA.com

CAUTION:

To assure continued FCC compliance:

Any changes or modifications not expressly approved by the grantee of this device could void the user's authority to operate the equipment.

Compliance Information Statement (for Canada)

This device complies with Industry Canada license-exempt RSS standard(s). Operation is subject to the following two conditions: (1) this device may not cause interference, and (2) this device must accept any interference, including interference that may cause undesired operation of the device.

This equipment complies with IC radiation exposure limits set forth for an uncontrolled environment. This transmitter must not be co-located or operating in conjunction with any other antenna or transmitter.

French:

Cet appareil radio est conforme au CNR d'Industrie Canada. L'utilisation de ce dispositif est autorisée seulement aux deux conditions suivantes : (1) il ne doit pas produire de brouillage, et (2) l'utilisateur du dispositif doit être prêt à accepter tout brouillage radioélectrique reçu, même si ce brouillage est susceptible de compromettre le fonctionnement du dispositif.

Cet équipement est conforme aux limites d'exposition au rayonnement du CI établies pour un environnement non contrôlé. Cet émetteur ne doit pas être co-situé ou fonctionner conjointement avec une autre antenne ou émetteur.

Declaration of Conformity (for EU)

Hereby, Futaba Corporation declares that the radio equipment type is in compliance with Directive 2014/53/EU.

The full text of the EU declaration of conformity is available at the following internet address:

<https://www.rc.futaba.co.jp/english/dl/declarations.html>

<https://www.rc.futaba.co.jp/support/manual/>

Flying Safety

Where to Fly

We recommend that you fly at a recognized model airplane flying field. You can find model clubs and fields by asking your nearest hobby dealer, or, in the US, by contacting the Academy of Model Aeronautics.

The national Academy of Model Aeronautics (AMA) has more than 2,500 chartered clubs across the country. Through any one of them, instructor training programs and insured newcomer training are available. Contact the AMA at the address or toll-free phone number below.

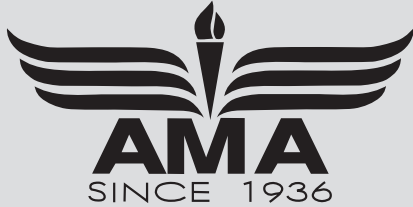

Academy of Model Aeronautics

5161 East Memorial Drive

Muncie, IN 47302

Tele. (800) 435-9262

Fax (765) 289-4248

or via the Internet at <http://www.modelaircraft.org>

Always pay particular attention to the flying field's rules, as well as the presence and location of spectators, the wind direction, and any obstacles on the field. Be very careful flying in areas near power lines, tall buildings, or communication facilities as there may be radio interference in their vicinity.

Precautions

Application, Export, and Modification Precautions.

1. This product is only designed for use with radio control models. Use of the product described in this instruction manual is limited to radio control models.
2. Export precautions:
 - a) When this product is exported, it cannot be used where prohibited by the laws governing radio waves of the destination country.
 - b) Use of this product with other than models may be restricted by Export and Trade Control Regulations.
3. Modification, adjustment, and parts replacement:

Futaba is not responsible for unauthorized modification, adjustment, or replacement of parts on this product.

 - No part of this manual may be reproduced in any form without prior permission.
 - The contents of this manual are subject to change without prior notice.
 - The contents of this manual should be complete, but if there are any unclear or missing parts please contact a Futaba Service Center.
 - Futaba is not responsible for the use of this product by the customer.
 - Company and product names in this manual are trademarks or registered trademarks of the respective company.

For safe use

Please observe the following precautions to ensure safe use of this product at all times.

Meaning of Special Markings:

The parts of this manual indicated by the following marks require special attention from the standpoint of safety.

- ⚠ **DANGER** - Procedures which may lead to dangerous conditions and cause death/serious injury if not carried out properly.
- ⚠ **WARNING** - Procedures which may lead to a dangerous condition or cause death or serious injury to the user if not carried out properly, or procedures where the probability of superficial injury or physical damage is high.
- ⚠ **CAUTION** - Procedures where the possibility of serious injury to the user is small, but there is a danger of injury, or physical damage, if not carried out properly.

⊘ = Prohibited ⚠ = Mandatory

WARNING: Always keep electrical components away from small children.

Flying Precautions

⚠ WARNING

⊘ Never grasp the transmitter antenna while flying.

- The transmitter output may drop drastically.

⚠ Always make sure that all transmitter stick movements operate all servos properly in the model prior to flight. Also, make sure that all switches, etc. function properly as well. If there are any difficulties, do not use the system until all inputs are functioning properly.

⊘ Never fly in range check mode.

- In the dedicated range test range check mode, the transmitter output range is reduced and may cause a crash.

⊘ While operating, never touch the transmitter with, or bring the transmitter near, another transmitter, a cell-phone, or other wireless devices.

- Doing so may cause erroneous operation.

⊘ Do not point the antenna directly toward the aircraft during flight.

- The antenna is directional and the transmitter output is weakest. (The strength of the radio waves is greatest from the sides of the antenna.)

⊘ Never fly on a rainy day, when the wind is strong, or at night.

- Water could lead to failure or improper functionality and poor control of the aircraft which could lead to a crash.

⊘ Never turn the power switch off during flight or while the engine or motor is running.

- Operation will become impossible and the aircraft will crash. Even if the power switch is turned on, operation will not begin until transmitter and receiver internal processing is complete.

⊘ Do not start the engine or motor while wearing the neck strap.

- The neck strap may become entangled with the rotating propeller, rotor, etc. and cause a serious injury.

⊘ Do not fly when you are physically impaired as it could pose a safety hazard to yourself or others.

⊘ Do not fly at the following places:

- Near another radio control flying field.
- Near or above people.
- Near homes, schools, hospitals or other places where people congregate.
- Near high voltage lines, high structures, or communication facilities.

⊘ When setting the transmitter on the ground during flight preparations, do not stand it upright.

- The transmitter may tip over, the sticks may move and the propeller or rotor may rotate unexpectedly and cause injury.

⊘ Do not touch the engine, motor, or ESC during and immediately after use.

- These items may become hot during use.

⚠ For safety, fly so that the aircraft is visible at all times.

- Flying behind buildings or other large structures will not only cause you to lose sight of the aircraft, but also degrade the RF link performance and cause loss of control.

⚠ From the standpoint of safety, always set the fail safe function.

- In particular, normally set the throttle channel to idle. For a helicopter, set the throttle channel to maintain a hover.

⚠ When flying, always return the transmitter setup screen to the Home screen.

- Erroneous input during flight is extremely dangerous.

⚠ Always check the remaining capacity of the transmitter and receiver batteries before each flying session prior to flight.

- Low battery capacity will cause loss of control and a crash.

⚠ Always check operation of each control surface and perform a range test before each flying session. Also, when using the trainer function, check the operation of both the teacher and student transmitter.

- Even one incorrect transmitter setting or aircraft abnormality can cause a crash.

⚠ Before turning on the transmitter:

1. Always move the transmitter throttle stick position to the minimum (idle) position.

2. Turn on the transmitter first and then the receiver.

⚠ When turning off the transmitter's power switch after the engine or motor has stopped (state in which it will not rotate again):

1. Turn off the receiver power switch.

2. Then turn off the transmitter power switch.

- If the power switch is turned on/off in the opposite order, the propeller may rotate unexpectedly and cause a serious injury.

- Also always observe the above order when setting the fail safe function.

⚠ When adjusting the transmitter, stop the engine except when necessary. In the case of a motor, disconnect the wiring that allows it to continue operation. When doing so, please exercise extreme caution. Ensure that the aircraft is secured and that it will not come into contact with anything or anyone. Ensure that the motor will not rotate prior to making any adjustments.

- Unexpected high speed rotation of the engine/motor may cause a serious injury.

Battery and Charger Handling Precautions

⚠ DANGER

- ⊘ Do not recharge a battery that is damaged, deteriorated, leaking electrolyte, or wet.
- ⊘ Do not allow the charger or battery to become wet.
 - Do not use the charger when it or your hands are wet. Do not use the charger in humid places.
- ⊘ Do not short circuit the battery.
- ⊘ Do not solder, repair, deform, modify, or disassemble the battery and/or battery charger.
- ⊘ Do not drop the battery into a fire or bring it near a fire.
- ⊘ Do not charge and store the battery in direct sunlight or other hot places.
- ⊘ Do not charge the battery if it is covered with any object as it may become very hot.
- ⊘ Do not use the battery in a combustible environment.
 - The combustibles may could ignite ignite and cause an explosion or fire.
- ⚠ Always charge the battery before each flying session.
 - If the battery goes dead during flight, the aircraft will crash.
- ⚠ Insert the power cord plug firmly into the receptacle up to its base.

⚠ WARNING

- ⊘ Do not touch the charger and battery for any length of time during charging.
 - Doing so may result in burns.
- ⊘ Do not use a charger or battery that has been damaged.
- ⊘ If any abnormalities such as smoke or discoloration are noted with either the charger or the battery, remove the battery from the transmitter or charger and disconnect the power cord plug and do not use the charger.
 - Continued use may cause fire, combustion, generation of heat, or rupture.
- ⊘ Do not subject the batteries to impact.
 - Doing so may cause fire, combustion, generation of heat, rupture, or liquid leakage.
- ⚠ Use and store the battery and battery charger in a secure location away from children.
 - Not doing so may cause electric shock or injury.

⚠ CAUTION

- ⊘ Do not fly with the USB AC adapter for charging connected.
- ⊘ Do not use the battery with devices other than the corresponding transmitter.
- ⊘ Do not place heavy objects on top of the battery or charger. Also, do not place the battery or charger in any location where it may fall.
 - Doing so may cause damage or injury.
- ⊘ Do not store or use the battery where it is dusty or humid.

- ⚠ Always use the charger with the specified power supply voltage.
- ⚠ If the battery liquid should get in your eyes, do not rub your eyes, but immediately wash them with tap water or other clean water and get treated by a doctor.
 - The liquid can cause blindness.

⚠ Temperature protection for battery charge:

	Temperature
Low temp. protection	-10 ± 5° C
High temp. protection	60 ± 5° C

1. Replacement of a battery with an incorrect type that can defeat a safeguard.
2. Disposal of a battery into fire or a hot oven, or mechanically crushing or cutting of a battery, that can result in an explosion.
3. Leaving a battery in an extremely high temperature surrounding environment that can result in an explosion or the leakage of flammable liquid or gas.
4. A battery subjected to extremely low air pressure that may result in an explosion or the leakage of flammable liquid or gas.

- ⚠ If the battery leaks liquid or generates an abnormal odor, immediately move it to a safe place for disposal.
 - Not doing so may cause combustion.
- ⚠ If the battery liquid gets on your skin or clothing, immediately flush the area with tap water or other clean water.
 - Consult a doctor. The liquid can cause skin damage.
- ⚠ After charging, disconnect the charger from the receptacle.
- ⚠ When recycling or disposing of the battery, isolate the terminals by covering them with tape.
 - Short circuit of the terminals may cause combustion, generation of heat or rupture.

- Insert the power cord plug into the receptacle only after eliminating the dust.
- ⊘ After the transmitter has been used for a long time, the battery may become hot. Do not touch the battery immediately.
 - Not doing so may cause a burn.
- ⊘ Do not bend or pull the cord unreasonably and do not place heavy objects on the cord.
 - The power cord may be damaged and cause combustion, generation of heat, or electric shock.

micro SD Card (Commercial Product) Handling Precautions

*Read the instruction manual supplied with the microSD card for details.

⚠ WARNING

- ⊘ Never disassemble or modify the microSD card.
- ⊘ Do not bend, drop, scratch or place heavy objects on the microSD card.
- ⊘ If smoke or an abnormal odor emanates from the card, immediately turn off the transmitter power.

⚠ CAUTION

- ⚠ Since the microSD card is an electronic device, be careful of static electricity.
 - Static electricity may cause erroneous operation or other trouble.
- ⊘ Do not use the microSD card near radio and television sets, audio equipment, motors and other equipment that generates noise.
 - Doing so may cause erroneous operation.
- ⊘ Do not store the microSD card in the following places:
 - Where the humidity is high
 - Where the temperature difference is severe
 - Where it is very dusty
 - Where the card will be exposed to shock and vibration
 - Near speakers and other magnetic devices

- ⊘ Do not use the microSD card where it may be exposed to water, chemicals, oil, or other fluids.

■ Doing so may cause a fire or electric shock by short circuiting.

- ⊘ Do not insert foreign matter into the transmitter card slot.

■ Doing so may cause erroneous operation.

- ⊘ Do not expose the card to shock and vibration and do not remove the card from the card slot while data is being written or read.

■ The data may be damaged or lost.

● Recorded data

The data recorded on the microSD card cannot be compensated regardless of the contents or cause of the trouble or obstruction. Futaba does not perform data restoration or recovery work.

Storage and Disposal Precautions

⚠ WARNING

- ⊘ Keep wireless equipment, batteries, aircraft, etc. away from children.

⚠ CAUTION

- ⊘ Do not store wireless devices in the following places:
 - Where it is extremely hot (40°C [104 °F] or higher) or cold (-10°C [14 °F] or lower)
 - Where the equipment will be exposed to direct sunlight
 - Where the humidity is high
 - Where vibration is prevalent
 - Where it is very dusty
 - Where the device may be exposed to steam and heat

- ⚠ When the device will not be used for a long time, remove the batteries from the transmitter and aircraft and store them in a dry place where the temperature is between 0°C and 25°C [32 °F and 77 °F].

■ Leaving batteries inside your model and radio when they are not being used for long periods will result in battery deterioration, liquid leakage and other damage.

Other Precautions

⚠ CAUTION

- ⊘ Do not directly expose plastic parts to fuel, oil, exhaust gas, etc.

■ If left in such an environment, the plastic may be damaged.
■ Since the metal parts of the case may corrode, always keep them clean.

⚠ Join the Academy of Model Aeronautics.

■ The Academy of Model Aeronautics (AMA) provides guidelines and liability protection should the need arise.

- ⚠ Always use genuine Futaba products such as transmitter, receiver, servo, ESC, etc.

■ Futaba is not responsible for damage sustained by combination with parts other than Futaba Genuine Parts. Use the parts specified in the instruction manual and catalog.

Features

FASSTest system

The T16IZ SUPER transmitter has adopted the bidirectional communication system "FASSTest". Data from the receiver can be checked in your transmitter. FASSTest is a maximum 18 channels 2.4 GHz dedicated system.

Color touch screen LCD

T16IZ SUPER has an HVGA 4.3 inch, full-color, backlit LCD touch screen. The screen is transfective which enables both indoor and outdoor visibility.

S.BUS2 system

By using the S.BUS2 system multiple servos, gyros and telemetry sensors are easily installed with a minimum amount of cables.

Model types

Multicopter. 8 swash types are available for helicopters. 7 wing types and 3 tail types are available for airplanes and gliders. Functions and mixing functions necessary for each model type are set in advance at the factory.

Lithium-ion polymer battery

T16IZ SUPER is operated by a 7.4 V/2,000 mAh Lithium-ion polymer battery.

microSD card (Secure Digital memory card) (Not included)

Model data can be saved to a microSD card (SD:32MB-2GB SDHC:4GB-32GB). When T16IZ SUPER transmitter software files are released, the software can be updated by using a microSD card update.

Edit button

Two edit buttons are provided, and the operating screen can be immediately "Returned" to the HOME screen during operation. Setting operation can be performed easily by combining this button with a touch sensor.

Vibration function

Selects a function that alerts the operator to various alarms by vibrating the transmitter in addition to sounding a buzzer.

Speech function

A function is equipped which allows the system to provide telemetry data audibly. This function can also be utilized with commercially available earphones.

Contents and Technical Specifications

- **T16IZ SUPER Transmitter**
- **USB Cable**
- **R7208SB or R7308SB Receiver**
- **Hex Key**
- **LT2F2000B LiPo Battery**
- **Tx Strap**
- **Short Manual**

(Specifications and ratings are subject to change without notice.)

*The contents may vary on the type of set.

(Some products do not include a receiver.)

Transmitter T16IZ SUPER

(2-stick, 18-channel, FASSTest-2.4 GHz system)

Transmitting frequency: 2.4 GHz band
System: FASSTest 18CH/FASSTest 12CH/S-FHSS/T-FHSS/
FASST MULT(Europe is not supported)/FASST 7CH(Europe is not supported) switchable
Power supply: 7.4 V LT2F2000B LiPo battery
Frequency band: 2.4 GHz
RF power output : 100 mW EIRP

Receiver R7208SB /R7308SB

(FASSTest-2.4 GHz system, Dual Antenna Diversity, S.BUS/S.BUS2 system)

Dual antenna diversity (R7308SB Sleeve antenna)
Power requirement: 3.7 V-7.4 V battery or regulated output from ESC, etc. (*1)
Battery F/S Voltage: It sets up with a transmitter
Extra Voltage port: 0-70 V DC
Size: 0.98 x 1.53 x 0.56 in. (24.9 x 38.8 x 14.3 mm)
Weight: R7208SB 0.35 oz. (9.9 g) / R7308SB 0.39 oz. (11.0 g)
Frequency band: 2.4 GHz

(*1) When using ESCs make sure that the regulated output capacity meets your usage application.
Never use dry batteries for the power supply of the R7208SB/R7308SB as they may cause difficulties.

Note: This set does not include a charger. Use a commercially available USB charger AC adapter (USB-A type 5 V-2 A) or the Futaba optional USB AC adapter.

Note: The battery in the T16IZ SUPER transmitter does not arrive already attached to the battery connector. Please connect the battery connector before use.

Transmitter Controls

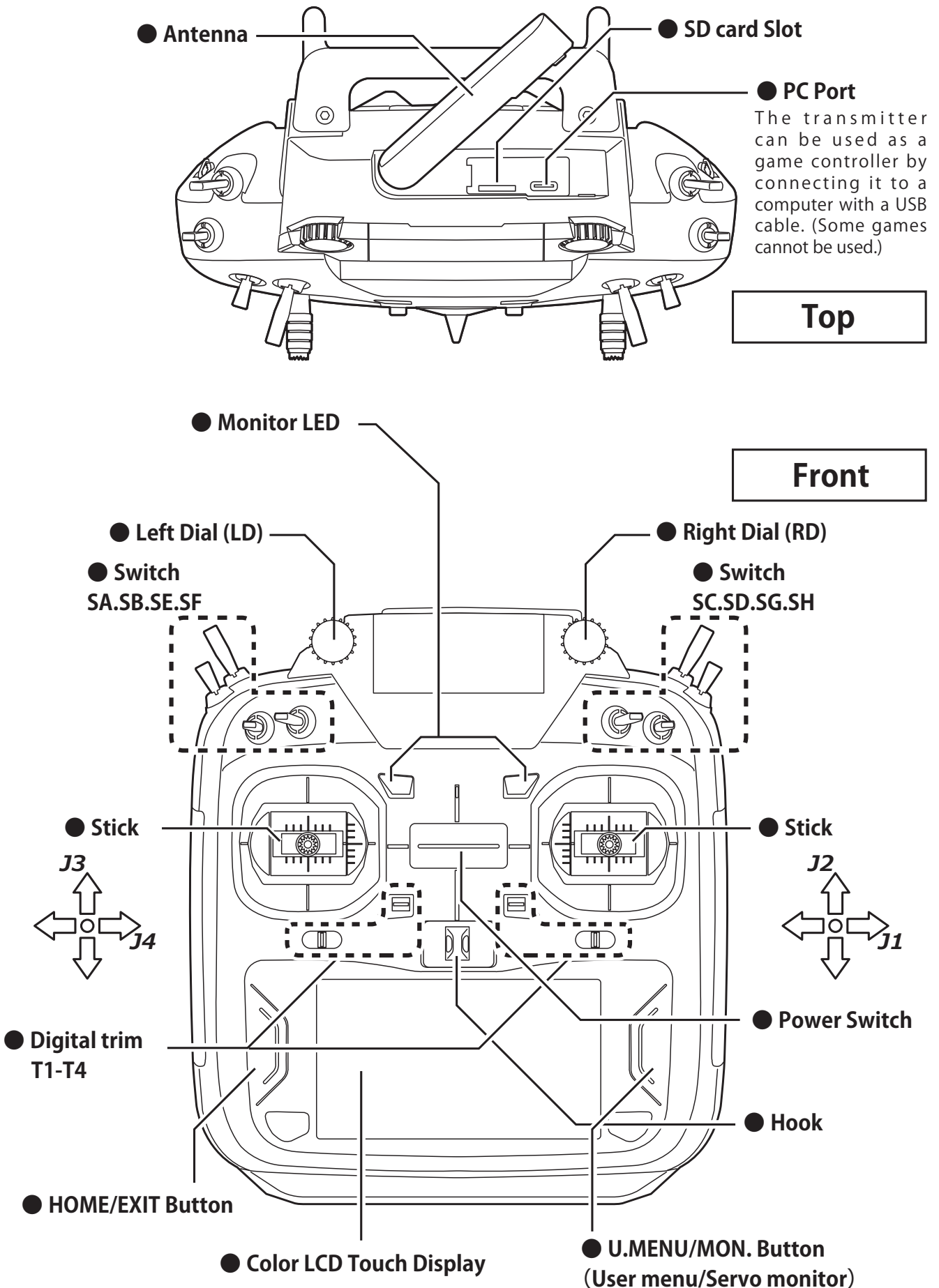

● Stick tension adjustment port

Back

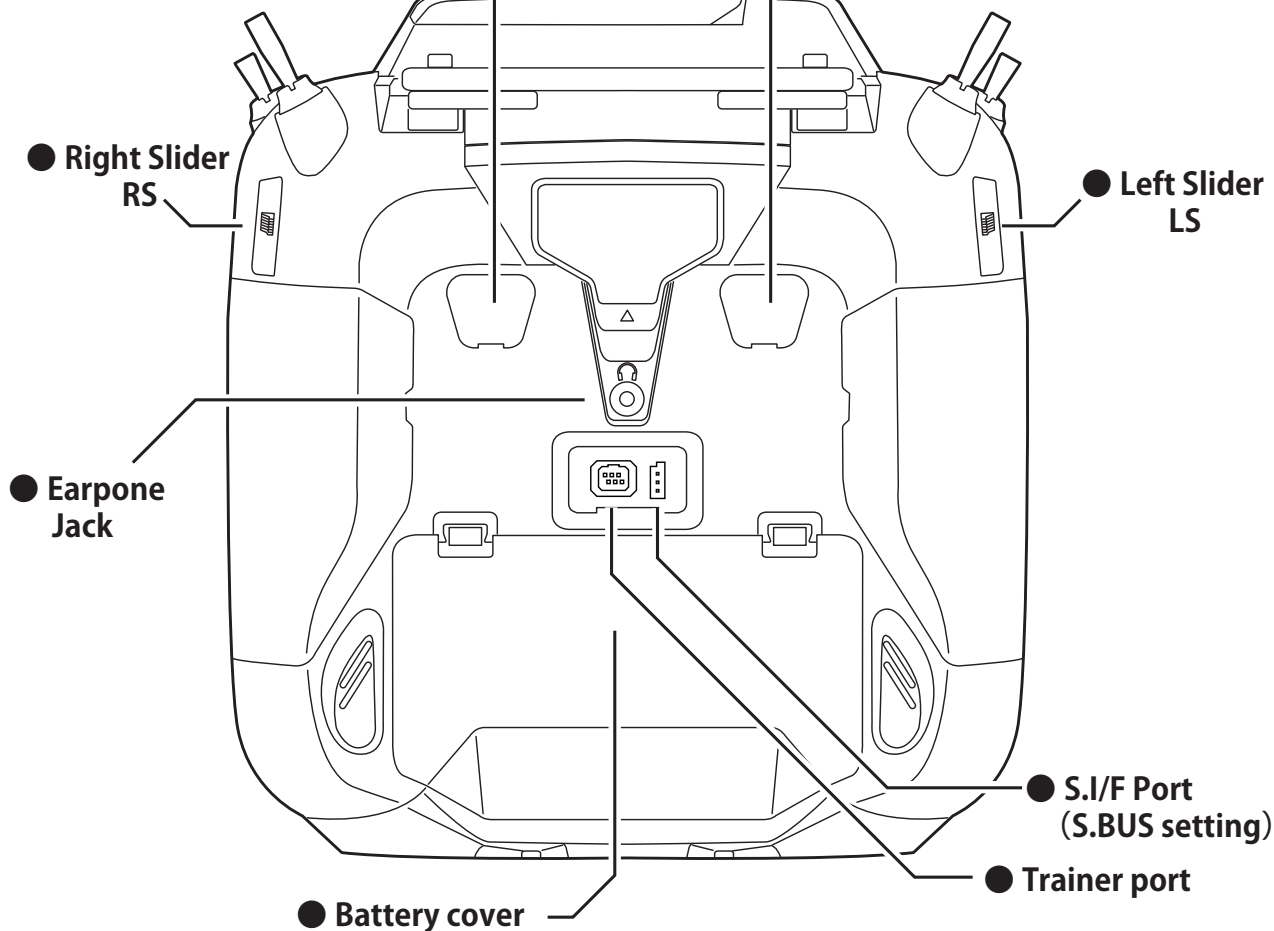

● Charging Port

● Kickstand

The angle when the transmitter is placed can be changed by rotating the swing handle and tightening the screw.

Bottom

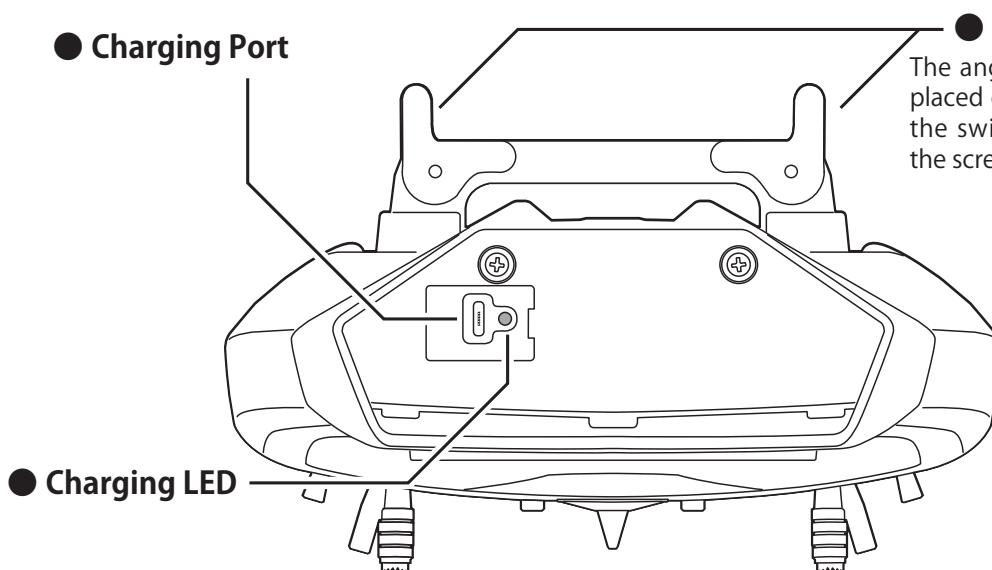

The LCD displays shown in this manual may vary from your own, depending upon your model type. LCD displays may also vary as a result of version upgrades or other changes.

Transmitter's Antenna

As with all radio frequency transmissions, the strongest area of signal transmission is from the sides of the transmitter's antenna. As such, the antenna should not be pointed directly at the model. If your flying style creates this situation, easily move the antenna to correct this situation.

Rotating antenna

The antenna can be rotated 90 degrees and angles 90 degrees. Forcing the antenna further than this can damage it. The antenna is not removable.

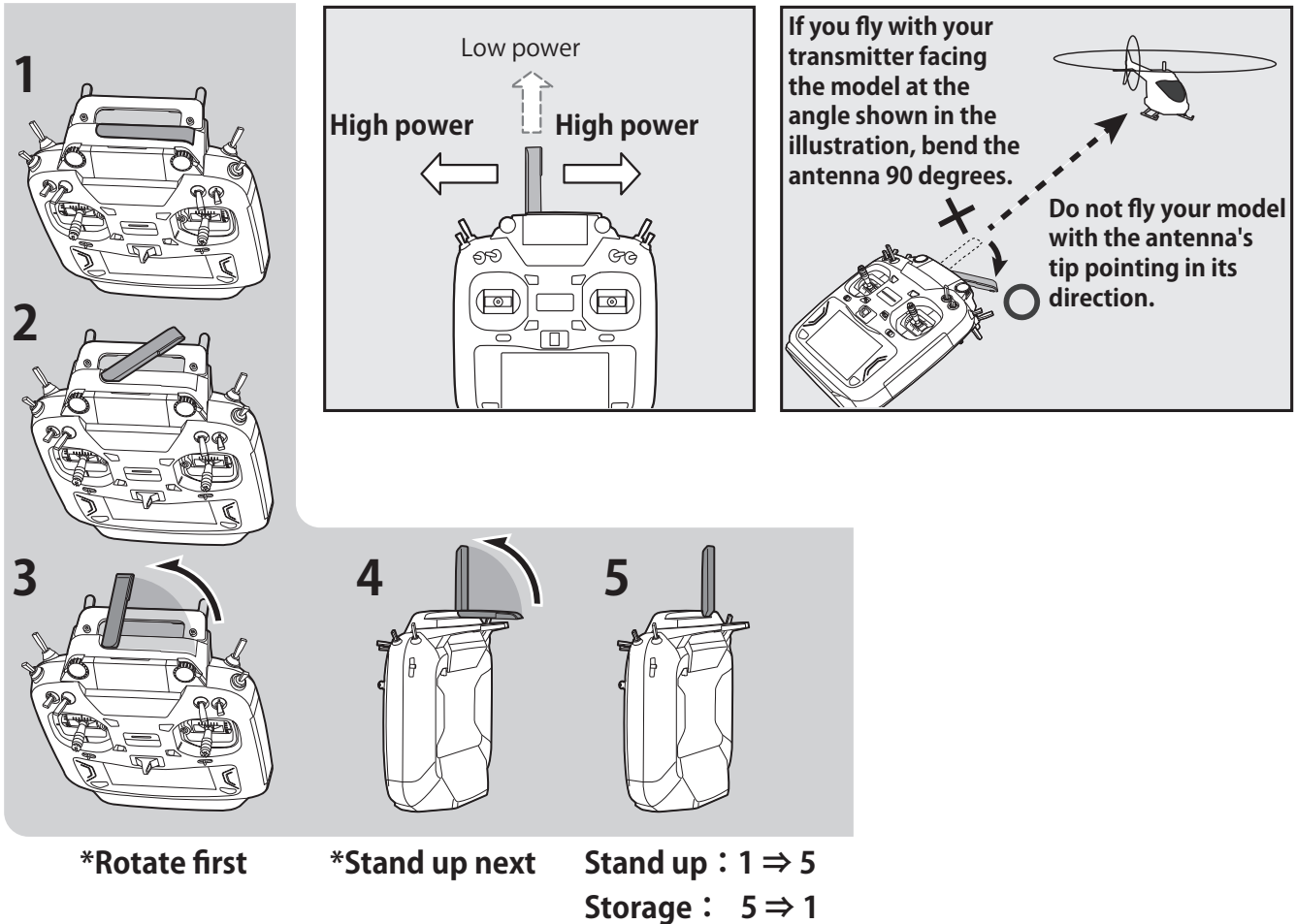

⚠ CAUTION

❗ Do not grasp the transmitter antenna during flight.

- Doing so may degrade the quality of the RF transmission to the model.

⊘ Do not carry the transmitter by the antenna.

- The antenna wire may break, making operation impossible.

⊘ Do not pull the antenna forcefully.

- The antenna wire may break, making operation impossible.

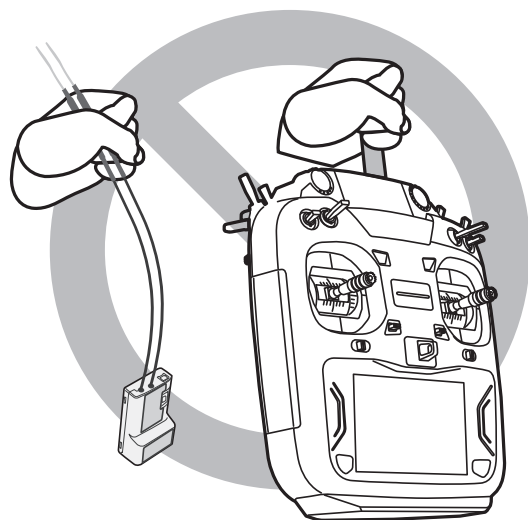

Transmitter LiPo Battery LT2F2000B

Installing/removing the LT2F2000B

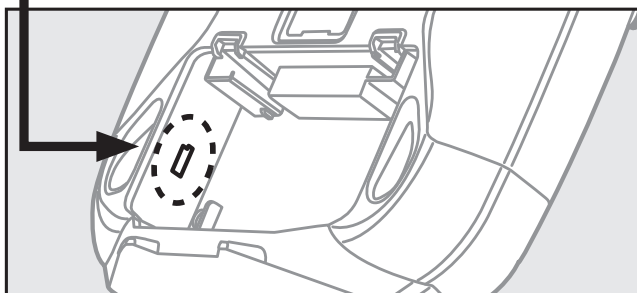
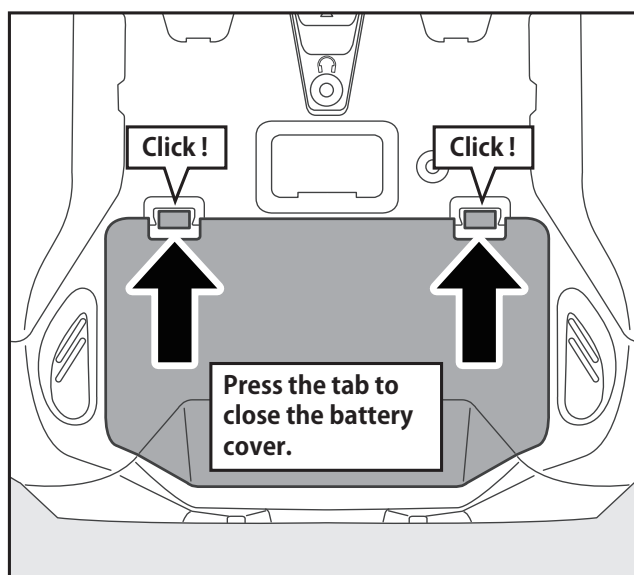
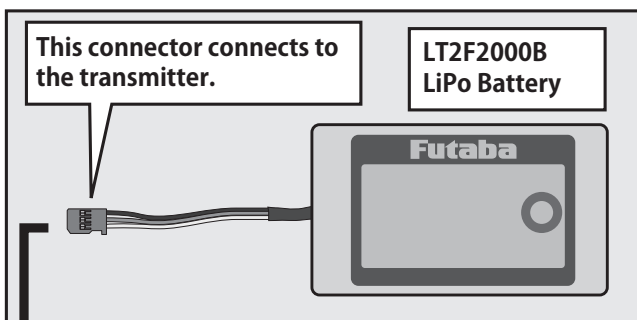
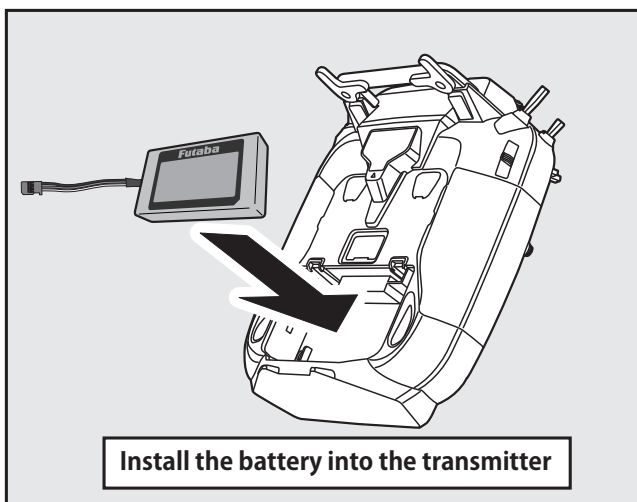
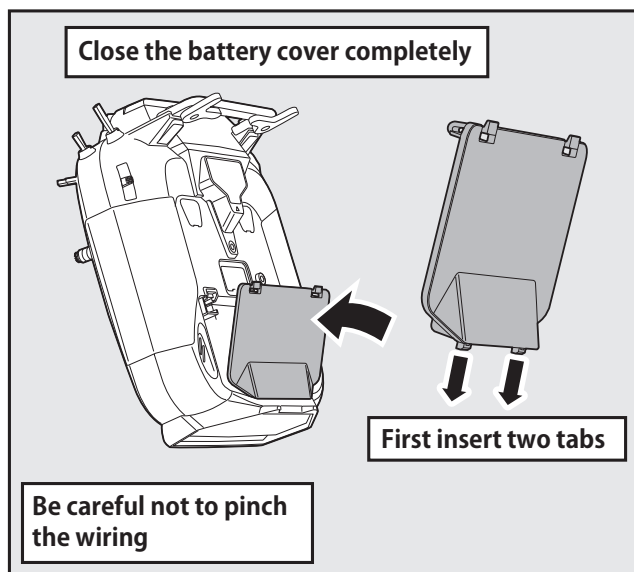
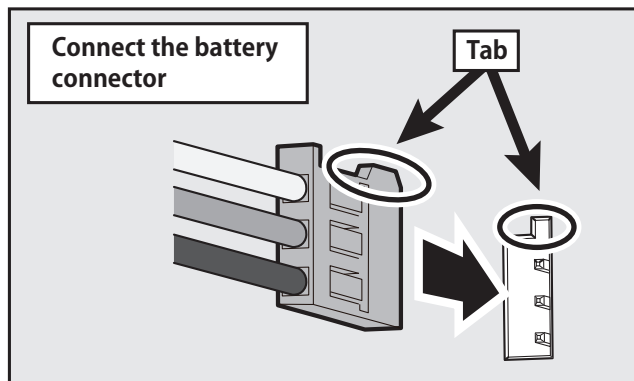
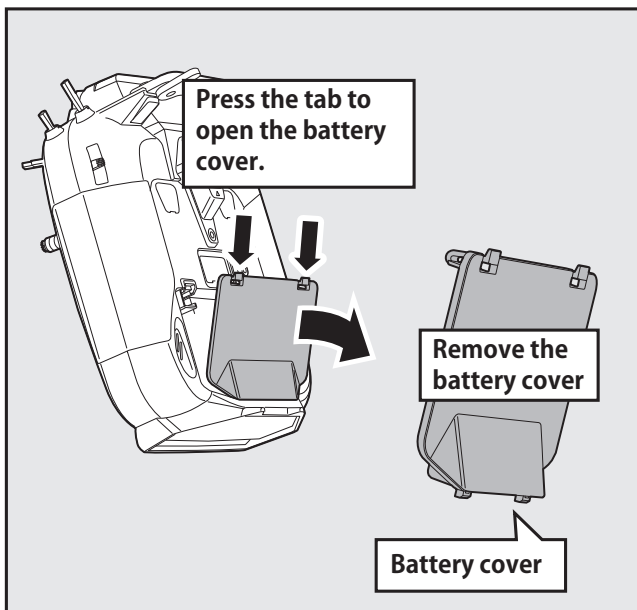

⚠ CAUTION

❗ Be sure to lock the battery cover.

* If the battery cover comes off during flight, the battery will fall off and crash.

Charging a battery

This set is not equipped with an AC adapter for charging. Must be purchased separately.

- AC adapter USB-A type 5 V - 2 A
or
- Futaba option AC adapter USB type

Access the charge port by flipping the rubber cover on the bottom of the transmitter.

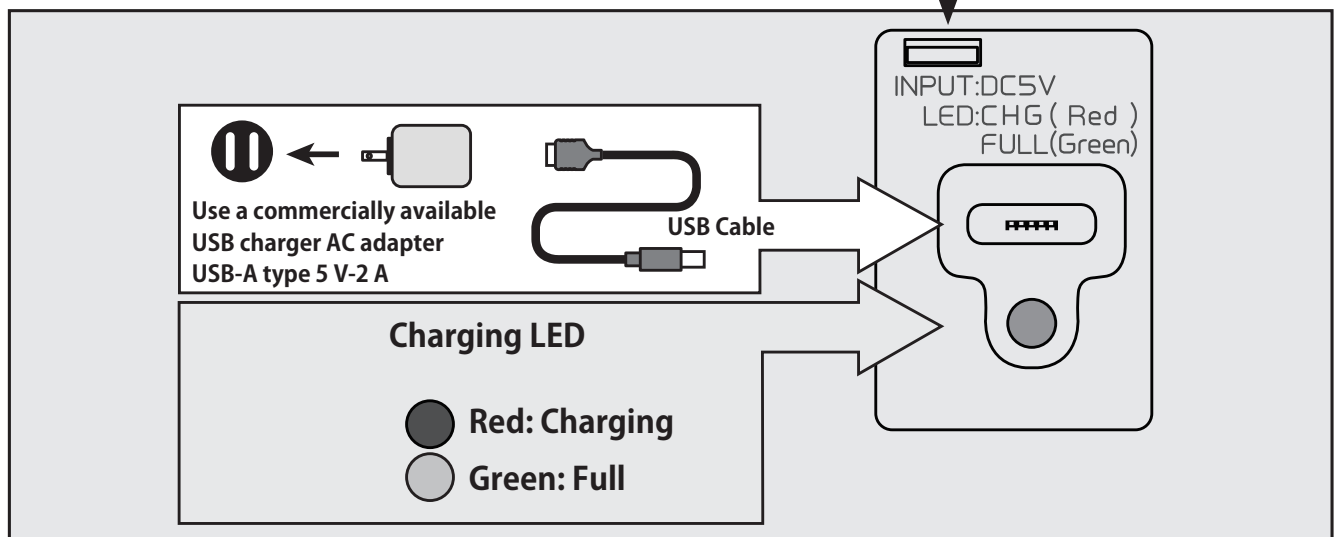
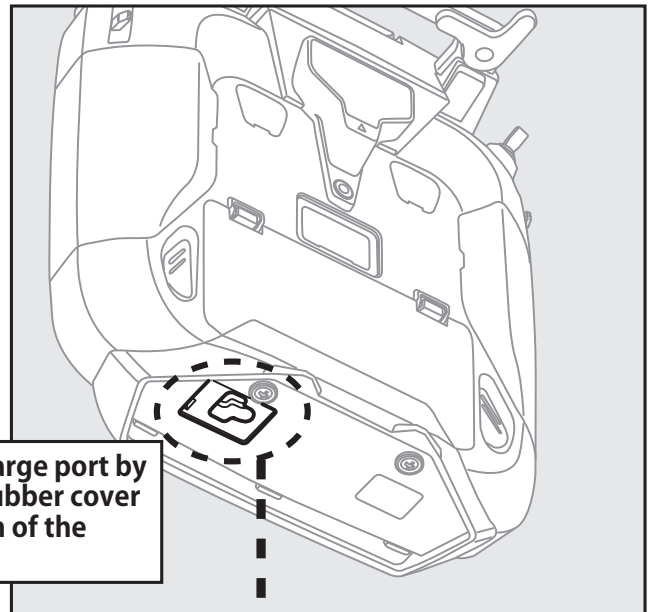

⚠ WARNING

⚠ Be careful not to drop the battery.

⚠ Never disconnect the battery connector from the T16IZ SUPER transmitter after turning off the power until the screen is completely blank and the transmitter has shut down completely.

* Internal devices such as memories may be damaged.

* If there is any problem, the message "Backup Error" will be shown the next time when you turn on the power of the transmitter. Do not use the transmitter as it is. Send it to the Futaba service center.

⚠ WARNING

⚠ Do not plug and unplug the charger when your hands are wet.

*It may cause an electric shock.

⚠ Do not overcharge/overdischarge the battery.

*Overcharging/Overdischarging a battery can result in burns, fire, injuries, or loss of sight due to overheating, breakage, or electrolyte leakage.

⚠ CAUTION

⚠ When the charger is not in use, disconnect it from the AC outlet.

* Do this to prevent accidents and to avoid overheating.

How to turn transmitter power ON/OFF

When turning on the power, the T16IZ SUPER transmitter will begin emitting RF automatically after it confirms the surrounding RF conditions. The status of the transmitter is displayed by LED at the upper part of the front of a T16IZ SUPER.

*If THR stick is high, a WARNING screen will appear. Another warning will appear if a power supply is attached. (In Multicopter mode, the THR position alarm will not appear.)

Power ON

Throttle Stick Low

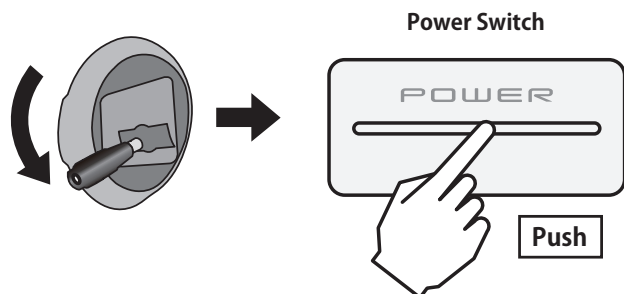

Power OFF

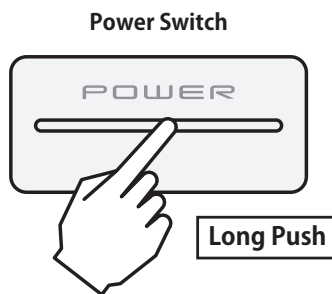

If the "Thr position" alarm displays

*If the throttle stick is in the high position when the power is turned ON

When the alarm activates, lower the throttle stick before turning the receiver power ON.

*If the power is turned ON when the idle-up, air brake, etc., switches are ON, the above warning will display. Ensure the relevant switches are turned OFF.



If the power switches are turned off in the opposite order the model may unexpectedly run out of control and cause a very dangerous situation.

Turning on the power switches

1. Turn on the transmitter power switch.
2. Turn on the receiver or speed control power switch.

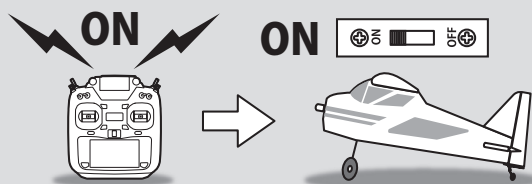

Turning off the power switches

- Always be sure the motor/engine is stopped.
- 1. Turn off the receiver or speed control power switch.
- 2. Then turn off the transmitter power switch.

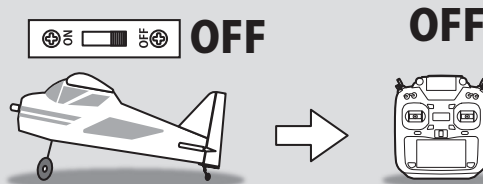

Touch Display

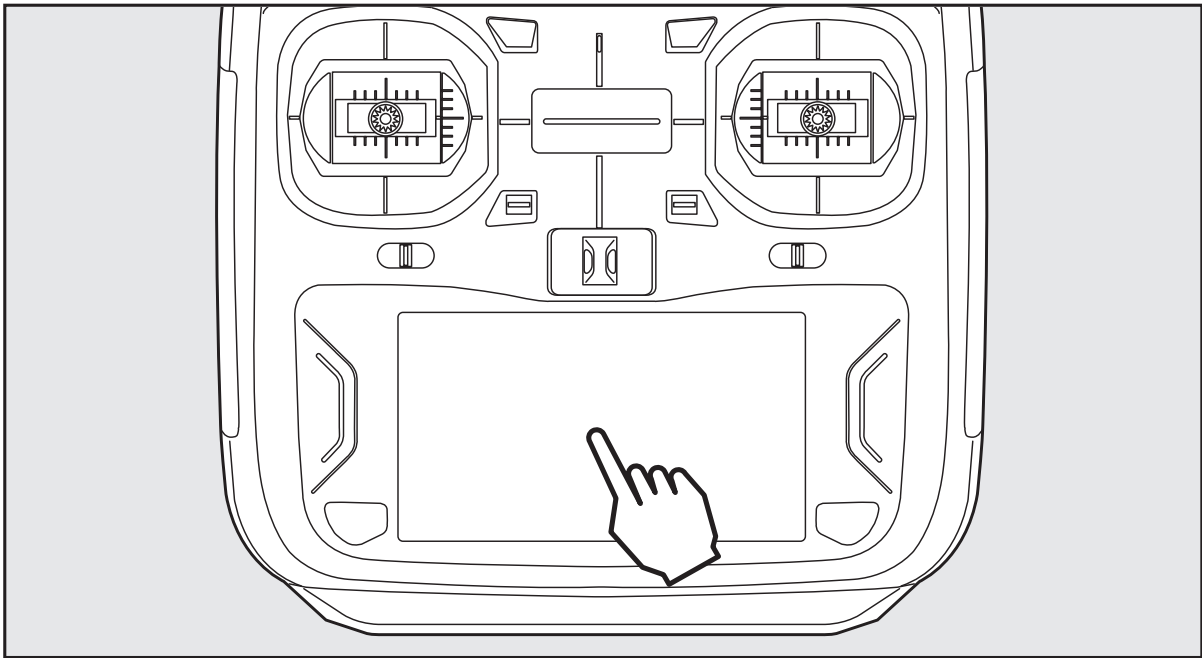

Tap the panel with your finger to navigate.

- *Plastic film is attached to the Touch Display. Please be careful so that you don't scratch the Touch Display with anything hard such as a metal object. Don't push the Touch Display with excessive force or drop anything on the panel.
- *Although you may find some air bubbles under the plastic panel due to environmental changes such as temperature, it is not a defect and will cause no problems.
- *Color LCD is made from many pixels. Some pixels hold lighting. Moreover, some pixels go out. And a screen may flicker. Such condition is the characteristics of color LCD. It is not failure.

EXP B

-100.0

Tapping the settings buttons for each value on the settings screen will cause value input buttons to appear at the top of the panel.

Pressing and holding a value will return it to its default setting.

Value input buttons display at the top of the display.

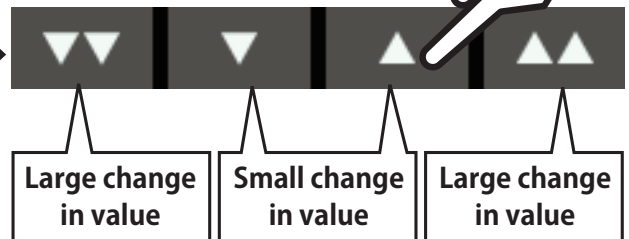

HOME/EXIT and U.MENU/MON.

HOME/EXIT	
Press	Return to the previous screen
Press and hold	Return to the home screen
Press from HOME screen.	To Telemetry display
Press and hold from HOME screen.	Panel lock / Lock release

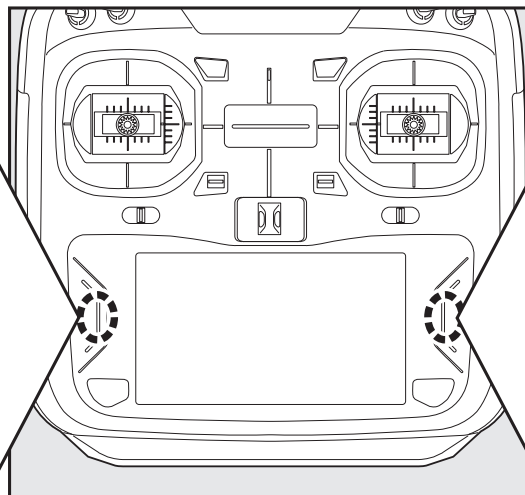

U.MENU/MON.	
Press	To user menu display
Press and hold	To servo monitor display

Lock Display

Temporarily activating this function makes it impossible to change data by accidental input during flight.

How to lock

1. With the home screen displayed.
2. Press the HOME/EXIT button for about 1 second. "Key Icon" is displayed and the keys will be disabled.

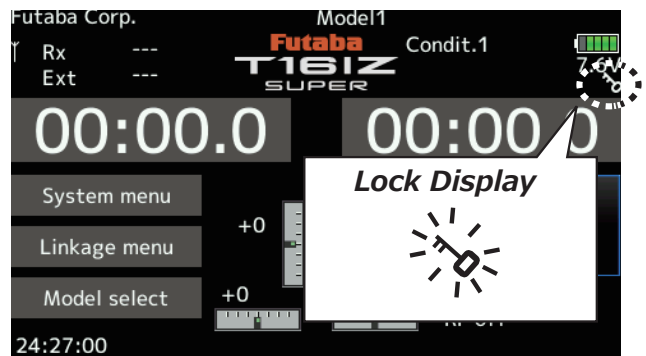
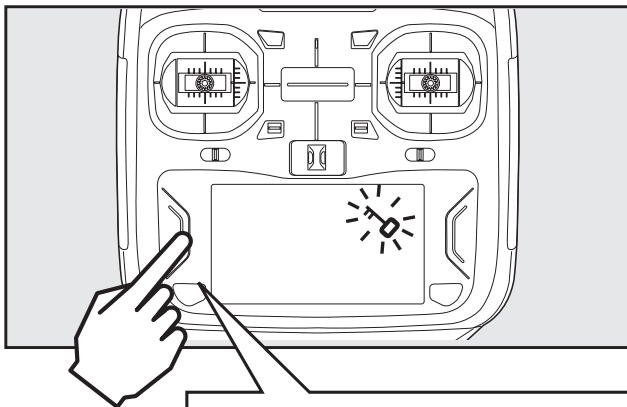

How to unlock

1. Press the Home/Exit button for about 1 second, and the display will then become unlocked.

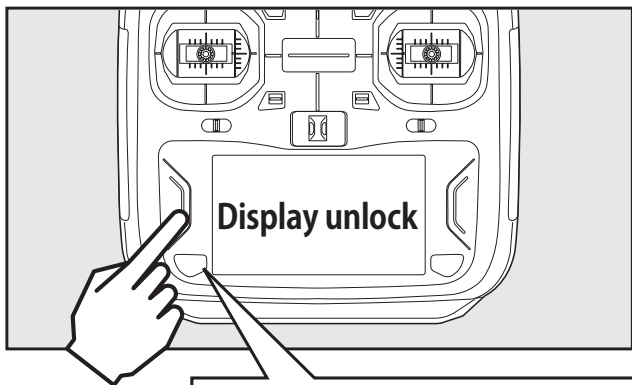

CAUTION

! The T161Z SUPER's touch screen is very sensitive. To avoid accidentally activating it during a flight, it is suggested that it be locked. Due to the touch screen's sensitivity, allowing it to be touched during flight by a neck strap hook, servo extension, or even your hand could be dangerous. Please use the Touch Display lock for added safety during flight.

RF off mode

Model operation is disabled, but display operation without RF signal output is allowed. (Reduces battery power consumption during set-up.)

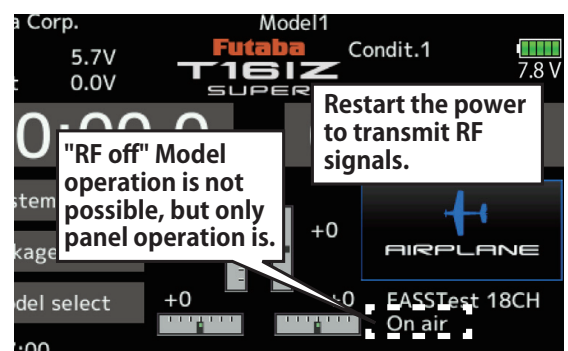
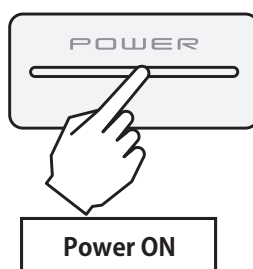
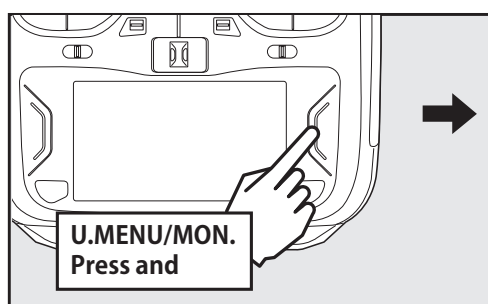

Switch (SA-SH)

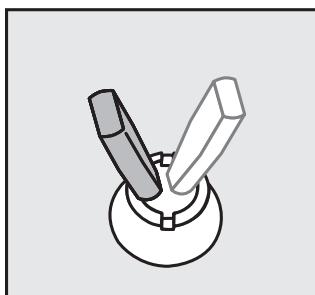
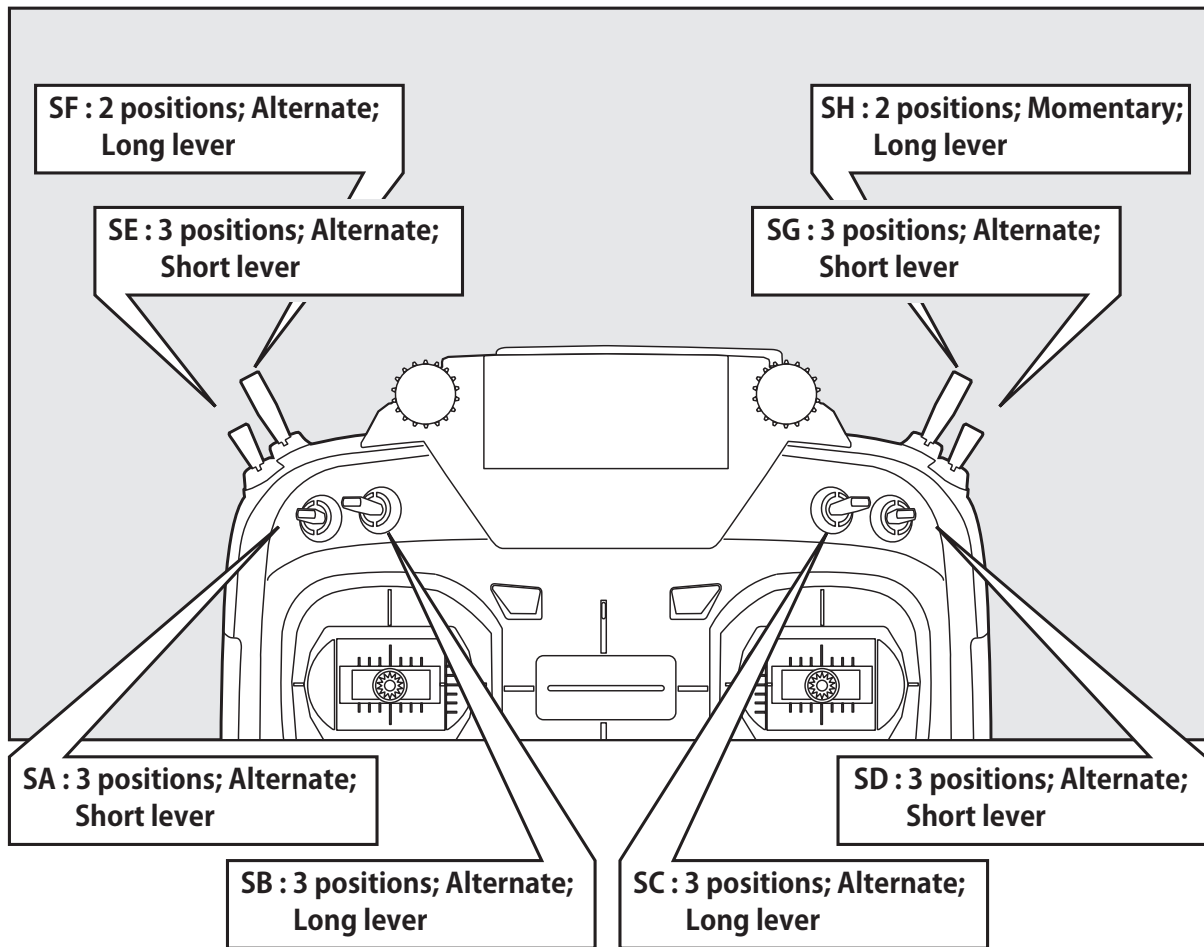

2 positions

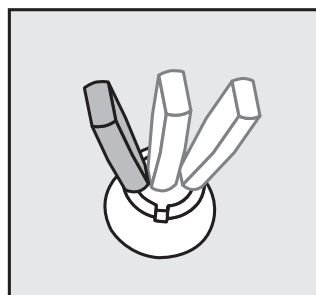

3 positions

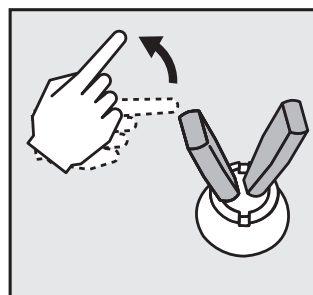

Alternate

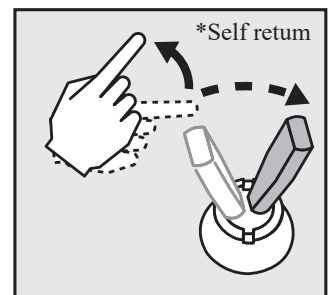

Momentary

Volume

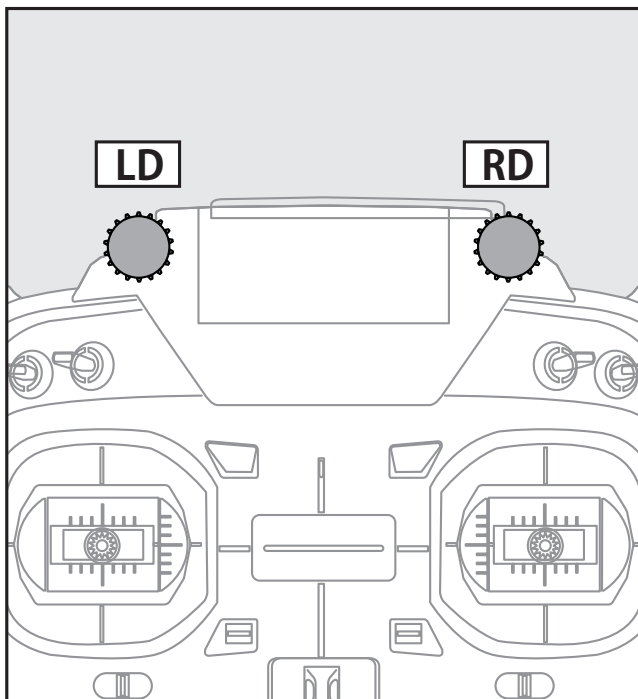

The volume LD and RD knobs allow analog input.

- *The T16IZ SUPER transmitter beeps when the volume knob reaches the center position.
- *You can use each setting screen of the mixing functions to select volumes and define the direction of movement.

Slider

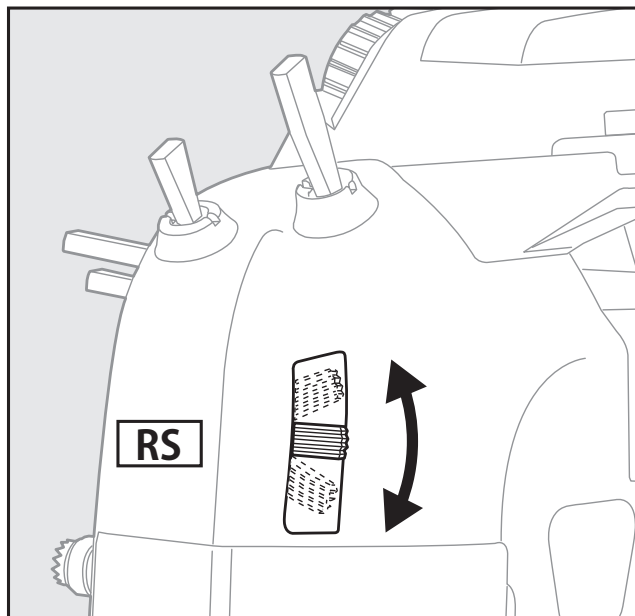
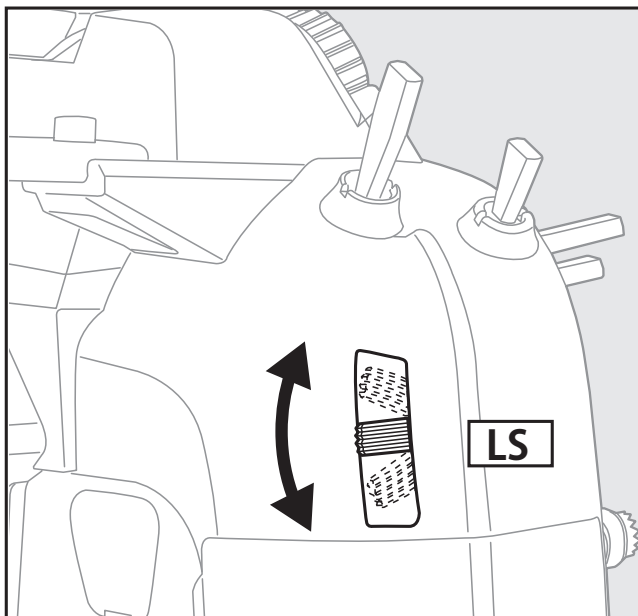

LS (Left), RS (Right):

The Linear Slider LS and RS offer analog input.

- *The T16IZ SUPER transmitter beeps when the lever comes to the center.
- *You can select a slide lever and set the movement direction on the setting screen of mixing functions.

Digital Trims T1-T4

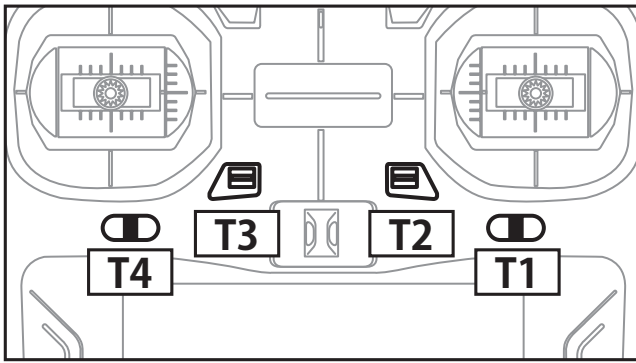

This transmitter is equipped with 4 digital trims. Each time you press a trim button, the trim position moves one step. If you continue pressing it, the trim position starts to move faster. In addition, when the trim position returns to the center, the tone will change. You can always monitor trim positions by referencing the LCD screen.

*You can select the trim step amount and the display unit on the home screen on the T1-T4 setting screen within the linkage menu.

Note: The trim positions you have set will be stored in the non-volatile memory and will remain there.

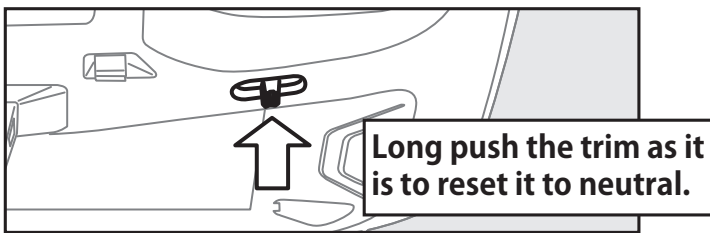

Digital trim operational example

*Example Stick Mode2

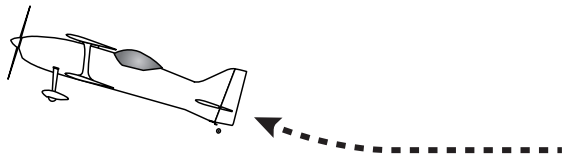

◆When the airplane goes up while the elevator stick is neutral.

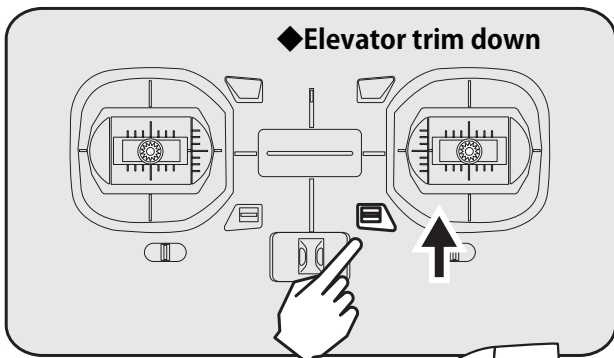

Elevator Neutral



Elevator Down

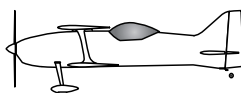
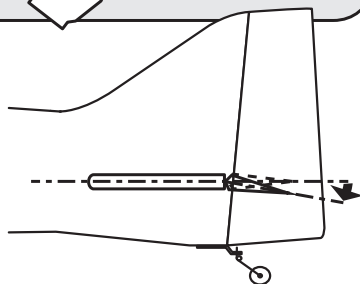

◆When the airplane dives while the elevator stick is neutral.

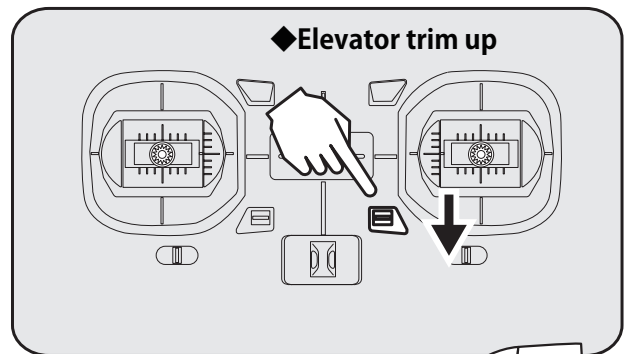

Elevator Neutral



Elevator Up

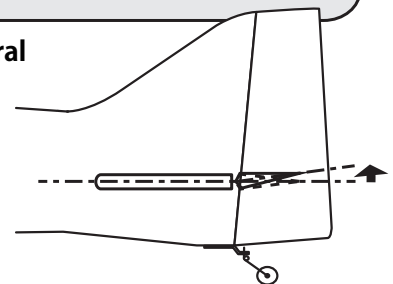

◆Adjust so that the airplane flies level.

Monitor LED Display

The status of the transmitter is displayed by LED indicators on the upper portion of the T161Z SUPER.

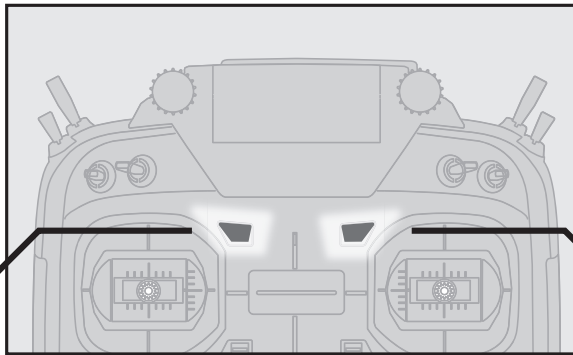

Red LED

- ◆ **ON** At startup
- ◆ **Blinking** Power switch is turned on with the throttle stick on the high side.
Power switch is turned on when any condition switch is activated (in the ON state).

Blue LED

- ◆ **ON** Radio waves are being transmitted.
- ◆ **OFF** Radio waves are in the OFF state.
- ◆ **Blinking (0.5 s)** Link mode
- ◆ **Blinking (1 s)** Range check mode

Stick Control

*Example Stick Mode2

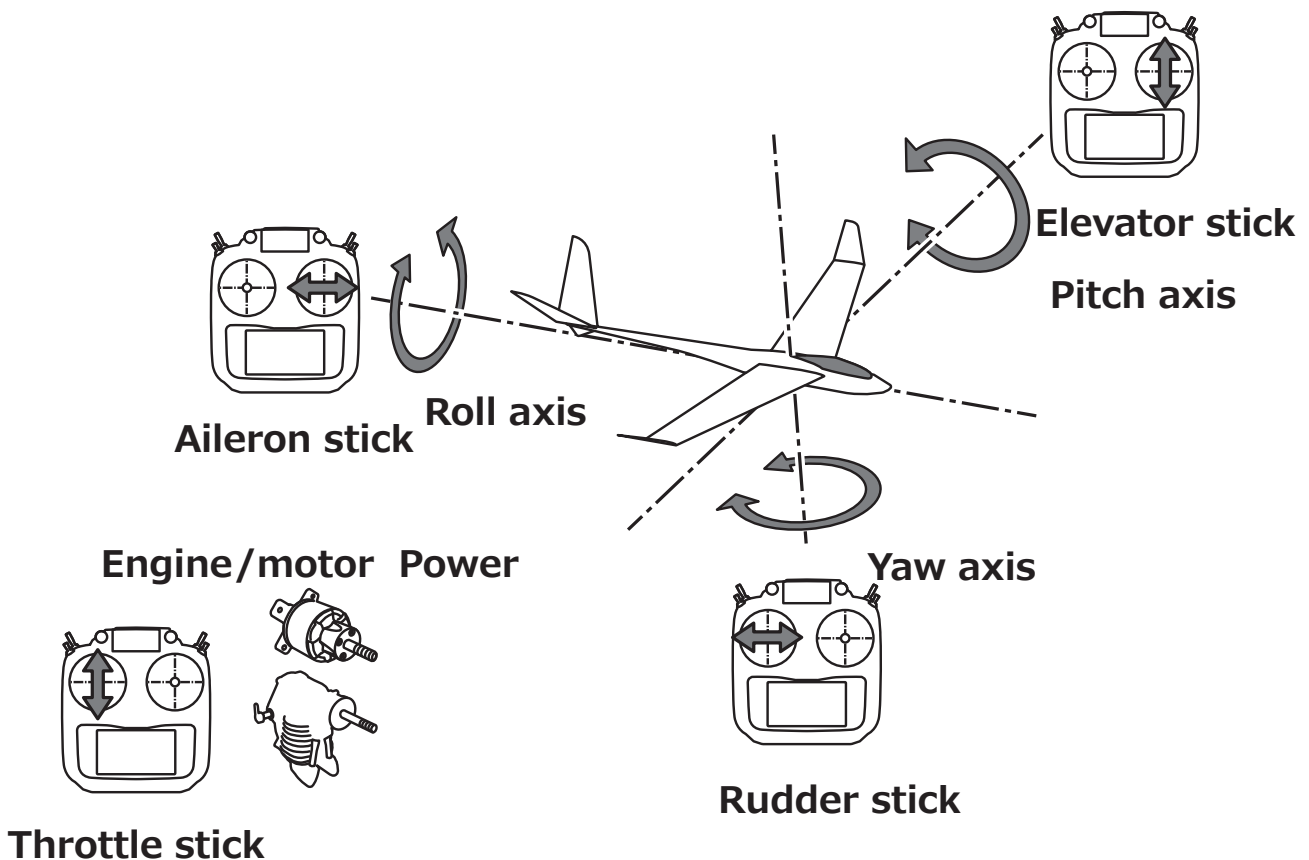

Stick control : Airplane Example

*Example Stick Mode2

A general model example. (There is also a different operational model.)

Roll Axis Control

Right roll
The right aileron is up.
The left aileron is down.

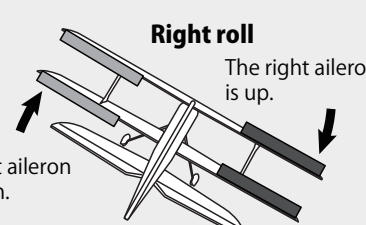

Aileron stick
↓
To the right



Level flight

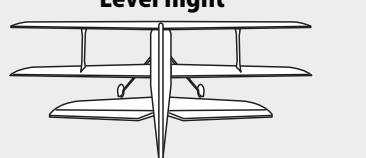

Neutral



Left roll
The right aileron is down.
The left aileron is up.

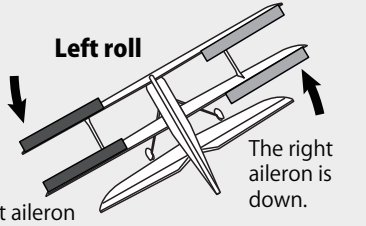

Aileron stick
↓
To the left



Pitch Axis Control

Nose Up

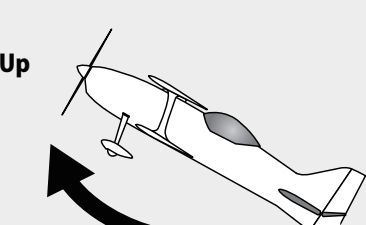

Elevator stick
↓
UP
(moved to the bottom)



Level flight

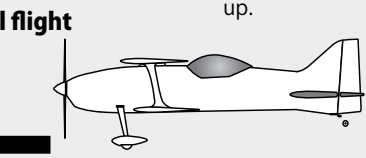

Neutral



Nose Down

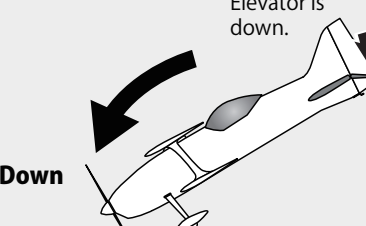

Elevator stick
↓
DOWN
(moved to the top)



Yaw Axis Control

Nose Right

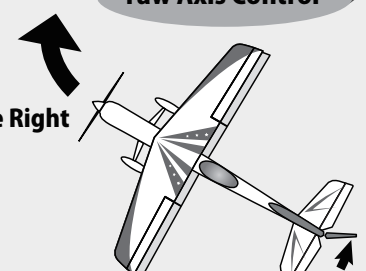

Rudder stick
↓
To the right



A rudder is right.

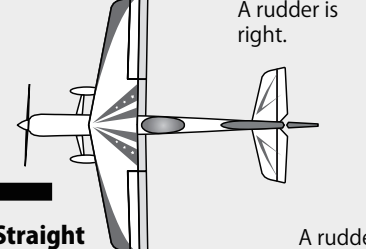

Neutral



Straight

Nose Left

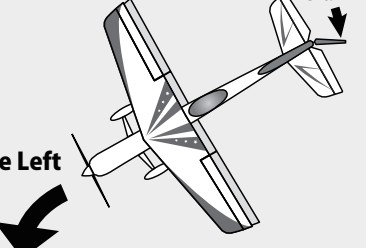

Rudder stick
↓
To the left



A rudder is left.

Throttle Control

High throttle

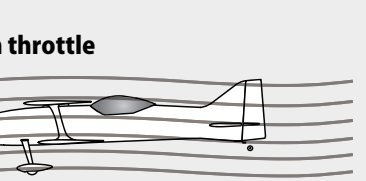

Throttle stick
↓
HIGHT
(moved to the top)



Middle

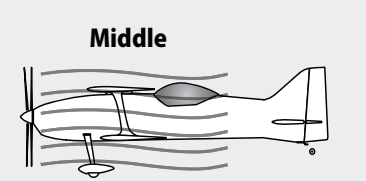

Throttle stick
↓
MIDDLE
(neutral)

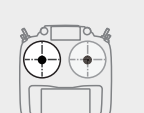

Low throttle

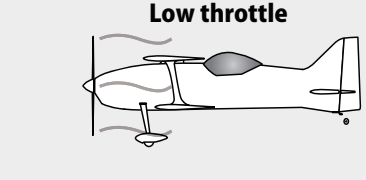

Throttle stick
↓
SLOW
(moved to the bottom)



Stick control : Helicopter Example

*Example Stick Mode2

A general model example. (There is also a different operational model.)

Roll Axis Control

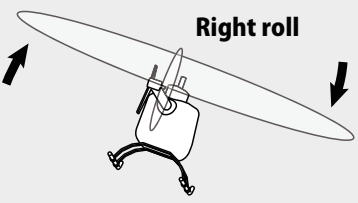
Right roll

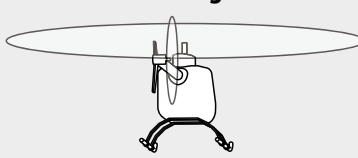
Aileron stick
To the right

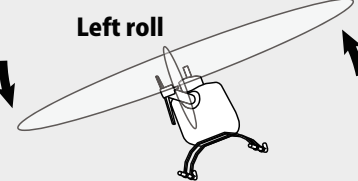
Level flight

Neutral

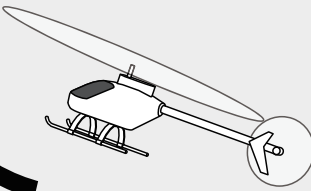
Left roll

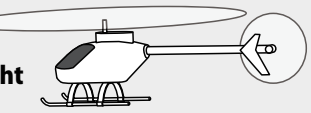
Aileron stick
To the left

Pitch Axis Control

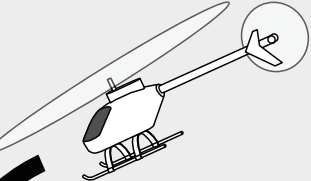
Nose Up

Elevator stick
UP
 (moved to the bottom)

Level flight

Neutral

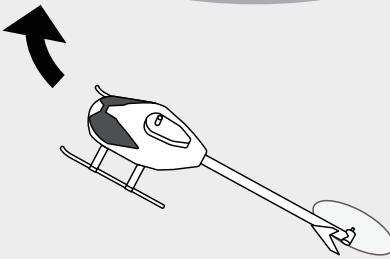
Nose Down

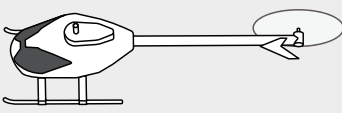
Elevator stick
DOWN
 (moved to the top)

Yaw Axis Control

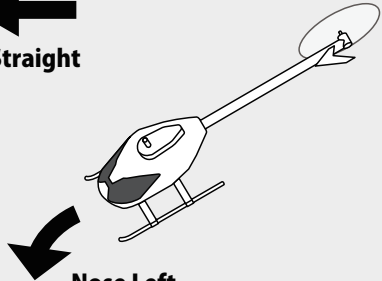
Nose Right

Rudder stick
To the right

Straight

Neutral

Nose Left

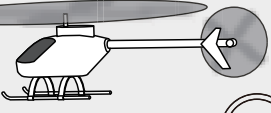
Rudder stick
To the left

Throttle /Pitch Control

Rise

Pitch Up **High**
Throttle stick
HIGHT
 (moved to the top)

Hovering

Throttle stick
MIDDLE
 (neutral)

Descent

Pitch Down **Middle**
Throttle stick
SLOW
 (moved to the bottom)

Stick control : Multicopter Example

*Example Stick Mode2

A general model example. (There is also a different operational model.)

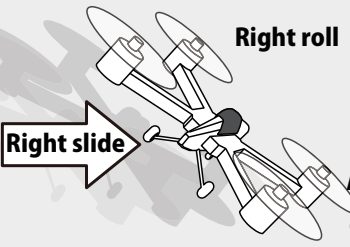
Roll Axis Control

Right roll
 Right slide →  Aileron stick ↓ To the right

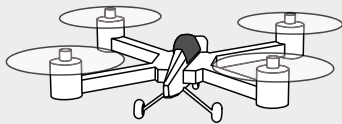
Hovering Level flight
 Neutral

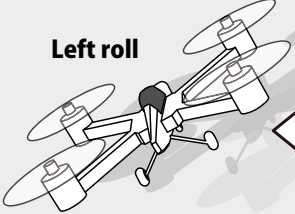
Left roll
 ← Left slide Aileron stick ↓ To the left

Pitch Axis Control

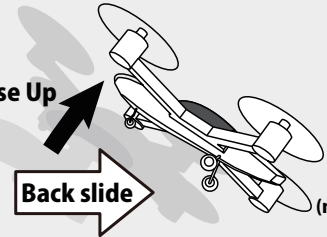
Nose Up
 Back slide →  Elevator stick ↓ UP (moved to the bottom)

Hovering Level flight
 Neutral

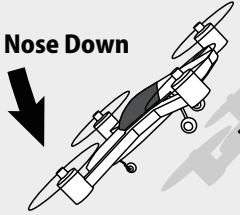
Nose Down
 Front slide → Elevator stick ↓ DOWN (moved to the top)

Yaw Axis Control

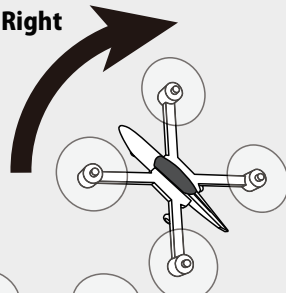
Nose Right
 Rudder stick ↓ To the right

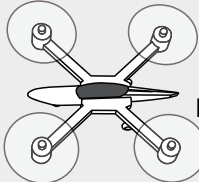
Hovering Level flight
 Neutral

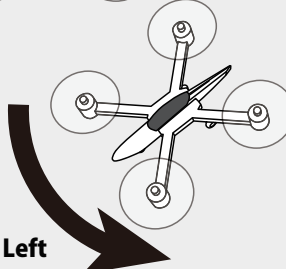
Nose Left
 Rudder stick ↓ To the left

Throttle Control

Rise
 ↑ Throttle stick ↓ HIGH (moved to the top)

Hovering
 Throttle stick ↓ MIDDLE (neutral)

Descent
 ↓ Throttle stick ↓ SLOW (moved to the bottom)

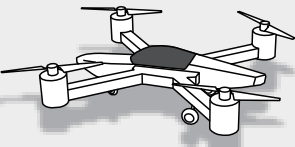
Stop

Stick Adjustment

Adjustment of the stick lever length

You can adjust the length of stick levers as you like. It is recommended to adjust the length of the sticks in line with your hand size.

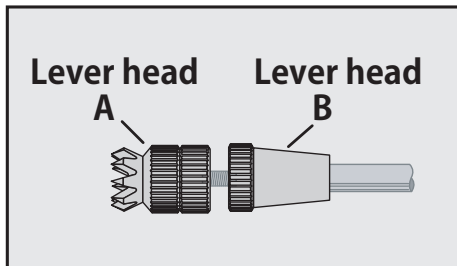

1. Hold the lever head "B" and turn the lever head "A" counter-clockwise. The lock will be released.
2. Turn the lever-head "A" clockwise as you hold the lever-head "B" after placing it as you like.

Adjustment of stick lever tension

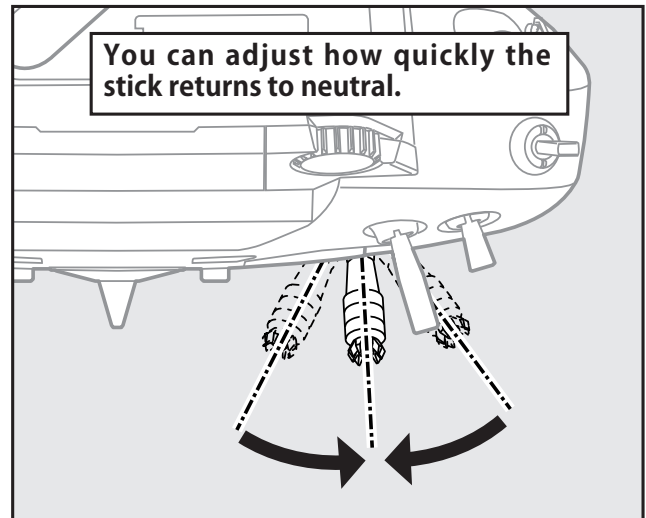

The tension of the self-return type stick lever can be adjusted.

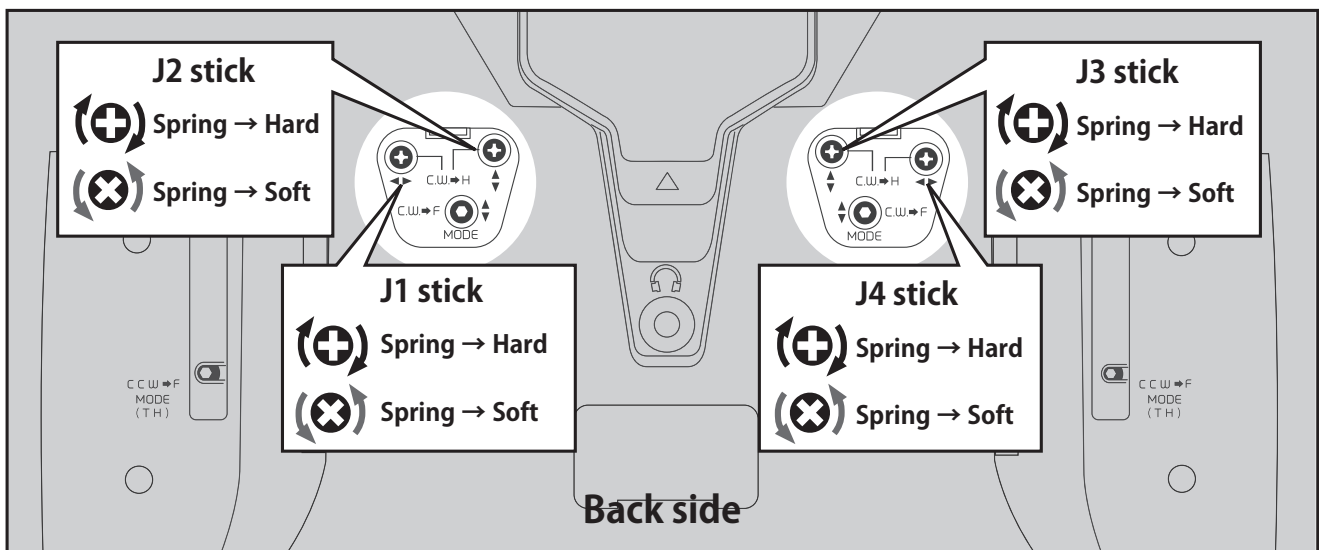

1. Use a screw driver to adjust the spring strength as you prefer by turning the adjusting screw of the stick you want to adjust.

*Turning the screw clockwise increases the tension.

CAUTION: Loosening the screw too much can interfere with the internal stick operation. The limit is 9 turns counterclockwise from the maximum position.

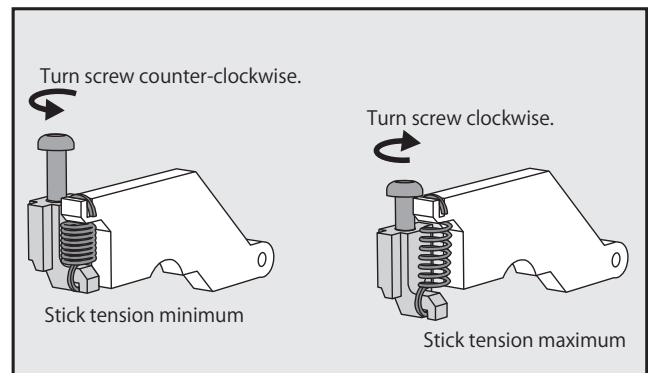

Stick Mode

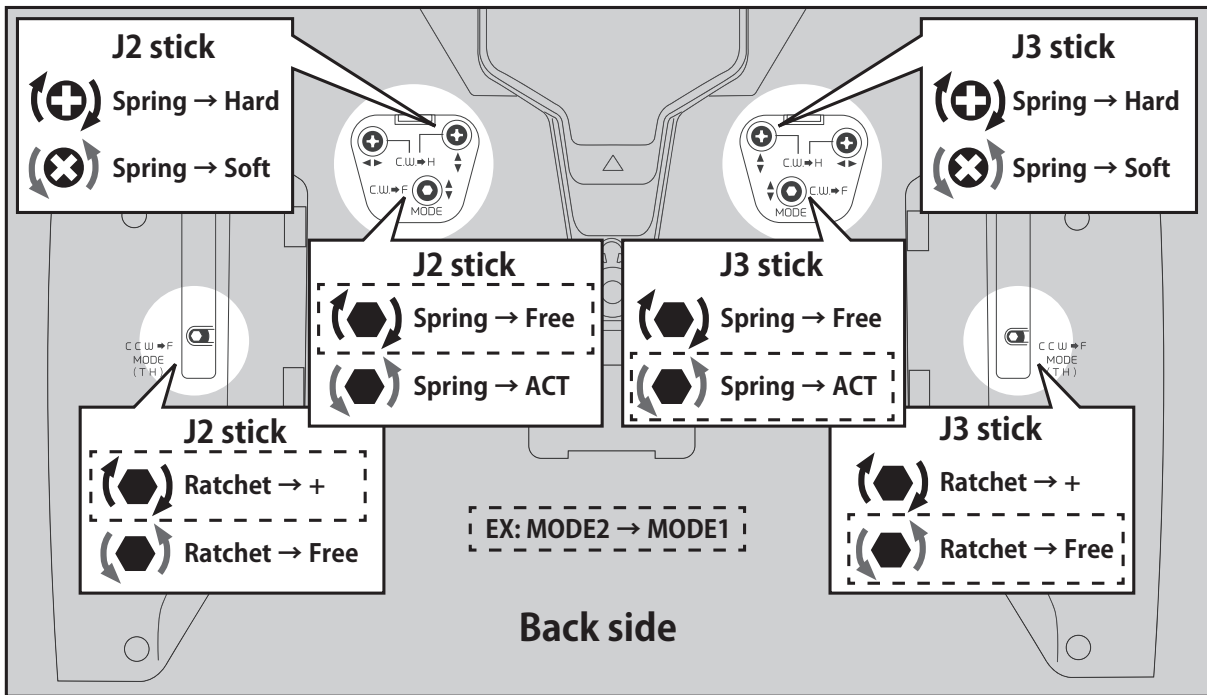
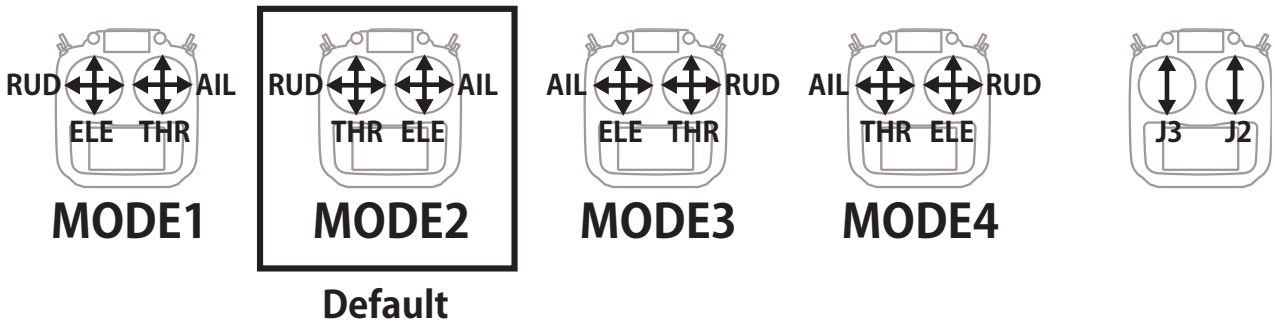

● System menu ⇒ H/W setting

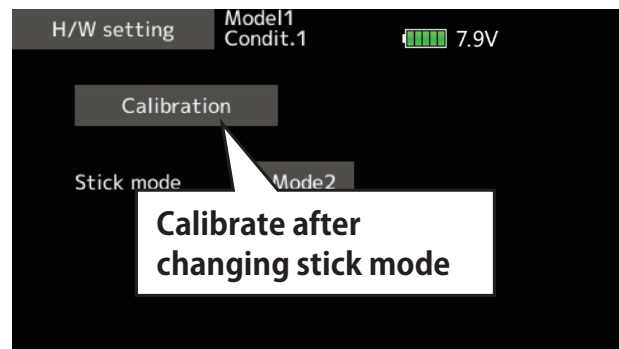
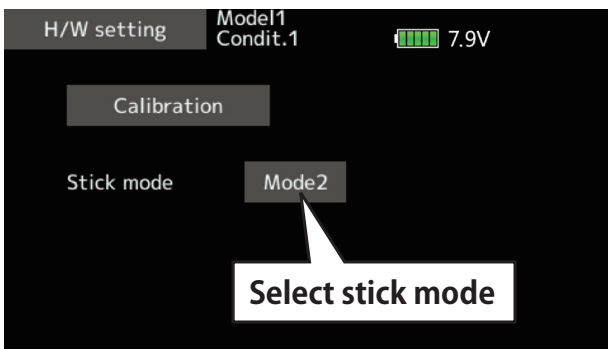

⚠ WARNING

- The changed stick mode will be reflected from the newly created model data.
- Change stick mode before entering model data.

- Before the flight, make sure that the operation of the stick matches the model operation.

microSD card (secure digital memory card) (not included)

The T16IZ SUPER transmitter model data can be stored by using any commonly found microSD card. When T16IZ SUPER update software is released, the software is updated using a microSD card. The T16IZ SUPER is capable of using SD and SDHC cards (SD:32MB-2GB SDHC:4GB-32GB).

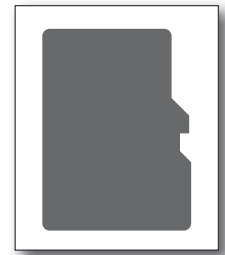

microSD card reader/writer

Saving model data and update files (released from Futaba) into the microSD card, you can use those files on your T16IZ SUPER transmitter. Equipment for reading and writing microSD cards is available at most electronics stores.

Inserting/removing the microSD card

- 1) Rotate the antenna.

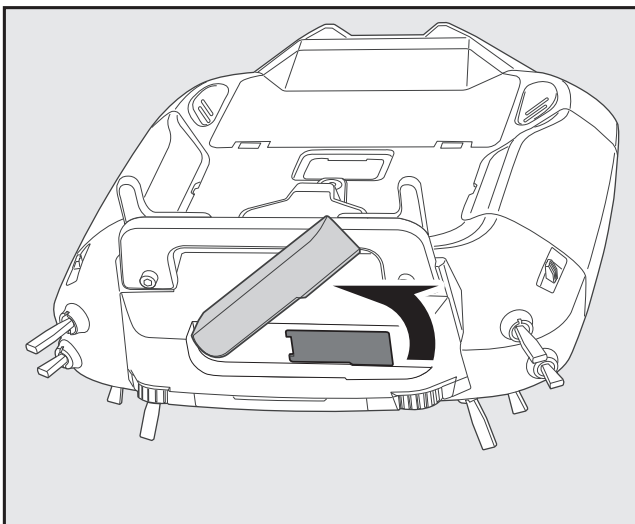

Stored data

When you have a problem of saving or reading data after a long period of use, please get a new microSD card.

*We are not responsible for, and offer no compensation for, memory card data that fails or is damaged for any reason. Be sure to keep a backup of all important data stored in your microSD card.

- 1) Open the rubber cover and insert the microSD card into the SD card slot.

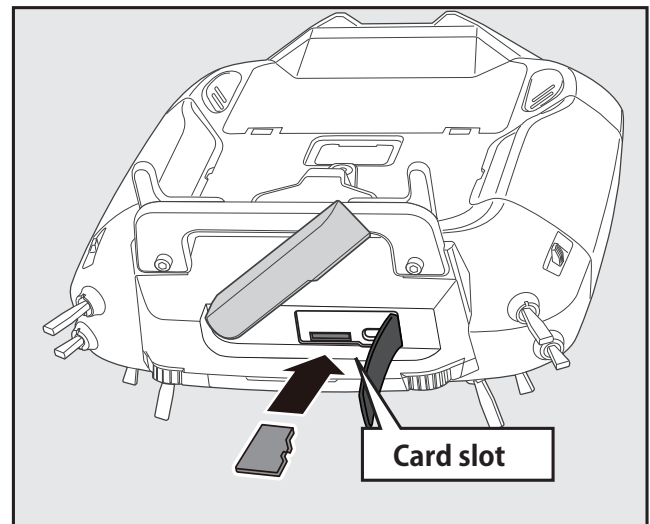

- 1) When the microSD card is pressed in once again, the card will be released from the card slot and can be removed.

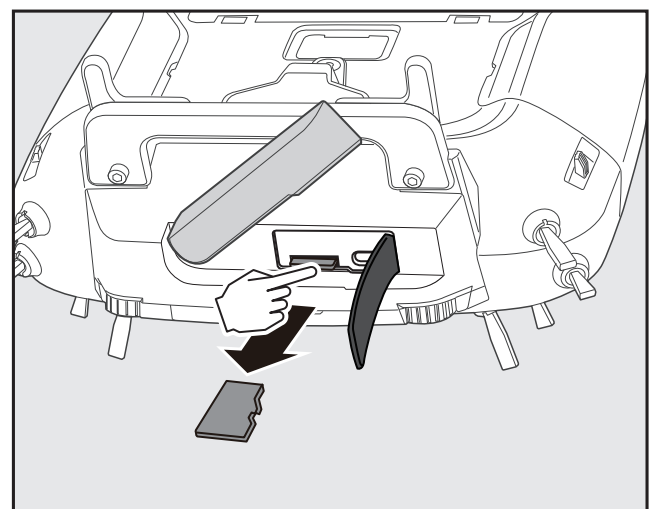
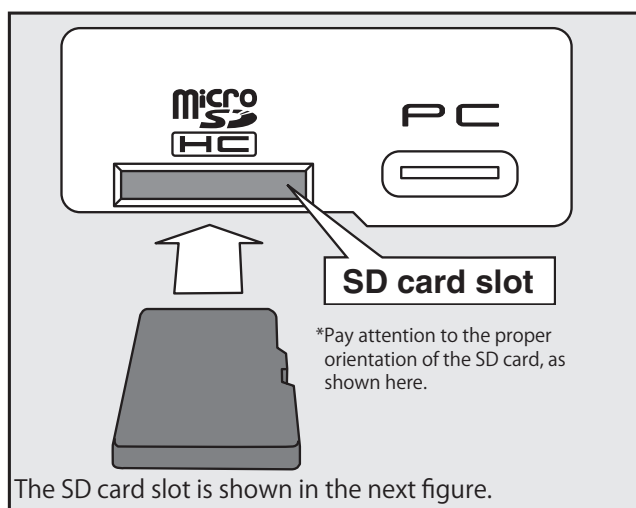

-When a microSD card is installed in the T16IZ SUPER transmitter, a folder called "Futaba" is created. Folders called "LOG" and "MODEL" are created in this folder. The "MODEL" folder stores the model data and the "LOG" folder stores the telemetry log data.

-The telemetry log data recorded on the microSD card can be converted to CSV format by the telemeter log converter released on our home page. When copying or moving a log file, always select both .FLI and .FLD file.

⚠ CAUTION

! Be sure to turn off the power to the transmitter before inserting or removing the microSD card.

⊘ As the microSD card is a precision device, do not use excessive force when inserting.

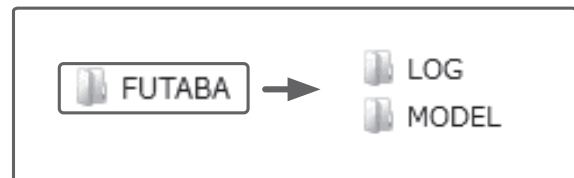

Connector/Plug

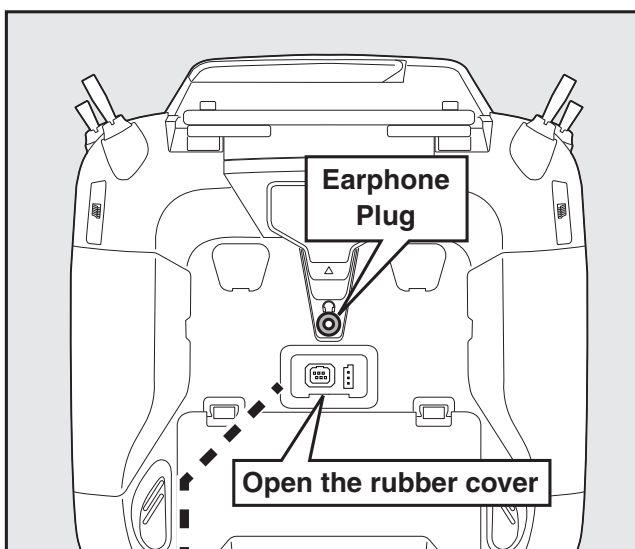

Earphone plug

Connecting a stereo headphone to this plug, the speech information of telemetry can be heard.

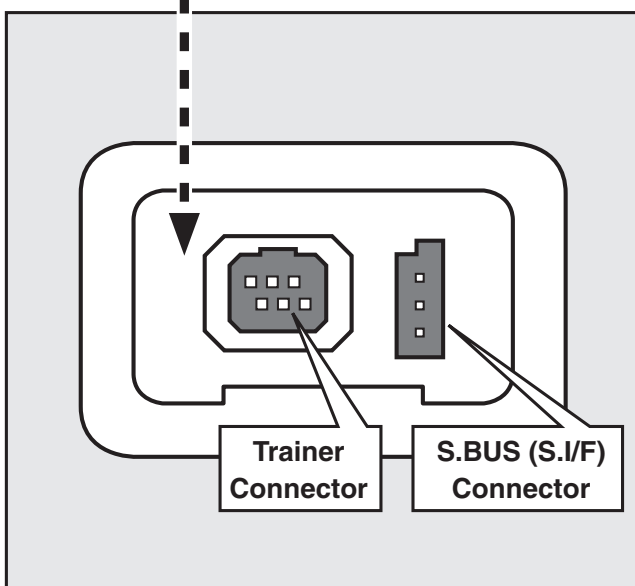

S.BUS connector (S.I/F)

When using an S.BUS servo and telemetry sensor, connect them both here.

Connector for trainer function

When you use the trainer function, connect the optional trainer cable between the transmitters for teacher and student.

*You can set the trainer function on the Trainer Function screen in the System menu.

Receiver Nomenclature

Before using the receiver, be sure to read the precautions listed in the following pages.

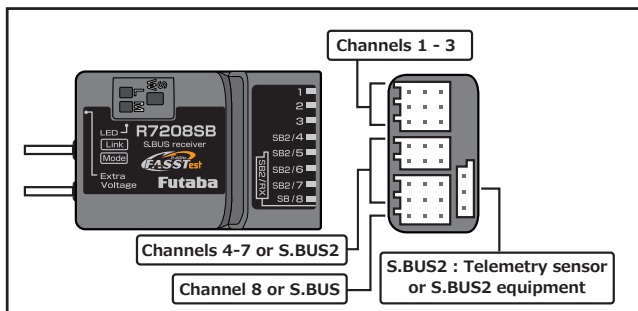

Connector

"1 through 3": outputs for the channels 1 through 3

"SB2/4-7": for the channels 4 through 7 or S.BUS2 port.

"SB/8": outputs of 8 channels or S.BUS port.

[S.BUS Servo S.BUS Gyro] →

"S.BUS2/RX": outputs of S.BUS2 port.

[Telemetry Sensor] →

*Connect the battery to the free port.

*When using nine or more channels, use an S.BUS function or use a second R7208SB or R7308SB and link both to your transmitter.

*The R7208SB/7308SB has a port switching function. If SB2/4 to SB2/7 ports are also set to S.BUS2, sensors can be connected.

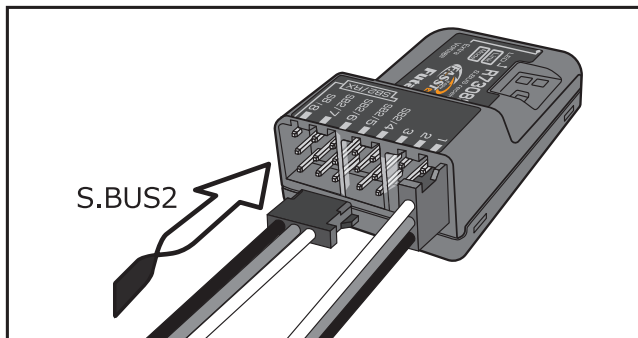

Connector insertion

Firmly insert the connector in the direction shown in the figure. Insert the S.BUS2 by turning it 90 degrees.

⚠ WARNING

S.BUS2 connectors

❗ Don't connect an S.BUS servo/gyro to S.BUS2 connector.

MODE LED Monitor

This monitor is used to check the CH mode of the receiver.

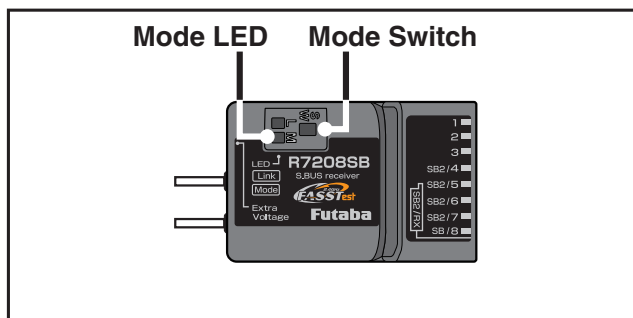

Mode Switch

Use the small plastic screw driver that was included with your receiver. (The button is not used to link the transmitter and receiver together.)

- * CH mode selection
- * FASSTest12CH (telemetry OFF) mode setting
- * Dual RX Link mode setting

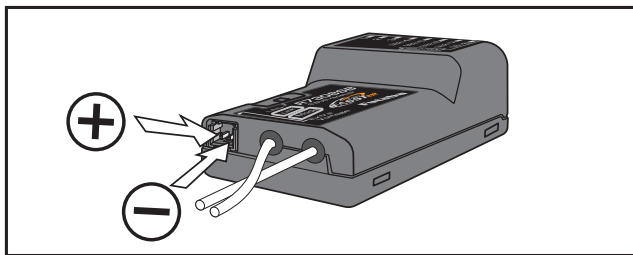

Extra Voltage Connector

Use this connector when using a voltage telemetry device to send the battery voltage information (DC 0 ~ 70 V) from the receiver to the transmitter.

Please use the External voltage input cable. (UBB0141) This connects directly to your main motor batteries.

⚠ DANGER

⊘ Don't touch wiring.

* There is a danger of receiving an electric shock.

⊘ Do not short-circuit the battery terminals.

* A short circuit across the battery terminals may cause abnormal heating, fire and burns.

⊘ Please double check your polarity (+ and -) when hooking up your connectors.

* If + and - of wiring are mistaken, it will damage, ignite and explode.

⊘ Don't connect to Extra Voltage before turning on a receiver power supply.

Connection of a receiver battery

⚠ WARNING

- ⊘ Please make sure that you use a battery that can deliver enough capacity for the number and kind of servos used. Dry batteries cannot be used.

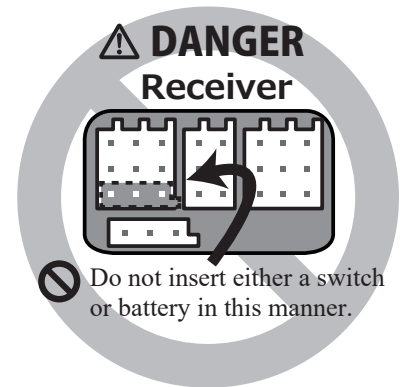
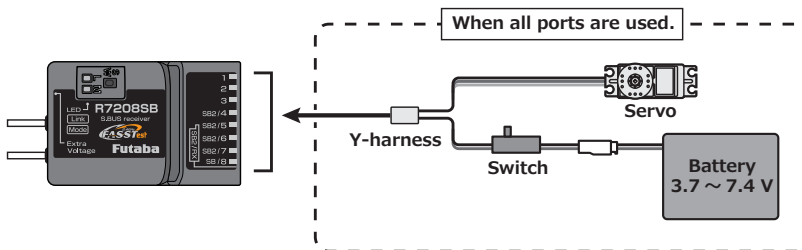
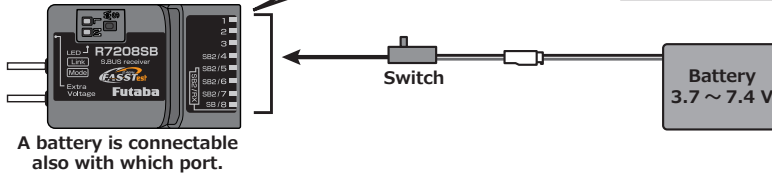
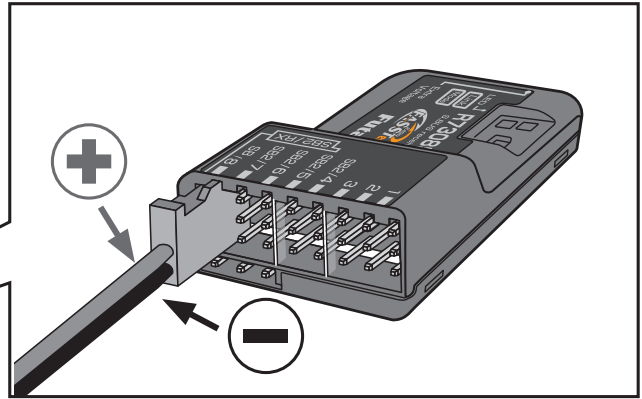

Connection example

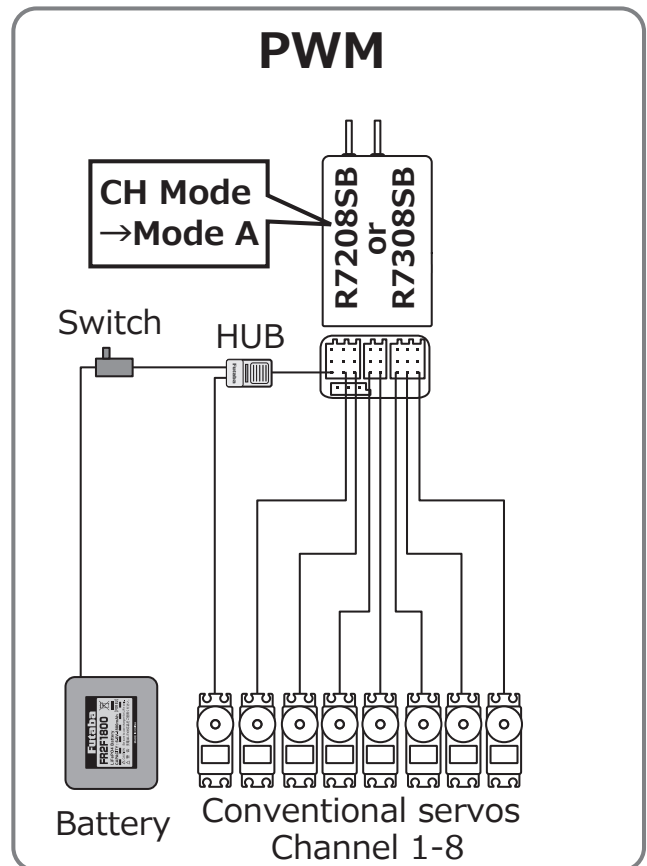
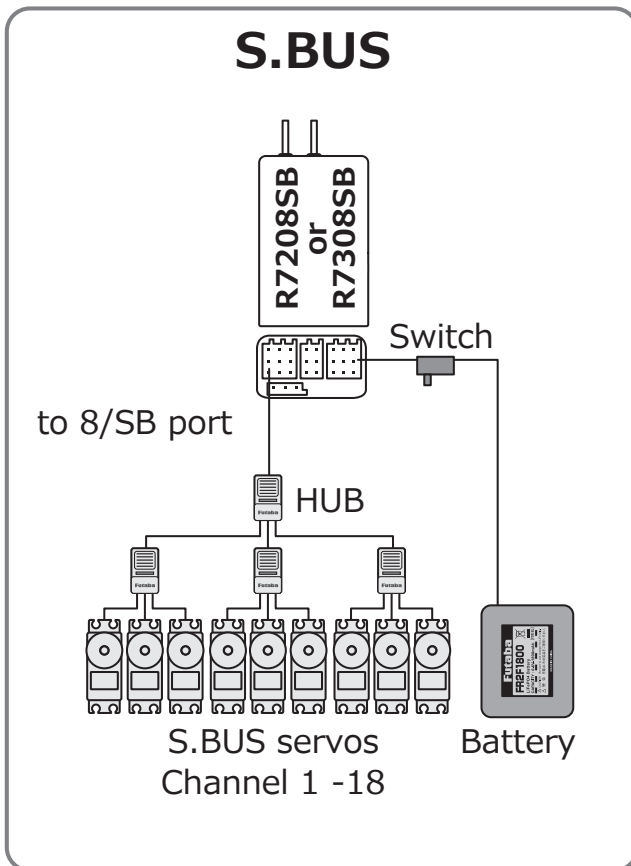

⚠ WARNING Power supply

- ⊘ Please make sure that you use a battery that can deliver enough capacity for the number and kind of servos used. Alkaline batteries cannot be used.

LED Indication

LED Indication

Status	LINK LED
No signal reception	Red Solid
Receiving signals	Green Solid
Waiting for link	Start → 2second later → Red Blink (3 second)
Unrecoverable error (EEPROM, etc.)	Red Green Alternate blink



In Dual RX Link Mode

Status	MODE LED
External receiver is receiving error or not connected. S.BUS signal not received	Red Solid
S.BUS signal reception from external receiver (also received by external receiver)	Green Solid



In FASSTest12CH Telemetry OFF Mode

Status	LINK LED
Start	Orange Solid



Channel Modes

The R7208SB/R7308SB is capable of changing its channel allocations as described in the table below. This is especially important when using the receiver in a dual receiver mode. See your transmitter operation manual for complete details on operating in the dual receiver mode.

R7208SB/R7308SB CH Mode table

Output connector	Channel						
	Mode A CH 1-8	Mode B CH 1-7	Mode C CH 1-6	Mode D CH 1-3	Mode E CH 9-16	Mode F CH 9-15	Mode G CH 9-14
1	1	1	1	1	9	9	9
2	2	2	2	2	10	10	10
3	3	3	3	3	11	11	11
SB2 / 4	4	4	4	S.BUS2	12	12	12
SB2 / 5	5	5	5	S.BUS2	13	13	13
SB2 / 6	6	6	6	S.BUS2	14	14	14
SB2 / 7	7	7	S.BUS2	S.BUS2	15	15	S.BUS2
SB / 8	8	S.BUS	S.BUS	S.BUS	16	S.BUS	S.BUS
LED blink	RED 1	RED 2	RED 3	RED 4	RED 5	GREEN 1	GREEN 2



Default

- 1 Turn on the receiver. [Transmitter is always OFF]
- 2 Press and hold the SW for 5 seconds to 10 seconds.
- 3 When the LED of the receiver changes from blinking red to blinking orange, SW is released.
- 4 The LED should now blink red two times in the patterns described in the chart below.
- 5 Each press of the SW advances the receiver to the next mode.
- 6 When you reach the mode that you wish to operate in, press and hold the SW for more than 2 seconds. When LED blinks in orange, it is the completion of a mode change, SW is released.
- 7 Cycle the receiver power off and back on again after changing the Channel mode.

Check	LINK LED
1 Turn on the receiver. [Transmitter is always OFF]	Red Solid
2 Receiver enters link waiting state	Start → 2second later → Red Blink (3 second)
3 The LED will flash for the current CH output mode.	Current CH mode display

Dual Rx Link System

By installing two receivers in one aircraft, if one receiver becomes unable to communicate, the other receiver can be operated.

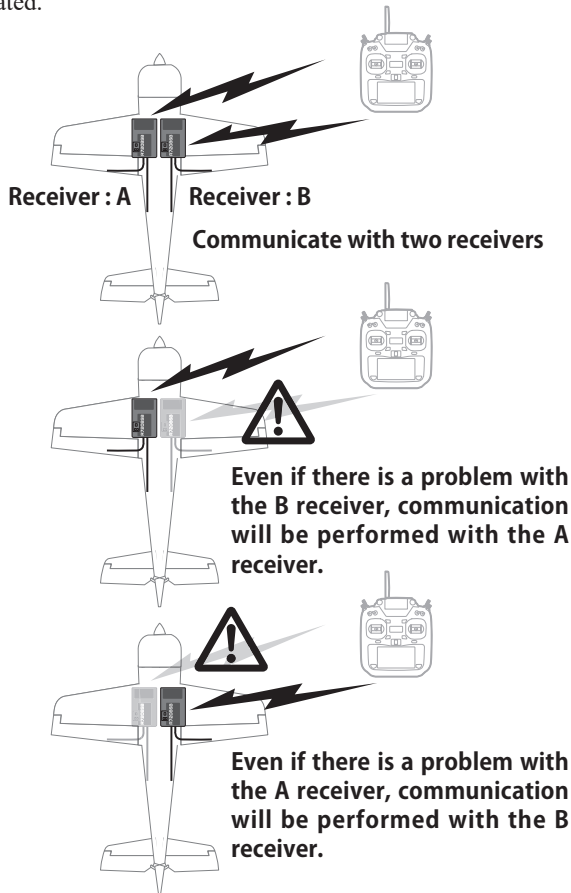

In Dual RX link mode, the SB2/RX port is for reception only, so use CH mode B, C, D, F, G mode for S.BUS output and S.BUS2 input/output.

Connection example

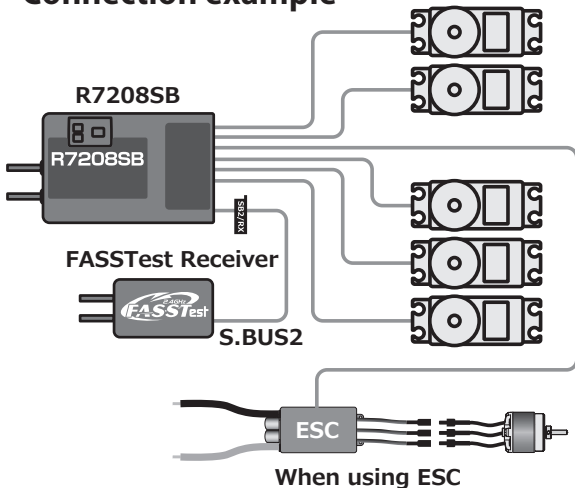

How to change to Dual RX Link mode

- 1 Turn on the receiver. [Transmitter is always OFF]
- 2 Press and hold the SW for 5 seconds or more.

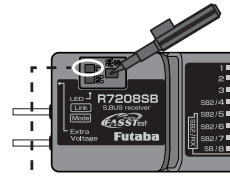

Blinking switches every 5 seconds as follows.



- 3 Release the switch here

If it is passed, turn off the power and restart

Blinks GREEN once



Dual RX Link mode : OFF

Press SW once more to return to flashing green once

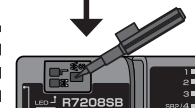

- 4 Press switch

Blinks GREEN twice



Dual RX Link mode : ON

- 5 Press and hold the SW

Blinks ORANGE



- 6 Release SW

Solid ORANGE



- 7 Turn off the receiver power



After restarting, the MODE LED lights up.



Status	MODE LED
External receiver is receiving error or not connected. S.BUS signal not received	Red Solid
S.BUS signal reception from external receiver (also received by external receiver)	Green Solid

FASSTest12CH(Telemetry OFF) mode

This mode is forcibly turning off telemetry transmission to prevent collision of telemetry signals from the receiver to the transmitter when using dual RX link mode in FASSTest12ch mode.

- 1 Turn on the receiver. [Transmitter is always OFF]
- 2 Press and hold the SW for 5 seconds or more.

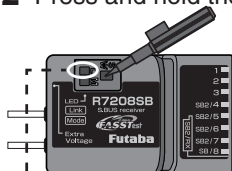

Blinking switches every 5 seconds as follows.

RED → ORANGE → GREEN → ORANGE slow blink

**FASSTest12CH
(Telemetry OFF)
mode : INH**

Press SW once more
to return to flashing
orange once

**FASSTest12CH
(Telemetry OFF)
mode : ACT**

- 3 Release the switch here

Blinks ORANGE once

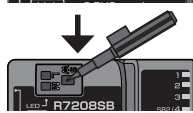

- 4 Press switch

Blinks ORANGE twice

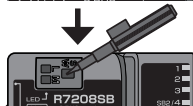

- 5 Press and hold the SW

Blinks ORANGE

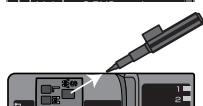

- 6 Release SW



Solid ORANGE

- 7 Turn off the receiver power

Change to this
mode when using
FASSTest12CH in
dual RX link mode.



After restarting, the
LINK LED lights up.

In FASSTest12CH Telemetry OFF Mode

Status	LINK LED
Start	Orange Solid



How to Dual Rx Link

- 1 Install two receivers on the aircraft as shown in the connection example.
- 2 Link the two receivers using the dual receiver feature of the transmitter.
 - For systems without dual receiver capability, link each receiver in turn.

Transmitter in link mode

For FASSTest 18CH Select dual mode and link primary

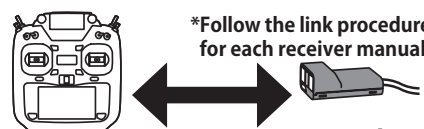

*Follow the link procedure
for each receiver manual.

Turn on the main
receiver and link

Transmitter in link mode

For FASSTest 18CH Select dual mode
and link secondary

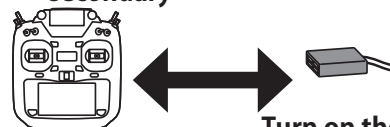

Turn on the sub
receiver and link

◆ About telemetry system

When using the dual receiver function

- The telemetry function of the main receiver can be used
- Sub-receiver telemetry function is not available

Telemetry for FASSTest12CH

In FASSTest12CH mode, after linking R7208SB/R7308SB in telemetry OFF mode, link the receiver you want telemetry. (The transmitter will show the telemetry of the last linked transmitter.)

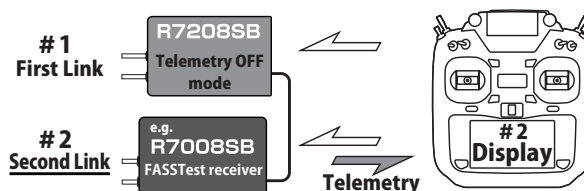
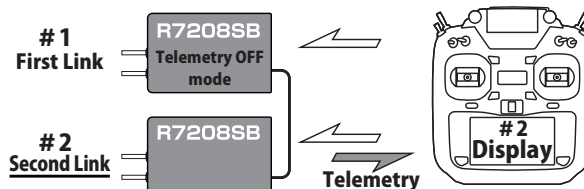

- # 2 Telemetry display of second-linked receiver.
- # 1 Telemetry OFF first-Linked receiver.

Mounting the Servo

*Servo is not included in this set.

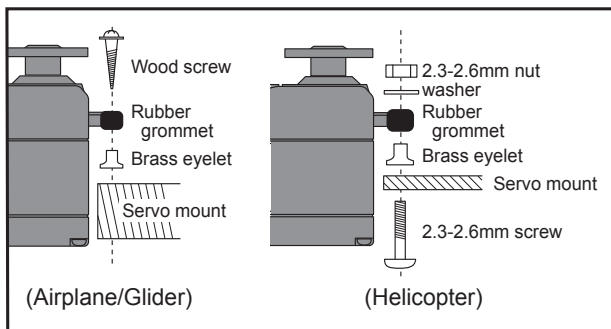

Servo lead wires

To prevent the servo lead cable from being broken by vibration during flight, provide a little slack in the cable and fasten it at suitable points. Periodically check the cable during daily maintenance.

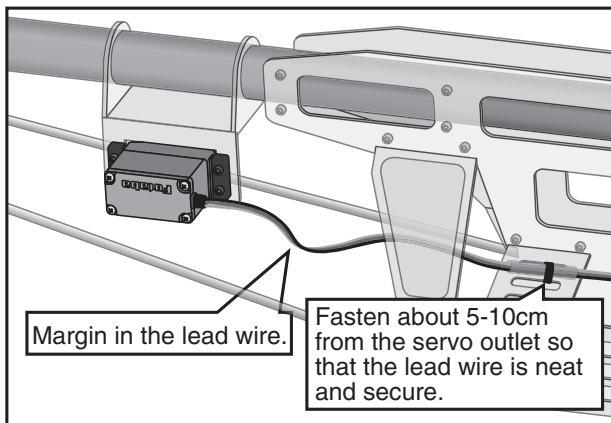

Mounting the power switch

*Switch is not included in this set.

When mounting a power switch to an airframe, make a rectangular hole that is a little larger than the total stroke of the switch so that you can turn the switch ON/OFF without binding.

Avoid mounting the switch where it can be covered by engine oil and dust. In general, it is recommended to mount the power switch on the side of the fuselage that is opposite the muffler.

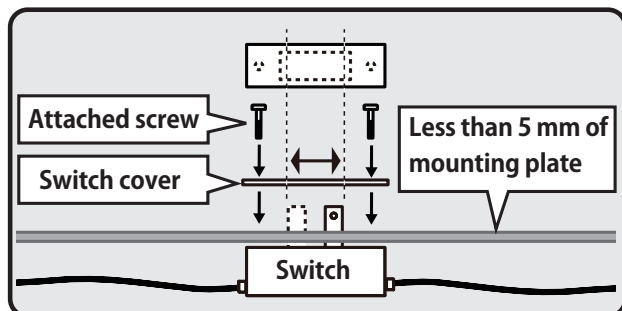

Safety precautions when you install receiver and servos.

⚠ WARNING

Connecting connectors

- ⚠ Be sure to insert the connector until it stops at the deepest point.

How to protect the receiver from vibration and water

- ⚠ Wrap the receiver with something soft such as foam rubber to avoid vibration. If there is a chance of getting wet, put the receiver in a waterproof bag or balloon.

Receiver's antenna

- ⊘ Never cut the receiver's antenna. Do not bind the receiver's antenna with the cables for servos.
- ⚠ Locate the receiver's antenna as far as possible from metals or carbon fiber components such as frames, cables, etc.

*Cutting or binding the receiver's antenna will reduce the radio reception sensitivity and range, and may cause a crash.

Servo throw

- ⚠ Adjust your system so that pushrods will not bind or sag when operating the servos to the full extent.

*If excessive force is continuously applied to a servo, the servo could be damaged due to force on the gear train and/or power consumption causing rapid battery drain.

Mounting servos

- ⚠ Use a vibration-proof rubber (such as rubber grommet) under a servo when mounting the servo on a servo mount. And be sure that the servo cases do not touch directly to the metal parts such as servo mount.

*If the servo case contacts the airframe directly, vibration will travel to and possibly damage the servo.

S.BUS/S.BUS2 Installation

This set uses the S.BUS/S.BUS2 system. The wiring is as simplified and clean mounting as possible, even with models that use a large number of servos. In addition, the wings can be quickly installed to the fuselage without any erroneous wiring by the use of only one simple wire, even when there are a large number of servos used.

- When using S.BUS/S.BUS2, special settings and mixes in your transmitter may be unnecessary.
- The S.BUS/S.BUS2 servos memorize the number of channels themselves. (settable with the T16IZ SUPER)
- The S.BUS/S.BUS2 system and conventional system (receiver conventional CH used) can be mixed.

S.BUS Glider usage example

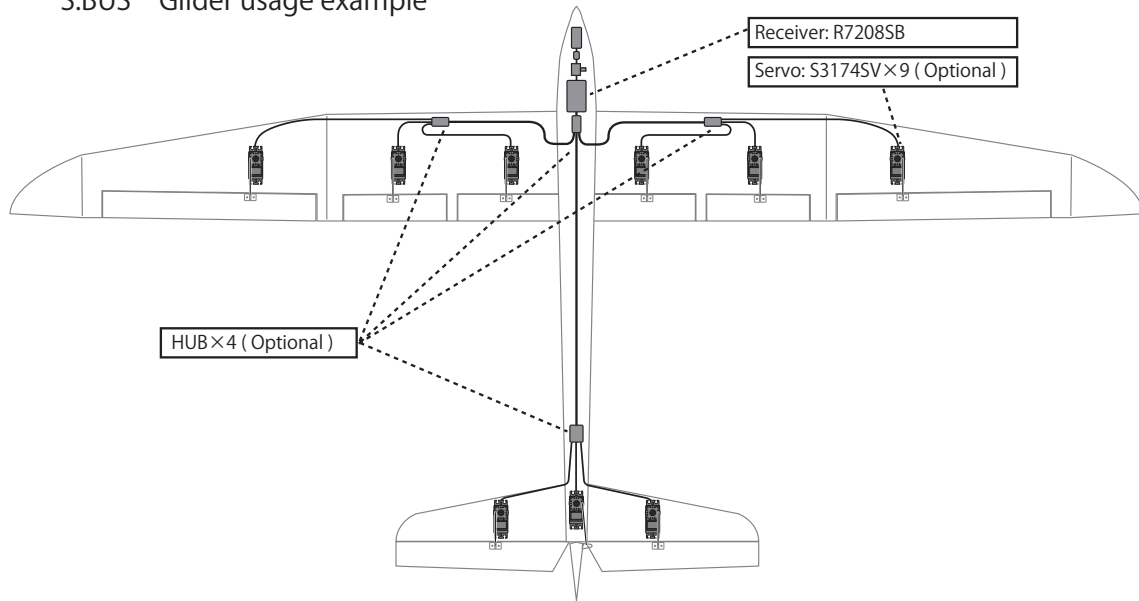

S.BUS Aerobatic plane usage example

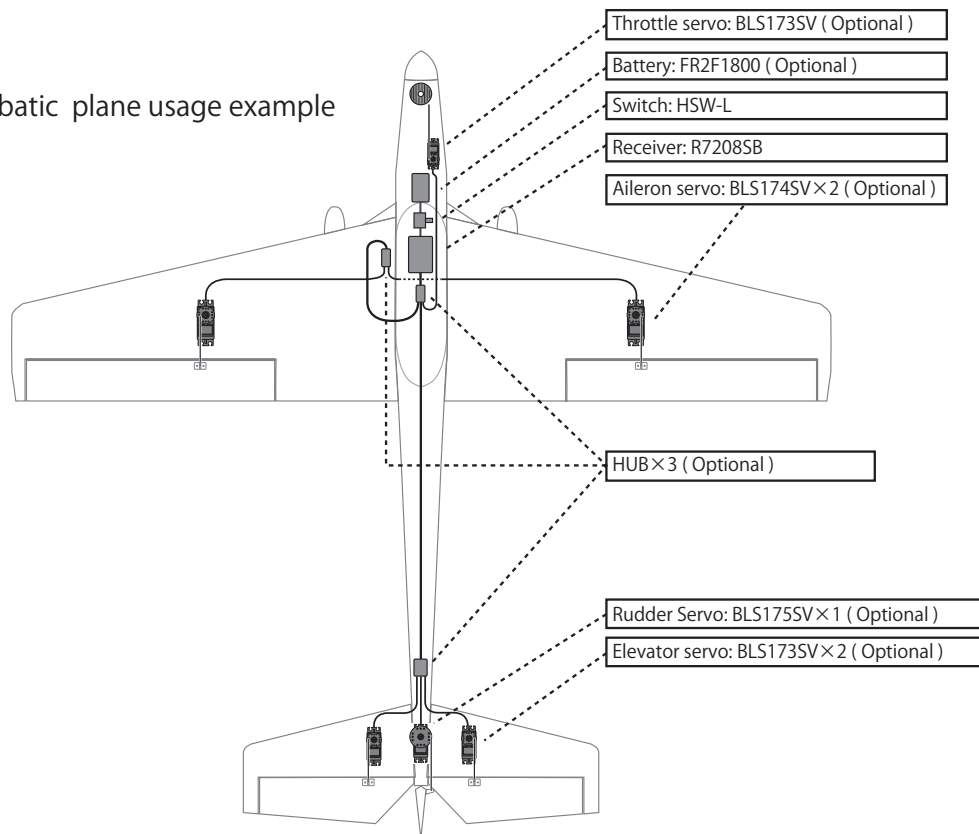

S.BUS2 System

When using the S.BUS2 port, an impressive array of telemetry sensors may be utilized.

S.BUS2 TABLE

Receiver port	S.BUS Servo S.BUS Gyro	S.BUS2 Servo S.BUS2 Gyro	Telemetry sensor
S.BUS	○	○	×
S.BUS2	×	○	○

(※) **Don't connect S.BUS Servo, S.BUS Gyro to S.BUS2 connector.**

S.BUS servos and gyros and S.BUS2 servos and gyros must be used in the correct receiver ports. Please refer to the instruction manual to make sure you connect to the correct one.

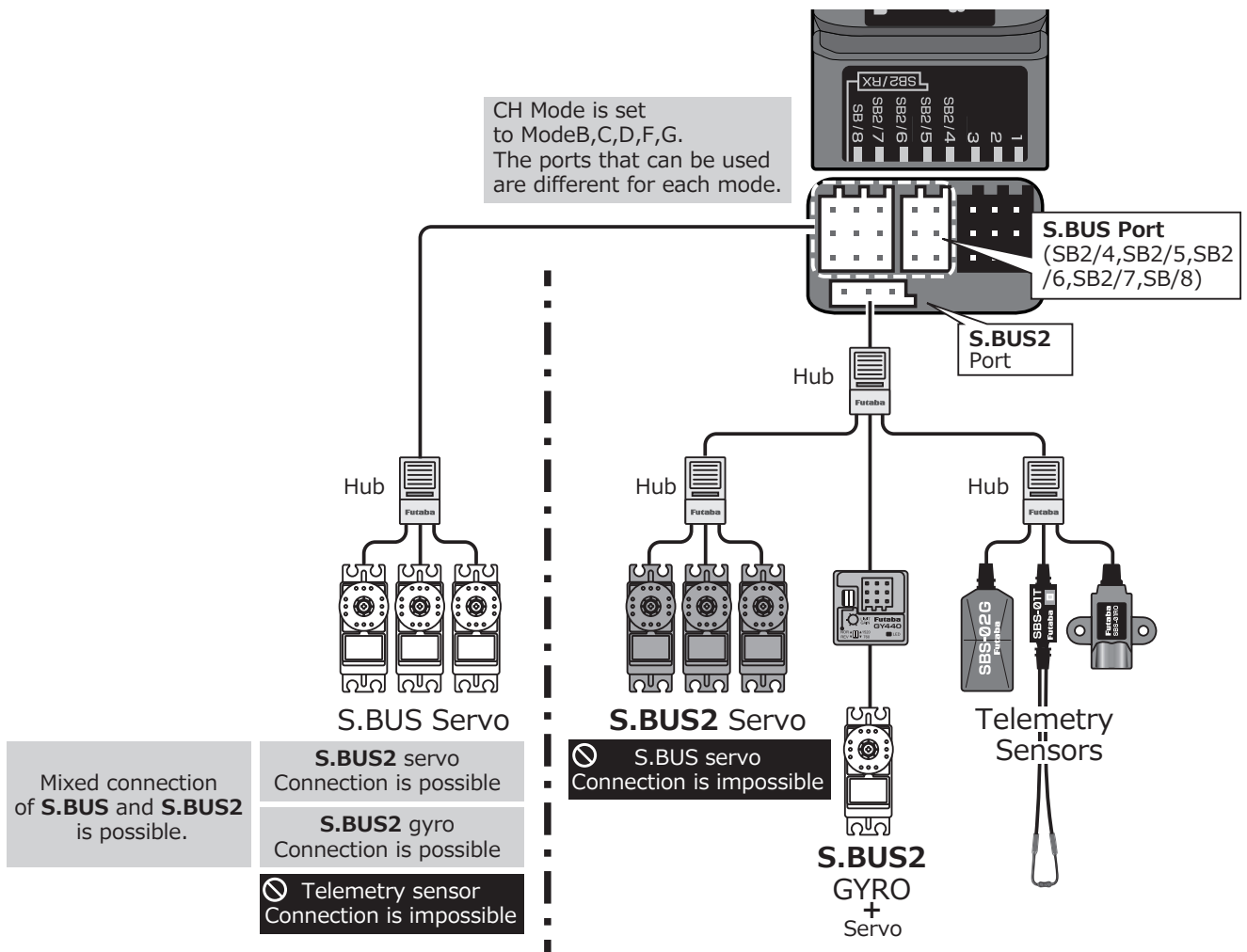

S.BUS/S.BUS2 device setting

S.BUS/S.BUS2 servos or a telemetry sensor can be connected directly to the T16IZ SUPER. Channel setting and other data can be entered for the S.BUS/S.BUS2 servos or sensors.

1. Connect the S.BUS device as shown in the figure.
2. Turn on the transmitter power.
3. Call the setup screen.
Servo: System Menu → S.BUS servo
Sensor: Linkage Menu → Sensor
4. Perform setting in accordance with each screen.
5. This sets the channel and other data for each S.BUS servo, or telemetry device to be used with the S.BUS device or receiver.

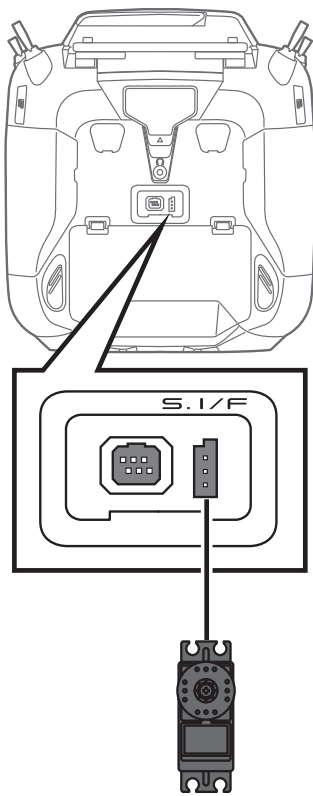

S.BUS/S.BUS2
device
(S.BUS/S.BUS2 servo)

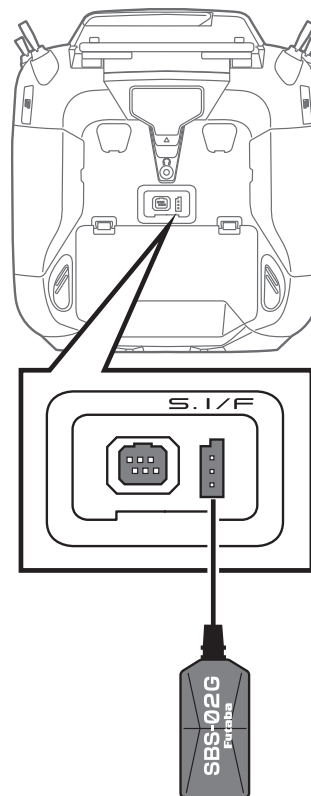

S.BUS/S.BUS2
device
(Telemetry sensor)

WARNING

 Do not disconnect or turn transmitter power OFF while S.BUS servo and telemetry sensor data is being saved.

- S.BUS servo and sensor save data will be lost, resulting in malfunction.

Home Screen

This is the Home screen and descriptions of its menus. Use your finger to operate the touch screen.

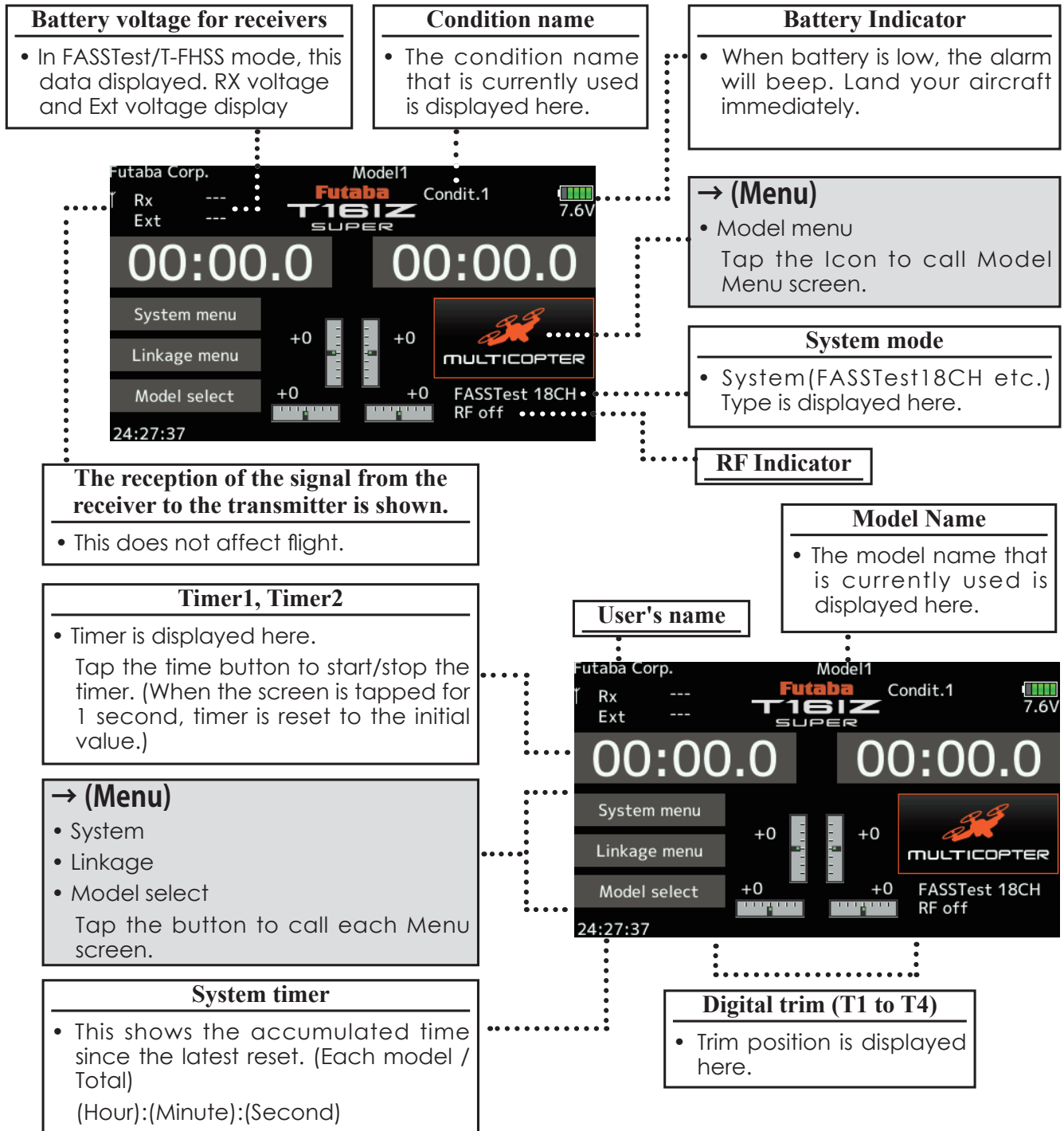

⚠ WARNING

❗ Be sure to confirm the model name before flying your aircraft.

❗ Check the battery voltage as often as possible and try to charge the battery earlier. If the battery alarm makes a sound, land your aircraft immediately.

*You can adjust the LCD contrast by the display setting in the system menu.

Link Procedure (T16IZ SUPER/R7208SB or R7308SB)

Each transmitter has an individually assigned, unique ID code. In order to start operation, the receiver must be linked with the ID code of the transmitter to which it is being paired. Once the link is made, the ID code is stored in the receiver and no further linking is necessary unless the receiver is to be used with another transmitter. When you purchase additional R7208SB or R7308SB receivers, this procedure is necessary; otherwise the receiver will not work.

Link procedure

1. Place the transmitter and the receiver close to each other within half (0.5m) meter.

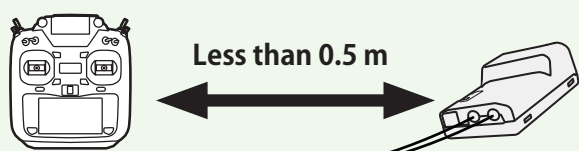

2. Turn on the transmitter.
3. Select [System type] at the Linkage menu and access the setup screen shown below by tapping the screen.

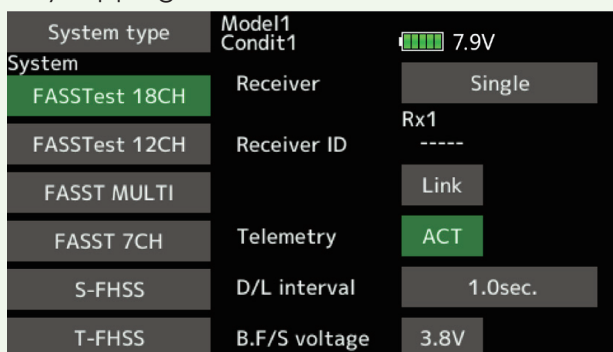

4. When you use two receivers on one model, you must change from [Single] to [Dual].

*Only two receivers can be used. In "Dual", two setting items come out. Input, respectively.

ID of a primary receiver displays.

ID of a secondary receiver displays.

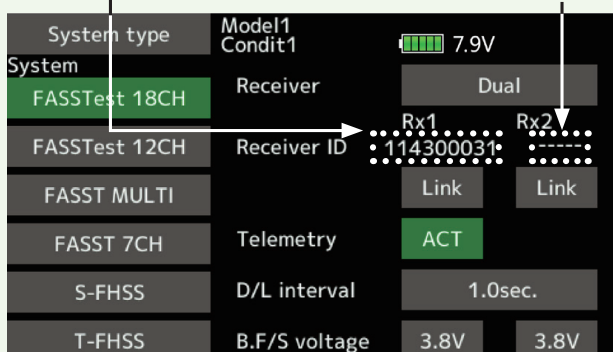

In Dual, a primary receiver (Rx1) is linked first. Next, a secondary (Rx2) receiver is linked.

5. Battery fail-safe voltage can be changed from the initial value of 3.8V here.

* Only in FASSTest/T-FHSS Mode.

6. [Link] is tapped. The transmitter will emit a chime as it starts the linking process.

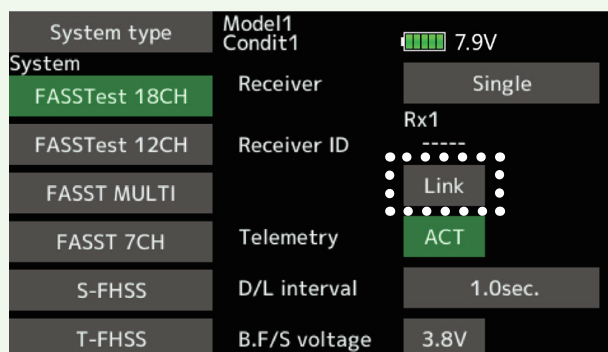

7. When the transmitter starts to chime, power on the receiver. The receiver should link to the transmitter within about 1 second.



In "Link" Mode



8. If linking fails, an error message is displayed. Bring the transmitter closer to the receiver and repeat the procedure above from Step 2.

9. ACT will be chosen if telemetry is used.
It is INH when not using it.

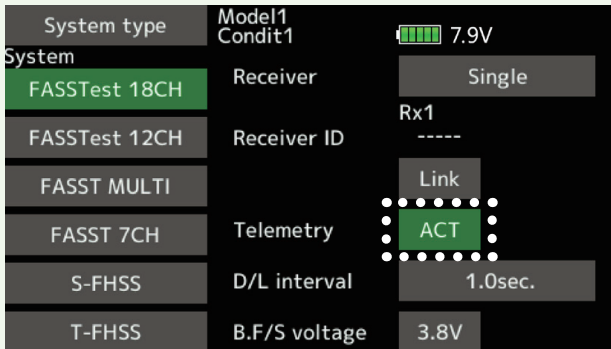

10. When a telemetry function is enabled, the receiving interval (down-link interval) of sensor data can be changed. If a D/L interval is increased, the response of the sensor data display becomes slower, but stick response will improve.
Initial value: 1.0s
Adjustment range: 0.1s~2.0s

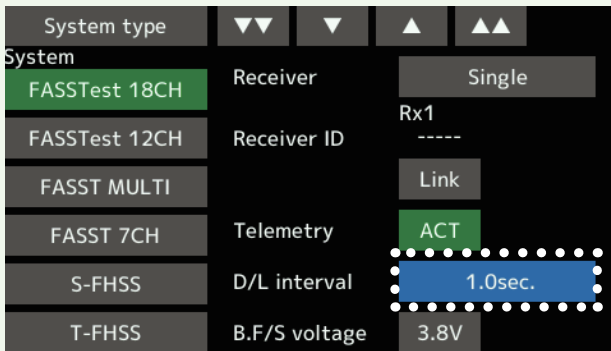

*If there are many FASSTest (T-FHSS) systems turned on around your receiver, it might not link to your transmitter. In this case, even if the receiver's LED stays solid green, unfortunately the receiver might have established a link to one of other transmitters. This is very dangerous if you do not notice this situation. In order to avoid the problem, we strongly recommend you to double check whether your receiver is really under control by your transmitter by giving the stick input and then checking the servo response.

*Do not perform the linking operation when the drive motor is connected or the engine is running.

*When you use two receivers, please be sure to setup a "Rx1" and "Rx2" in the "dual" mode.

*Telemetry function cannot be used for the 2nd receiver. → FASSTest18CH

*Telemetry function cannot be used for the dual receiver. → T-FHSS, FASSTest12CH

*You must link one receiver at a time. If both power supplies to the receivers are switched on simultaneously, data is received incorrectly by the transmitter.

*You cannot link three receivers.

*Link is required when a system type is changed.

*Linking is required whenever a new model is made.

*FASST MULTI/FASST 7CH cannot be selected for Europe.

⚠ WARNING

! After the linking is done, please cycle receiver power and check that the receiver to be linked is really under the control of the transmitter.

⊘ Do not perform the linking procedure with motor's main wire connected or with the engine operating as it may result in serious injury.

After setting

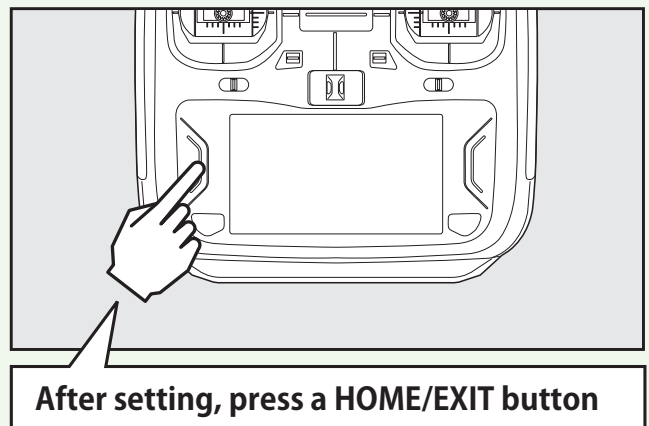

Model ID

FASSTest, T-FHSS

For the sake of safety, this function does not operate the receiver if the model data of the model program settings that does not match the aircraft is used by mistake.

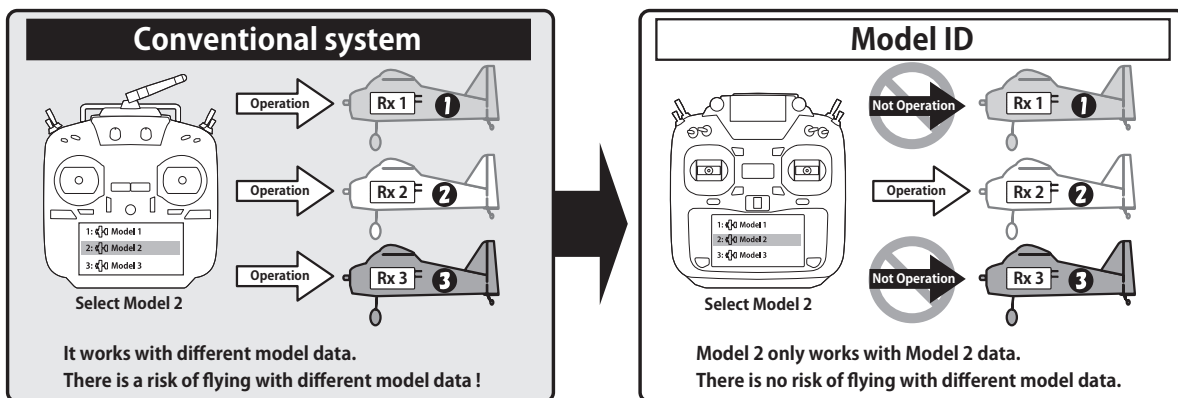

Link is required when a new model is made from a model selection.

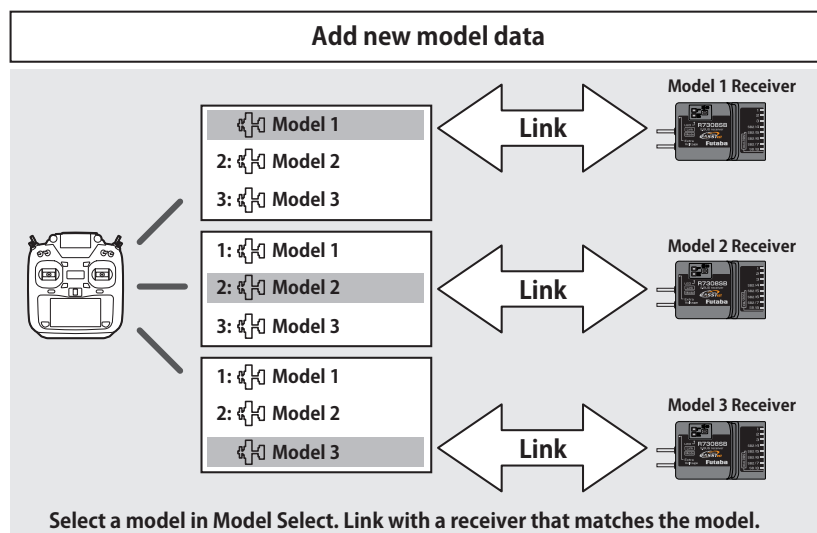

- In the system types (FASSTest, T-FHSS) compatible with the model ID function, a unique ID number (model ID) is set to each model data. Linking with a receiver stores the model ID of the model data in that receiver. The receiver operates only when it receives radio waves transmitted using model data that matches the stored model ID. As a result, the receiver does not operate even if model data of an unintended setting is used by mistake, so it is possible to prevent a malfunction due to a model selection mistake.
- If you want to use different model data from the model data that you have been using, link again.
- Model ID feature is enabled only if the system type is FASSTest or T-FHSS. Please note that model ID function can not be used on other systems.
- For safety reasons, model ID function can not be disabled.
- Model data that can be stored in internal memory is up to 30 models.
- Model ID is automatically set when copying or adding model data.
- R3004SB receiver does not support model ID function. When using the R3004SB, set "Receiver" in the system type screen T-FHSS mode setting to [R3004SB]. When using other T-FHSS compatible receivers, set "Receiver" to [Normal].

Range Testing Your R/C System

It is extremely important to range check your models prior to each flying session. This enables you to ensure that everything is functioning as it should and to obtain maximum enjoyment from your time flying. The T16IZ SUPER transmitter incorporates a system that reduces its power output and allows you to perform such a range check.

Range check mode

1. While pushing "U.MENU/MON." button.

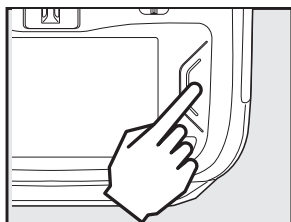

2. THR Stick Slow.

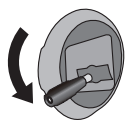

3. T16IZ SUPER Power ON.

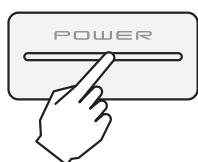

4. Select "Range check" at the System menu.

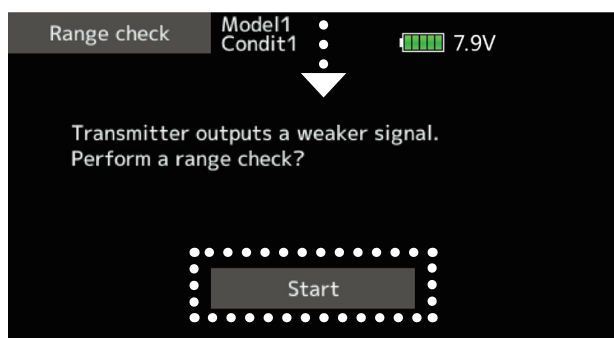
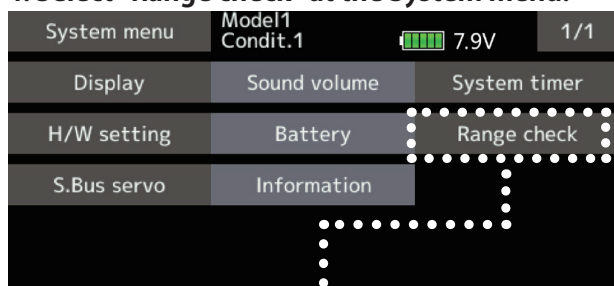

5. "Start" tap.



6. The HOME/EXIT button is pressed to end a range check.

During this mode, the RF power output is reduced so the range test can be performed. In addition, when this mode is activated the right LED on the front of the transmitter starts blinking and the transmitter gives users a warning with a beeping sound.

The "Range check mode" continues for 60 seconds and after that the power will return to the normal level. To exit the "Range check mode" before the 60 seconds, press the "HOME/EXIT" button. NEVER start flying when the "Range check mode" is active.

Should you require additional time to perform a range check, highlight Restart before your time expires and tap the screen one time.

Range check procedure

1. With the "Range check mode" on, walk away from the model while simultaneously operating the controls. Have an assistant stand by the model to confirm that all controls are completely and correctly operational. You should be able to walk approximately 30-50 paces from the model without losing control.
2. If everything operates correctly, return to the model. Set the transmitter in a safe, yet accessible, location so it will be within reach after starting the engine or motor. Be certain the throttle stick is in the low throttle position, then start the engine or motor. Perform another range check with your assistant holding the aircraft with the engine running at various speeds. If the servos jitter or move inadvertently, there may be a problem. We would strongly suggest you do not fly until the source of the difficulty has been determined. Look for loose servo connections or binding pushrods. Also, be certain that the battery has been fully charged.

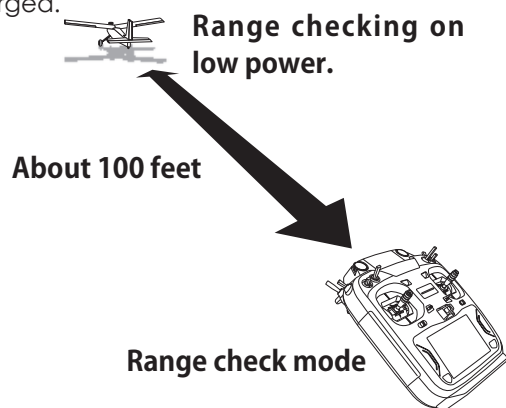

WARNING

Do not fly in the range check mode.

*Since the range of the radio waves is short, if the model is too far from the transmitter, control will be lost and the model will crash.

MODEL BASIC SETTING PROCEDURE

Airplane basic setting procedure

1. Model addition and call

Initial setting assigns 1 model to the T16IZ SUPER transmitter. The Model Select function is used to add models and to select models which are already set.

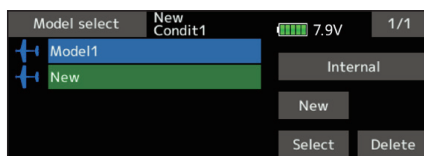

The data for up to 30 models can be saved to the transmitter. Data can also be saved to the optional microSD card.

The currently selected model name is displayed at the top of the screen. Before flying and before changing any settings, always confirm the model name.

2. Model type selection

Select the model type matched to the aircraft with the Model type select function of the Linkage menu. For an airplane, select the model type from among the 2 types: airplane and glider. After the wing type is selected the tail type select screen is displayed. Select the tail type matched to the aircraft.

There are 13 wing types and 3 tail types for airplane and glider.

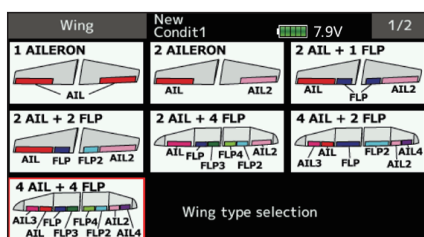

3. Fuselage linkage

Connect the ailerons, elevators, throttle, rudder, etc. in accordance with the model's instruction manual. For a description of the connection method, see the "Servos connection by model type".

Note: The channel assignment of the T16IZ SUPER is different from that of our existing systems. Note that even for the same "airplane model", when the wing type and tail type are different, the channel assignment may be different. (The channel assigned to each function can be checked at the "Function" of the Linkage menu.)

Ch	Function	Control	Trim
1	Aileron	J1	T1
2	Elevator	J3	T3
3	Throttle	J2	T2
4	Rudder	J4	T4
5	Gear	SG	--
6	Aileron2	--	--

- If the direction of the servo is incorrect, adjust the direction with the Reverse function of the Linkage menu.

Ch	Function	Normal	Reverse
1	Aileron	Normal	Reverse
2	Elevator	Normal	Reverse
3	Throttle	Reverse	Normal
4	Rudder	Normal	Reverse
5	Gear	Normal	Reverse
6	Aileron2	Normal	Reverse

- Adjust the neutral position and control surface angle with the linkage, and fine tune them with the Sub trim and End point functions (angle adjustment). To protect the linkage, a limit position can also be set with the End point function. The End point function can adjust the amount of up/down and left/right movement, limit, and servo speed of each channel.

Ch	Function	Sub-trim	Ch	Function	Sub-trim
1	Aileron	+0	7	Aileron2	+0
2	Elevator	+0	8	Aileron4	+0
3	Throttle	+0	9	Flap	+0
4	Rudder	+0	10	Flap2	+0
5	Gear	+0	11	Flap3	+0
6	Aileron2	+0	12	Flap4	+0

Ch	Function	Limit	Travel	Travel	Limit
1	Aileron	135	100	100	135
2	Elevator	135	100	100	135
3	Throttle	135	100	100	135
4	Rudder	135	100	100	135
5	Gear	135	100	100	135

4. Throttle cut setting

Throttle cut can be performed with one touch by a switch without changing the throttle trim position.

Set throttle cut with the Throttle cut function of the Linkage menu. After activating the throttle cut function and selecting the switch, adjust the throttle position so that the carburetor becomes fully closed. For safety, the throttle cut function operates the throttle stick in the 1/3 or less (slow side) position.

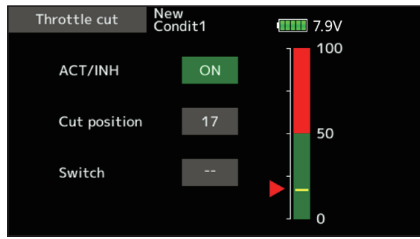

5. Idle down setting

The idling speed can be lowered with one touch by a switch without changing the throttle trim position. Perform this setting with the Idle down function of the Linkage menu. After activating the Idle down function and selecting the switch, adjust the idle down speed. For safety, the idle down function acts only when the throttle stick is slow side.

*While the Throttle cut function is in operation, the Idle down function does not work.

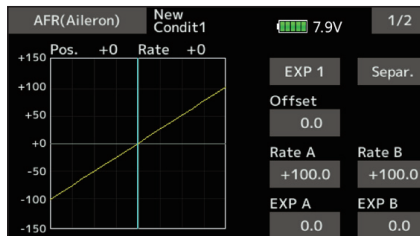

6. AFR (D/R)

AFR function is used to adjust the throw and operation curve of the stick, lever, and switch functions for each flight condition. This is normally used after End point has defined the maximum throw directions.

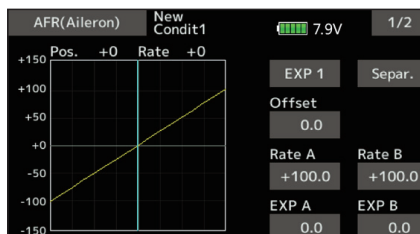

7. Airbrake

This function is used when an air brake is necessary when taking off or diving, etc.

The preset elevators and flaps (camber flap, brake flap) offset amount can be activated by a switch.

The offset amount of the aileron, elevator, and flap servos can be adjusted as needed. Also the speed of the aileron, elevator, and flap servos can be adjusted. (In side/Out side) A delay can be set for each condition, and a cut switch which will turn OFF the delay can be chosen. Trim amounts can be fine-tuned by setting a VR. You can also set the auto mode, which will link Airbrake to a stick, switch, or dial. A separate stick switch or dial can also be set as the ON/OFF switch.



8. Addition of flight conditions

The Condition select function automatically allocates the Condition 1 for each model. Condition 1 is the default condition and is the only one active when a new model type is defined.

If you want to add flight conditions, please refer to a description of the Condition select function.

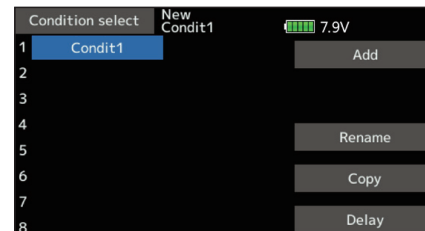

*The Condition 1 is always on, and remains on until other conditions are activated by switches.

*When a new condition is added, the model data of the Condition 1 is automatically copied to the new condition.

*You can set the model data of new condition in the switch ON state. However, if the group mode (Gr) was selected in advance, the same data will be input at all the conditions. Select the single mode (Sngl) and adjust only the condition you want to change. For Group/Single mode switching, refer to the description at the back of this manual.

*The Condition delay can be programmed for each channel. The Condition delay is used to change the servo throw smoothly when switching conditions.

Helicopter basic setting procedure

This section outlines examples of use of the helicopter functions of the T16IZ SUPER. Adjust the actual values, etc. to match the fuselage used.

1. Model addition and call

Default setting assigns 1 model to the T16IZ SUPER. To add new models or to call a model already set, use the Model select function.

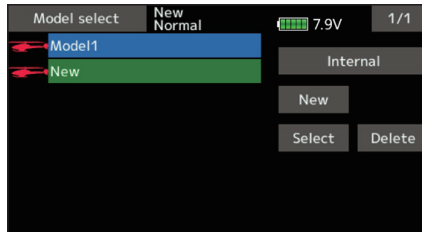

This is convenient when calling a model after registering the model names in advance. (The data of up to 30 models can be saved at the transmitter. Data can also be saved to the optional microSD card.)

The currently called model is displayed at the top of the screen. Before flying and before changing any settings, always confirm the model name.

2. Model type and swash type selection

If a different model type is already selected, select helicopter with the Model type function of the Linkage menu, and then select the swash type matched to the helicopter.

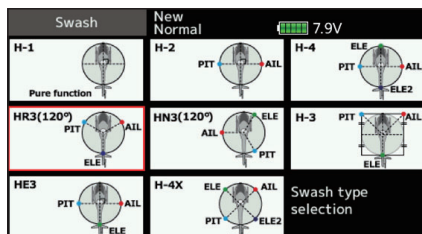

*The Model type function automatically selects the appropriate output channels, control functions, and mixing functions for the chosen model type. Eight swash types are available for helicopters.

*For a description of the swash type selection, refer to the Model type function.

3. Flight condition addition

The transmitter can install up to eight flight conditions per model.

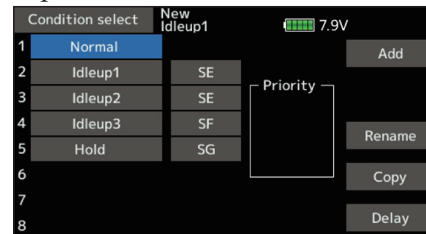

The Condition select function automatically allocates five conditions for helicopter.

(General setting)

- Normal
- Idle up1
- Idle up2
- Idle up3
- Hold

Note: Delete conditions you have not set up and will not use. Otherwise you may accidentally activate them during flight and cause a crash.

*For a description of the condition deletion, refer to the Condition select function.

The Normal condition is always on, and remains on until other conditions are activated by switches.

The priority is throttle hold/idle up 2/idle up 1/normal. Throttle hold has the highest priority. Add other conditions, as required.

The Condition delay can be programmed for each channel. The Condition delay is used to change the servo throw smoothly when switching conditions.

(General flight condition setting example)

- Normal: (Use initial setting conditions/operate when switch OFF)
Use from engine starting to hovering.
- Idle up 1: (Operate at SW-E center)
Use in 540° stall turn, loop, rolling stall turn, and other maneuvers.
- Idle up 2: (Operate at SW-E forward side)
Use in rolls.
- Throttle hold: (Operate at SW-G forward side)
Use in auto rotation.

4. Fuselage linkage

Connect the throttle rudder, aileron, elevator, pitch, and other servos in accordance with the kit instruction manual. For a description of the connection method, see "Servos connection by model type".

Note: The channel assignment of the T16IZ SUPER is different from that of our existing systems. (The channel assigned to each function can be checked at the Function menu of the Linkage menu.)

Ch	Function	New Condit1	Control	Trim
1	Aileron	J1	Gr.	T1
2	Elevator	J3	Gr.	T3
3	Throttle	J2	Gr.	T2
4	Rudder	J4	Gr.	T4
5	Gyro	--	Gr.	--
6	Pitch	J2	Gr.	--

- If the direction of operation of the servo is incorrect, use the Reverse function of the Linkage menu. Also use the swash AFR function in other than the H-1 mode.

Servo reverse	New Condit1	Ch	Function
1 Aileron	Normal	7	Governor
2 Elevator	Normal	8	Governor2
3 Throttle	Reverse	9	Gyro2
4 Rudder	Normal	10	Gyro3
5 Gyro	Normal	11	Needle
6 Pitch	Normal	12	Auxiliary5

Swash	New Condit1	Swash AFR
100	Neutral point	Aileron +50
50	Enter	Elevator +50
0		Pitch +50

- Adjust the direction of operation of the gyro. (Gyro side function)
- Connect the throttle linkage so that the carburetor can fully close at full trim throttle cut.
- Adjust the neutral position at the linkage side and fine tune with the Sub-Trim function and End point function (rudder angle adjustment). To protect the linkage, a limit position can also be set with the End point function.

Sub-trim	New Condit1	Ch	Function
1 Aileron	+0	7	Aileron2
2 Elevator	+0	8	Aileron4
3 Throttle	+0	9	Flap
4 Rudder	+0	10	Flap2
5 Gear	+0	11	Flap3
6 Aileron2	+0	12	Flap4

End point	New Condit1	Travel	Travel	Limit
1 Aileron	135	100	100	135
2 Elevator	135	100	100	135
3 Throttle	135	100	100	135
4 Rudder	135	100	100	135
5 Gear	135	100	100	135
6 Aileron2	135	100	100	135

- Swash plate correction (Except H-1 mode)
*If any interactions are noticed, for a description of the linkage correction function, please refer to the SWASH function.

5. Throttle/Pitch curve setting

This function adjusts the throttle or pitch operation curve in relation to the movement of the throttle stick for each condition.

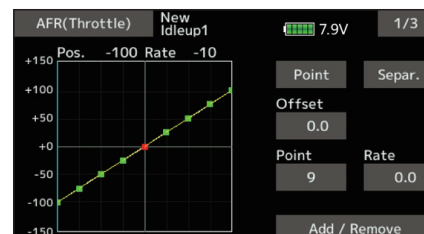

<Throttle curve setting example>

Call the throttle curve of each condition with the condition select switch.

- Normal curve adjustment
Normal curve creates a basic throttle curve centered near hovering. This curve is adjusted together with the pitch curve (Normal) so that the engine speed is constant and up/down control is easiest.
- Idle up curve adjustment
The low side Throttle curve creates a curve matched for aerobatics (loop, roll, 3D, etc.).
- Throttle hold curve adjustment
The curve is not used when performing auto rotation dives.
Confirm that the rate of the slowest position (0%) of the stick is 0% (initial setting).

<Example of pitch curve setting>

Call the pitch curve of each condition with the condition select switch.

- Pitch curve (Normal)
Make the pitch at hovering approximately +5°~6°. Set the pitch at hovering with the stick position at the 50% point as the standard.
*Stability at hovering may be connected to the throttle curve. Adjustment is easy by using the hovering throttle function and hovering pitch function together.
- Pitch curve (Idle up 1)
The idle up 1 pitch curve function creates a curve matched to airborne flight. Set to -7°~+12° as standard.

- Pitch curve (Idle up 2)
The high side pitch setting is less than idle up 1.
The standard is +8°.
- Pitch curve (Hold)
At auto rotation, use the maximum pitch at both the high and low sides.
[Pitch angle setting example]
Throttle hold: -7°~+12°

6. AFR (D/R)

AFR (D/R) function is used to adjust the throw and operation curve of aileron, elevator and rudder for each condition.

*For throttle and pitch curve settings, refer to the above-mentioned "Throttle/Pitch curve setting"

This is normally used after End point has defined the maximum throw directions.

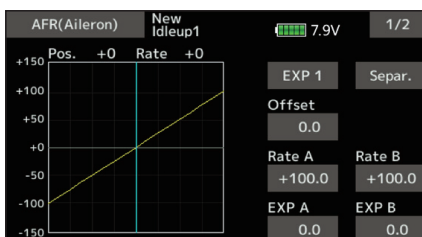

Dual rate	Status	Function	Switch
1 D/R 1	ON	Aileron	SD
2 D/R 2	INH	Elevator	SA
3 D/R 3	INH	Rudder	SB
4 D/R 4	INH	Aileron	--
5 D/R 5	INH	Aileron	--
6 D/R 6	INH	Aileron	--

7. Gyro sensitivity and mode switching

The gyro sensitivity and mode switching function is dedicated gyro mixing of the Model menu, and can be set for each condition.

Gyro	New Idleup1 7.9V					
	Gyro(RUD)	Gyro2(AIL)	Gyro3(ELE)			
Rate 1	AVCS	50	AVCS	50	AVCS	50
	ON	50	ON	50	ON	50
Rate 2	AVCS	50	AVCS	50	AVCS	50
	INH	50	INH	50	INH	50
Rate 3	AVCS	50	AVCS	50	AVCS	50
	INH	50	INH	50	INH	50

- Normal condition (hovering): Gyro sensitivity maximum
- Idle up 1/Idle up 2/Throttle hold: Gyro sensitivity minimum
- However, at auto rotation of a tail-driven helicopter, this function may not have any effect at high gyro sensitivity.

8. Throttle hold setting

*If throttle hold is necessary, please refer to the Throttle hold function.

9. Throttle cut setting

Throttle cut provides an easy way to stop the engine, by flipping a switch with the throttle stick at idle. The action is not functional at high throttle to avoid accidental dead sticks. The switch's location and direction must be chosen, as it defaults to INH.

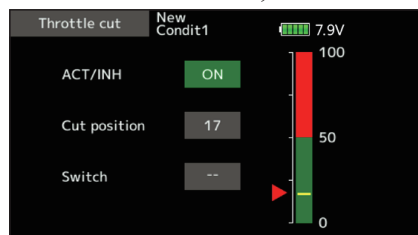

*With throttle stick at idle, adjust the cut position until the engine consistently shuts off, but throttle linkage is not binding.

10. Swash Mix corrects aileron, elevator and pitch interaction

The swash mixing function is used to correct the swash plate in the aileron (Left/Right Cyclic) and elevator (Forward/Aft Cyclic) direction corresponding to each operation of each condition.

Mixing	Status	Switch	Trim
Aileron → Elevator	INH	--	OFF
Elevator → Aileron	INH	--	OFF
Pitch → Aileron	INH	--	
Pitch → Elevator	INH	--	

11. Throttle mixing setting

*If throttle mixing is necessary to compensate for engine slowing caused when the swash plate operates at the same time as ailerons or elevator, please refer to the Throttle mixing function.

12. Other special mixings

- Pitch to Needle mixing
This mixing is used with engines that allow needle control during flight (fuel-air mixture adjustment). A needle curve can be set. The needle servo rise characteristics at throttle stick acceleration/ deceleration operation can be adjusted. (Acceleration function)
- Governor mixing
This mixing is dedicated governor mixing when a governor is used. Up to 3 rates (speeds) can be switched for each condition.

Servo Connection by Model Type

The T16IZ SUPER transmitter channels are automatically assigned for optimal combination according to the type selected with the Model type function of the Linkage menu. The channel assignment (initial setting) for each model type is shown below. Connect the receiver and servos to match the type used.

*The set channels can be checked at the Function screen of the Linkage menu. The channel assignments can also be changed. For more information, read the description of the Function menu.

Airplane/glider

•Normal tail and V tail

RX CH	1AIL		2AIL		2AIL+1FLAP		2AIL+2FLAP		2AIL+4FLAP		4AIL+2FLAP		4AIL+4FLAP		The output CH of each system
	Airplane	Glider	Airplane	Glider	Airplane	Glider	Airplane	Glider	Airplane	Glider	Airplane	Glider	Airplane	Glider	
1	Aileron	Aileron	Aileron	Aileron	Aileron	Aileron	Aileron	Aileron	Aileron	Aileron	Aileron	Aileron	Aileron	Aileron	FASTest 18CH FASTest 12CH FASTest 7CH FASTest 5-FHSS FASTest 1-FHSS
2	Elevator	Elevator	Elevator	Elevator	Elevator	Elevator	Elevator	Elevator	Elevator	Elevator	Elevator	Elevator	Elevator	Elevator	
3	Throttle	Motor	Throttle	Motor	Throttle	Motor	Throttle	Motor	Throttle	Rudder	Throttle	Rudder	Throttle	Rudder	
4	Rudder	Rudder	Rudder	Rudder	Rudder	Rudder	Rudder	Rudder	Rudder	Aileron2	Rudder	Aileron2	Rudder	Aileron2	
5	Gear	AUX6	Gear	AUX6	Gear	AUX6	Aileron2	Aileron2	Gear	Flap	Gear	Aileron3	Gear	Aileron3	
6	Airbrake	Airbrake	Aileron2	Aileron2	Aileron2	Aileron2	Flap	Flap	Aileron2	Flap2	Aileron2	Aileron4	Aileron2	Aileron4	
7	AUX5	AUX5	AUX5	AUX5	Flap	Flap	Flap2	Flap2	Flap	Flap3	Aileron3	Flap	Aileron3	Flap	
8	AUX4	AUX4	AUX4	AUX4	AUX5	AUX5	Gear	AUX6	Flap2	Flap4	Aileron4	Flap2	Aileron4	Flap2	
9	AUX3	AUX3	AUX3	AUX3	AUX4	AUX4	AUX5	AUX5	Flap3	Motor	Flap	Motor	Flap	Flap3	
10	AUX2	AUX2	AUX2	AUX2	AUX3	AUX3	AUX4	AUX4	Flap4	AUX6	Flap2	AUX6	Flap2	Flap4	
11	AUX1	AUX1	AUX1	AUX1	AUX2	AUX2	AUX3	AUX3	AUX5	AUX5	AUX5	AUX5	Flap3	Motor	
12	AUX1	AUX1	AUX1	AUX1	AUX1	AUX1	AUX2	AUX2	AUX4	AUX4	AUX4	AUX4	Flap4	AUX6	
13	AUX1	AUX1	AUX1	AUX1	AUX1	AUX1	AUX1	AUX1	AUX3	AUX3	AUX3	AUX3	AUX5	AUX5	
14	AUX1	AUX1	AUX1	AUX1	AUX1	AUX1	AUX1	AUX1	AUX2	AUX2	AUX2	AUX2	AUX4	AUX4	
15	AUX1	AUX1	AUX1	Butterfly	AUX1	Butterfly	AUX1	Butterfly	AUX1	Butterfly	AUX1	Butterfly	AUX3	Butterfly	
16	AUX1	AUX1	Camber	Camber	Camber	Camber	Camber	Camber	Camber	Camber	Camber	Camber	Camber	Camber	
DG1	SW	SW	SW	SW	SW	SW	SW	SW	SW	SW	SW	SW	SW	SW	
DG2	SW	SW	SW	SW	SW	SW	SW	SW	SW	SW	SW	SW	SW	SW	

*FASTest MULTI/FASTest 7CH cannot be selected for Europe.

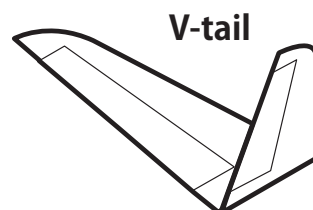

Airplane/glider

•Ailevator

RX CH	1AIL		2AIL		2AIL+1FLAP		2AIL+2FLAP		2AIL+4FLAP		4AIL+2FLAP		4AIL+4FLAP		The output CH of each system
	Airplane	Glider	Airplane	Glider	Airplane	Glider	Airplane	Glider	Airplane	Glider	Airplane	Glider	Airplane	Glider	
1	Aileron	Aileron	Aileron	Aileron	Aileron	Aileron	Aileron	Aileron	Aileron	Aileron	Aileron	Aileron	Aileron	Aileron	FASSTest 18CH FASSTest 12CH S-FHSS FASST 7CH FASSTest 18CH FASST MULTI T-FHSS
2	Elevator	Elevator	Elevator	Elevator	Elevator	Elevator	Elevator	Elevator	Elevator	Elevator	Elevator	Elevator	Elevator	Elevator	
3	Throttle	Motor	Throttle	Motor	Throttle	Motor	Throttle	Motor	Throttle	Motor	Throttle	Motor	Throttle	Motor	
4	Rudder	Rudder	Rudder	Rudder	Rudder	Rudder	Rudder	Rudder	Rudder	Rudder	Rudder	Rudder	Rudder	Rudder	
5	Gear	AUX6	Gear	AUX6	Elevator2	Elevator2	Elevator2	Elevator2	Elevator2	Elevator2	Elevator2	Elevator2	Elevator2	Elevator2	
6	Airbrake	Airbrake	Aileron2	Aileron2	Aileron2	Aileron2	Aileron2	Aileron2	Aileron2	Aileron2	Aileron2	Aileron2	Aileron2	Aileron2	
7	Elevator2	Elevator2	Elevator2	Elevator2	Flap	Flap	Flap	Flap	Flap	Flap	Aileron3	Aileron3	Aileron3	Aileron3	
8	AUX5	AUX5	AUX5	AUX5	Gear	AUX6	Flap2	Flap2	Flap2	Flap2	Aileron4	Aileron4	Aileron4	Aileron4	
9	AUX4	AUX4	AUX4	AUX4	AUX5	AUX5	Gear	AUX6	Flap3	Flap3	Flap	Flap	Flap	Flap	
10	AUX3	AUX3	AUX3	AUX3	AUX4	AUX4	AUX5	AUX5	Flap4	Flap4	Flap2	Flap2	Flap2	Flap2	
11	AUX2	AUX2	AUX2	AUX2	AUX3	AUX3	AUX4	AUX4	Gear	AUX6	Gear	AUX6	Flap3	Flap3	
12	AUX1	AUX1	AUX1	AUX1	AUX2	AUX2	AUX3	AUX3	AUX5	AUX5	AUX5	AUX5	Flap4	Flap4	
13	AUX1	AUX1	AUX1	AUX1	AUX1	AUX1	AUX2	AUX2	AUX4	AUX4	AUX4	AUX4	Gear	AUX6	
14	AUX1	AUX1	AUX1	AUX1	AUX1	AUX1	AUX1	AUX1	AUX3	AUX3	AUX3	AUX3	AUX5	AUX5	
15	AUX1	AUX1	AUX1	Butterfly	AUX1	Butterfly	AUX1	Butterfly	AUX2	Butterfly	AUX2	Butterfly	AUX4	Butterfly	
16	AUX1	AUX1	Camber	Camber	Camber	Camber	Camber	Camber	Camber	Camber	Camber	Camber	Camber	Camber	
DG1	SW	SW	SW	SW	SW	SW	SW	SW	SW	SW	SW	SW	SW	SW	
DG2	SW	SW	SW	SW	SW	SW	SW	SW	SW	SW	SW	SW	SW	SW	

*FASST MULTI/FASST 7CH cannot be selected for Europe.

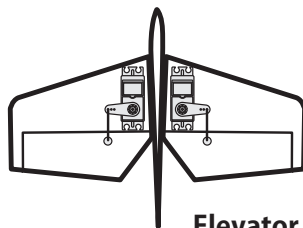

Elevator 2 servos

Airplane/glider

•Tailless wing

RX CH	2AIL		2AIL+1FLAP		2AIL+2FLAP		2AIL+4FLAP		4AIL+2FLAP		4AIL+4FLAP	
	Airplane	Glider	Airplane	Glider	Airplane	Glider	Airplane	Glider	Airplane	Glider	Airplane	Glider
1	Aileron	Aileron	Aileron	Aileron	Aileron	Aileron	Aileron	Aileron	Aileron	Aileron	Aileron	Aileron
2	AUX4	AUX4	AUX4	AUX4	AUX4	AUX4	Aileron2	Aileron2	Aileron2	Aileron2	Aileron2	Aileron2
3	Throttle	Motor	Throttle	Motor	Throttle	Motor	Throttle	Motor	Throttle	Motor	Throttle	Motor
4	Rudder	Rudder	Rudder	Rudder	Rudder	Rudder	Rudder	Rudder	Rudder	Rudder	Rudder	Rudder
5	Gear	AUX6	Gear	AUX6	Aileron2	Aileron2	Flap	Flap	Aileron3	Aileron3	Aileron3	Aileron3
6	Aileron2	Aileron2	Aileron2	Aileron2	Flap	Flap	Flap2	Flap2	Aileron4	Aileron4	Aileron4	Aileron4
7	AUX5	AUX5	Flap	Flap	Flap2	Flap2	Flap3	Flap3	Flap	Flap	Flap	Flap
8	AUX3	AUX3	AUX5	AUX5	Gear	AUX6	Flap4	Flap4	Flap2	Flap2	Flap2	Flap2
9	AUX2	AUX2	AUX3	AUX3	AUX5	AUX5	AUX4	AUX4	AUX4	AUX4	Flap3	Flap3
10	AUX1	AUX1	AUX2	AUX2	AUX3	AUX3	Gear	AUX6	Gear	AUX6	Flap4	Flap4
11	AUX1	AUX1	AUX1	AUX1	AUX2	AUX2	AUX5	AUX5	AUX5	AUX5	AUX4	AUX4
12	AUX1	AUX1	AUX1	AUX1	AUX1	AUX1	AUX3	AUX3	AUX3	AUX3	Gear	AUX6
13	AUX1	AUX1	AUX1	AUX1	AUX1	AUX1	AUX2	AUX2	AUX2	AUX2	AUX5	AUX5
14	AUX1	AUX1	AUX1	Butterfly	AUX1	Butterfly	AUX1	Butterfly	AUX1	Butterfly	AUX3	Butterfly
15	Camber	Camber	Camber	Camber	Camber	Camber	Camber	Camber	Camber	Camber	Camber	Camber
16	Elevator	Elevator	Elevator	Elevator	Elevator	Elevator	Elevator	Elevator	Elevator	Elevator	Elevator	Elevator
DG1	SW	SW	SW	SW	SW	SW	SW	SW	SW	SW	SW	SW
DG2	SW	SW	SW	SW	SW	SW	SW	SW	SW	SW	SW	SW

The output CH of each system

FASSTest 18CH
FASSTest 12CH
S-FHSS
FASST 7CH

FASSTest 18CH
FASST MULTI
T-FHSS

*FASST MULTI/FASST 7CH cannot be selected for Europe.

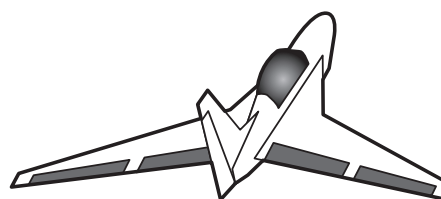

Flying Wing

Airplane/glider

•Tailless wing Winglet 2 Rudder

RX CH	2AIL		2AIL+1FLAP		2AIL+2FLAP		2AIL+4FLAP		4AIL+2FLAP		4AIL+4FLAP	
	Airplane	Glider	Airplane	Glider	Airplane	Glider	Airplane	Glider	Airplane	Glider	Airplane	Glider
1	Aileron	Aileron	Aileron	Aileron	Aileron	Aileron	Aileron	Aileron	Aileron	Aileron	Aileron	Aileron
2	Rudder2	Rudder2	Rudder2	Rudder2	Rudder2	Rudder2	Aileron2	Aileron2	Aileron2	Aileron2	Aileron2	Aileron2
3	Throttle	Motor	Throttle	Motor	Throttle	Motor	Throttle	Motor	Throttle	Motor	Throttle	Motor
4	Rudder	Rudder	Rudder	Rudder	Rudder	Rudder	Rudder	Rudder	Rudder	Rudder	Rudder	Rudder
5	Gear	AUX6	Gear	AUX6	Aileron2	Aileron2	Flap	Flap	Aileron3	Aileron3	Aileron3	Aileron3
6	Aileron2	Aileron2	Aileron2	Aileron2	Flap	Flap	Flap2	Flap2	Aileron4	Aileron4	Aileron4	Aileron4
7	AUX5	AUX5	Flap	Flap	Flap2	Flap2	Flap3	Flap3	Flap	Flap	Flap	Flap
8	AUX3	AUX3	AUX5	AUX5	Gear	AUX6	Flap4	Flap4	Flap2	Flap2	Flap2	Flap2
9	AUX2	AUX2	AUX3	AUX3	AUX5	AUX5	Rudder2	Rudder2	Rudder2	Rudder2	Flap3	Flap3
10	AUX1	AUX1	AUX2	AUX2	AUX3	AUX3	Gear	AUX6	Gear	AUX6	Flap4	Flap4
11	AUX1	AUX1	AUX1	AUX1	AUX2	AUX2	AUX5	AUX5	AUX5	AUX5	Rudder2	Rudder2
12	AUX1	AUX1	AUX1	AUX1	AUX1	AUX1	AUX3	AUX3	AUX3	AUX3	Gear	AUX6
13	AUX1	AUX1	AUX1	AUX1	AUX1	AUX1	AUX2	AUX2	AUX2	AUX2	AUX5	AUX5
14	AUX1	AUX1	AUX1	Butterfly	AUX1	Butterfly	AUX1	Butterfly	AUX1	Butterfly	AUX3	Butterfly
15	Camber	Camber	Camber	Camber	Camber	Camber	Camber	Camber	Camber	Camber	Camber	Camber
16	Elevator	Elevator	Elevator	Elevator	Elevator	Elevator	Elevator	Elevator	Elevator	Elevator	Elevator	Elevator
DG1	SW	SW	SW	SW	SW	SW	SW	SW	SW	SW	SW	SW
DG2	SW	SW	SW	SW	SW	SW	SW	SW	SW	SW	SW	SW



*FASST MULTI/FASST 7CH cannot be selected for Europe.

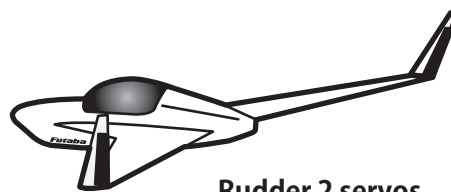

* Output channels differ by each system of a table. When using a system with few channels, there is a wing type which cannot be used. It cannot be used when there is a function required out of the range of the arrow of a figure.

Helicopter

● FASSTest 18CH / FASST MULTI / FASST 7CH / S-FHSS

CH	H-4/H-4X Swash	All other
1	Aileron	Aileron
2	Elevator	Elevator
3	Throttle	Throttle
4	Rudder	Rudder
5	Gyro	Gyro
6	Pitch	Pitch
7	Governor	Governor
8	Elevator2	Governor2
9	Gyro2	Gyro2
10	Gyro3	Gyro3
11	Governor2	Needle
12	Needle	AUX5
13		AUX4
14		AUX3
15		AUX2
16		AUX1
DG1		SW
DG2		SW

The output CH of each system
 S-FHSS FASSTest 18CH FASST MULTI T-FHSS FASST 7CH

● FASSTest 12CH

CH	H-4/H-4X Swash	All other
1	Aileron	Aileron
2	Elevator	Elevator
3	Throttle	Throttle
4	Elevator2	Rudder
5	Pitch	Pitch
6	Gyro	Gyro
7	Governor	Governor
8	Rudder	Governor2
9	Gyro2	Gyro2
10	Gyro3	Gyro3
DG1		SW
DG2		SW

The output CH of each system
 FASSTest 12CH

*FASST MULTI/FASST 7CH cannot be selected for Europe.

Multicopter

CH	Multicopter
1	Aileron
2	Elevator
3	Throttle
4	Rudder
5	Gyro
6	Gyro2
7	Gyro3
8	Camera TILT
9	Camera PAN
10	Camera REC
11	Mode
12	AUX5
13	AUX4
14	AUX3
15	AUX2
16	AUX1
DG1	SW SD
DG2	SW SA

The output CH of each system
 S-FHSS FASSTest 18CH FASST MULTI T-FHSS FASSTest 12CH FASST 7CH











*FASST MULTI/FASST 7CH cannot be selected for Europe.

SYSTEM MENU

The System menu sets up functions of the transmitter. This does not set up any model data.

- When the System menu button is tapped, the menu shown below is called up. Tap the function button that you want to enter.

System menu functions table

 Display	Display adjustment.
 Sound volume	Adjust the volume of: Other sound, Warning, Voice
 System timer	Resets the system timer.
 H/W setting	Stick mode selection (Mode 1 - Mode 4). J1-J4 sticks correction can be performed.
 Battery	Battery alarm voltage setting. Auto power off time setting.
 Range check	The output of the transmitter is lowered, for Range checking.
 S.Bus servo	S.BUS servo setting.
 Servo update	Update the S.BUS servo.
 Sensor update	Update the corresponding telemetry sensor.
 Information	Sets the User name, Language, and Unit system. Displays the program version, and microSD card information.

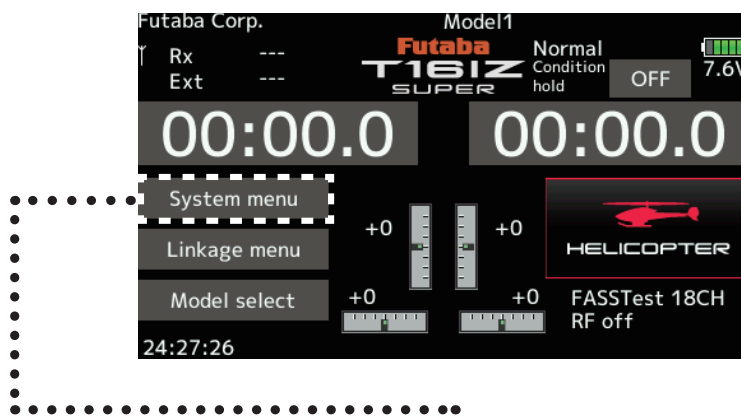

- Return to Home screen

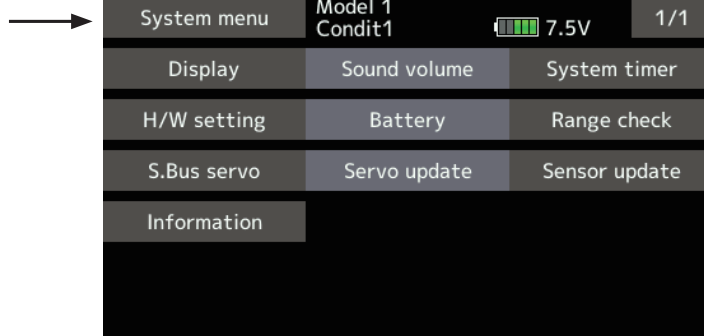

Display

The following LCD screen adjustments:

- Backlighting brightness adjustment
- Backlighting decrease time adjustment
- Touch screen calibration

- Tap the [Display] button in the System menu to call the setup screen shown below.

- Return to System menu

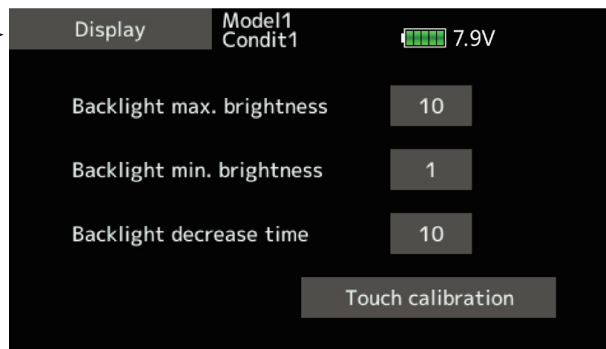

Backlight max. brightness adjustment

1. Adjust the backlighting brightness with the value input buttons.

*When the ▲ button is tapped, the backlighting becomes brighter. When the ▼ button is tapped, the backlighting becomes darker.

Backlight min. brightness adjustment

1. Adjust the backlight decrease brightness with the value input buttons.

*When the ▲ button is tapped, the backlighting becomes brighter. When the ▼ button is tapped, the backlighting becomes darker.

*It cannot be made brighter than Backlighting brightness adjustment.

Backlight decrease time

1. You can set a time period to decrease the LCD backlight. This function counts the period that the Touch Panel has been not operated. This time can be set by ten-second steps. You can also turn off the backlight decrease* if you like.

*The backlight consumes a large amount of power. We recommend that you turn off the backlight by setting the backlight power-off time to about one minute.

Touch calibration

This function adjusts the location of the Touch Panel. Press the "Touch calibration" button. The calibration screen will then pop up. Tap the center of the cross hair cursor on the screen with the soft pen. As soon as the system recognizes the position, the cursor will move on to the next position. Repeat this procedure as long as the cursor moves to next position. You will do this five times. Calibration will be carried out based on the five positions. Disappearance of the cross hair cursor means the calibration has been completed.

*In ordinary operation, this calibration is not necessary. If you notice the Touch Panel is not functioning correctly after long use, we recommend that you carry out this calibration.

Sound volume

Sound volume setting

This function can set the volume of "Other sound," "Warning," and "Voice," respectively.

- Tap the [Sound volume] button in the System menu to call the setup screen shown below.
- Return to System menu

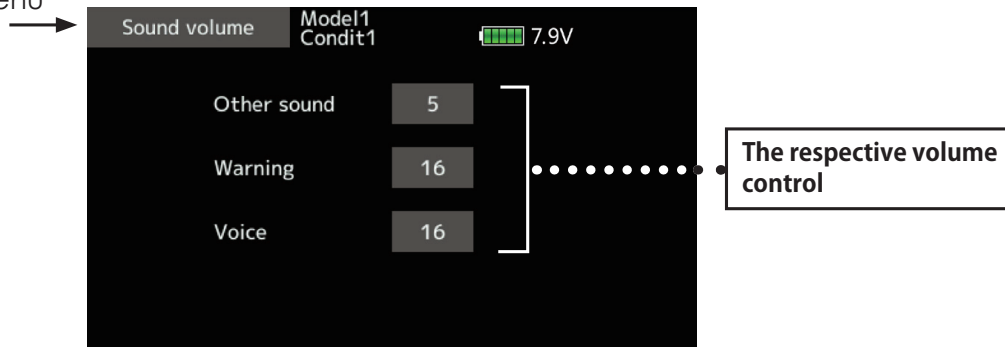

Sound volume Setting method

1. When the Sound volume box is tapped, the above screen will appear.

2. You can change the sound volume by tapping the "▲▲" "▲" "▼▼" "▼" button of four items.

*If you tap "▲", the volume will increase. If you tap the "▼", the volume will decrease.

System timer

Integrating timer resetting

This function adjusts the system timer of the T16IZ SUPER transmitter. The system timer can also be reset.

*The system timer is displayed on the Home screen.

- Tap the [System timer] button in the System menu to call the setup screen shown below.
- Return to System menu

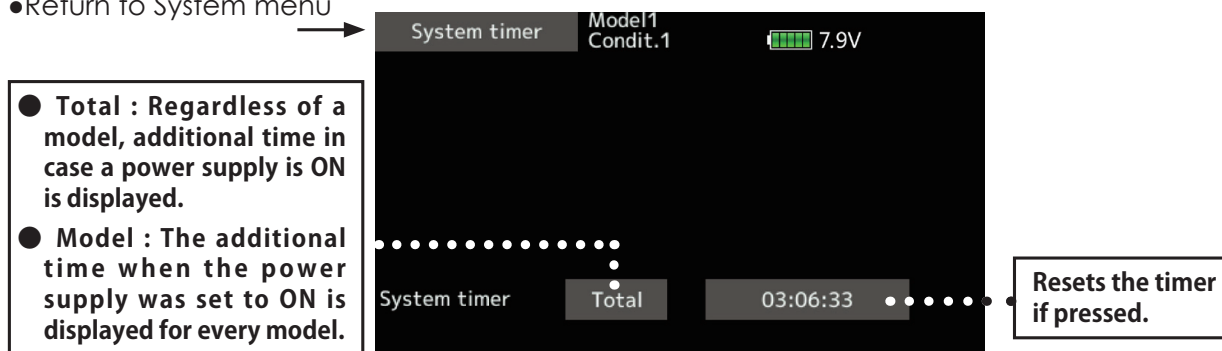

System timer reset

The system timer shows the total time that has elapsed since the last "reset".

1. Tap "Total" or "Model" to choose reset.
2. Tap the [System timer] button.
3. Tap "Yes" in the next screen to reset the timer.

H/W setting

Stick mode selection and J1-J4 sticks calibration

Usually, this H/W setting is unnecessary. Please perform this calibration only if a change at the center of a stick should arise after prolonged use.

- Tap the [Calibration] button in the System menu to call the setup screen shown below.

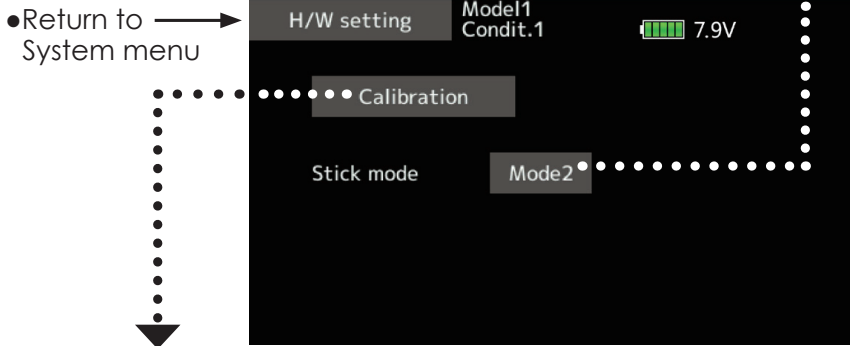

Stick mode

Mode 1-4 can be chosen. But, it isn't changed until data is reset.

To change the mode the stick ratchet must be changed. Request that this be done by Futaba Service. (Charged modification)

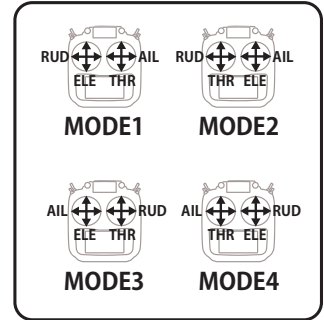

How to Calibrate

1. Tap the "Calibration" button.



2. Choose the stick to calibrate right and left.
3. The stick is set at neutral and the [Set neutral] button is tapped.

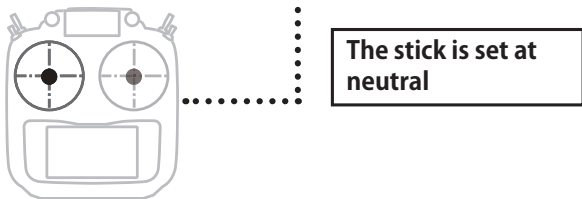
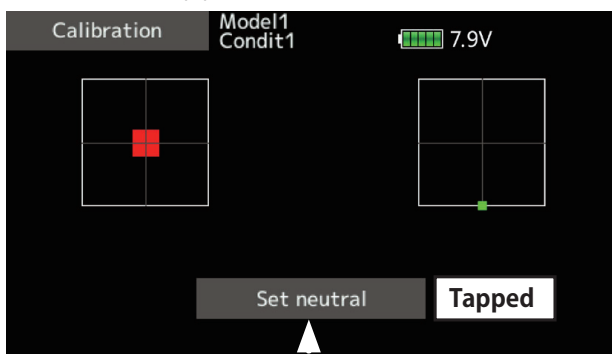

4. The stick is held at full right and full bottom (diagonal). The [Set endpoint] button is tapped.
5. The stick is held at full left and full top (diagonal). The [Set endpoint] button is tapped.

*Please do not press the stick too firmly in any direction when doing the calibration.

*Check after calibration to make sure that neutral is 0%, the bottom right side is +100%, and the top left side is -100%.

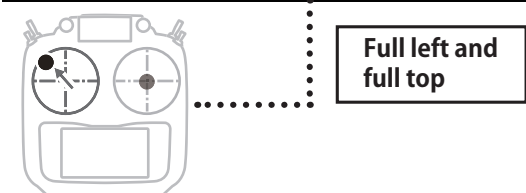
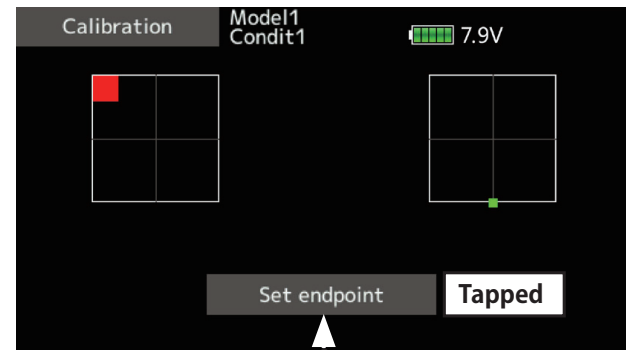
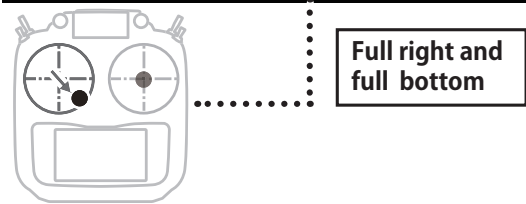
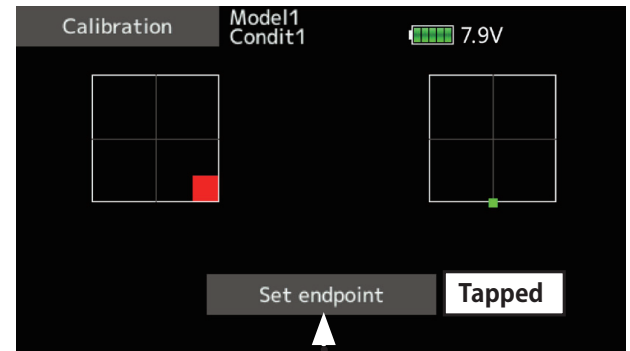

Battery

Low battery alarm voltage set

Select the battery alarm voltage according to the battery to be used.

- Return to System menu

It isn't indicated in case of manual setting.

Battery type change : LiPo(2cells) → Manual setting

When choosing manual setting, the numerical value can be input.

⚠ It's dangerous to set it manually in the low voltage.

Auto power off time setting

This function prevents battery discharging if the transmitter power supply does not erase.

1. Adjust the auto power off time with the value input buttons.

*When the time the transmitter is inactive reaches the set time, the power is turned off automatically. This time can be set up to 1 hour in 10 minutes increments. The auto power off function can also be deactivated.

*An audible alarm is sounded from 3 minutes before auto power off. When a stick or switch is operated, the alarm is cleared.

Vibrator Types

Type 1 →

Type 2 → →

Type 3 → → → →

*When the low battery voltage setting is changed, it is changed for every model in the transmitter. A unique voltage cannot be set for each model. A change in the low battery voltage setting also does not reset other data.

Range Check

Before a flight ground range check.

The 'range check mode' reduces the transmission range of the radio waves to allow for a ground range check.

*The range check mode, when activated, will continue for 60 seconds unless the user exits this mode early. When the progress bar reaches 60 second mark, the RF transmission automatically returns to the normal operating power.

⚠ WARNING

! Do not fly in the range check mode.

*Since the range of the radio waves is short, if the model is too far from the transmitter, control will be lost and the model will crash.



S.Bus servo

S.BUS servo setting

An S.BUS(2) servo can memorize the channel and various settings you input. Servo setting can be performed on the T16IZ SUPER screen by wiring the servo as shown in the figure.

- * With some S.BUS(2) servos, there are some functions which cannot be used. If a function cannot be used, the display screen will change. (Only the function which can be used by a servo is displayed.)
- * After reading completion, with connection of the above figure, if a stick is moved, servo operation can be tested.

- Call the following setting screen by pressing the [S.BUS Servo] button in the System menu.
- Return to System menu

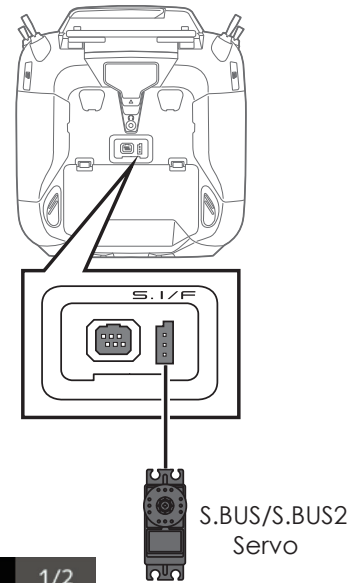

Procedure for changing S.BUS servo setting

1. Select [S.Bus servo] of the System menu.
2. Wire the servo as shown in the figure above.
3. Press [Read]. The ID and current setting of that servo are displayed.

4. When multiple servos are connected change [INH] at the right side of the ID number on the screen to [ACT] and enter the ID of the servo you want to set.
5. Set each item. (Please see the next page.)
6. Press [Write]. The settings are changed.

• Servo ID number

If you use multiple S.BUS servos, only the desired servo in the group can be set by entering the ID of that specific servo.

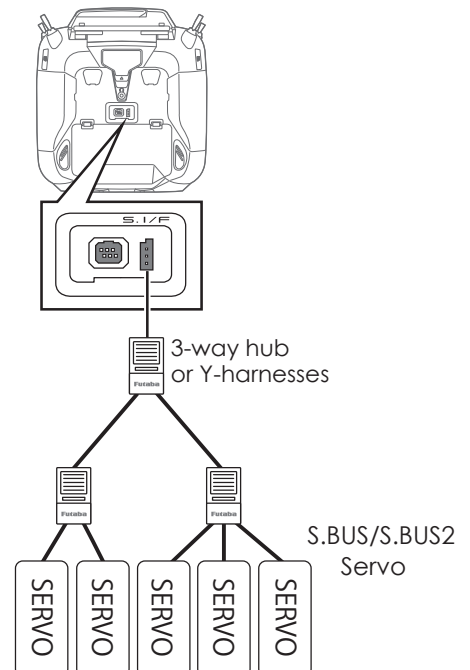

S.BUS Servo Description of each parameter's function

*There are functions that can and cannot be performed according to the servo type.

• ID

Displays the ID of the servo whose parameters are to be read. It cannot be changed.

• Channel

Channel of the S.BUS system assigned to the servo. Always assign a channel before use.

• Reverse

The direction in which the servo rotates can be changed.

• Soft Start

Restricts operation in the specified direction the instant the power is turned on. By using this setting, the first initial movement when the power is turned on slowly moves the servo to the specified position.

• Stop Mode

The state of the servo when the servo input signal is lost can be specified. The "Hold" mode setting holds the servo in its last commanded position even if using AM or FM system.

• Smoother

This function changes smoothness of the servo operation relative to stick movement changes. Smooth setting is used for normal flight. Select the "OFF" mode when quick operation is necessary such as 3D.

• Neutral Offset

The neutral position can be changed. When the neutral offset is large value, the servo's range of travel is restricted on one side.

• Speed Control

Speeds can be matched by specifying the operating speed. The speed of multiple servos can be matched without being affected by motor fluctuations. This is effective for load torques below the maximum torque.

However, note that the maximum speed will not exceed what the servo is capable of even if the servo's operating voltage is increased.

• Dead band

The dead band angle at stopping can be specified.

[Relationship between dead band set value and servo operation]

Small Value Setting → Dead band angle is small and the servo is immediately operated by a small signal change.

Large Value Setting → Dead band angle is large and the servo does not operate at small signal changes.

(Note) If the dead band angle is too small, the servo will operate continuously and the current consumption will increase and the life of the servo will be shortened.

• Travel Adjust

The left and right travels centered about the neutral position can be set independently.

• Boost

The minimum current applied to the internal motor when starting the servo can be set. Since a small travel does not start the motor, it essentially feels like the dead band was expanded. The motor can be immediately started by adjusting the minimum current which can start the motor.

[Relationship between boost set value and servo operation]

Small Value Setting → Motor reacts to a minute current and operation becomes smooth.

Large Value Setting → Initial response improves and output torque increases. However, if the torque is too large, operation will become rough.

• Boost ON/OFF

OFF : It is the boost ON at the time of low-speed operation.(In the case of usual)

ON : It is always the boost ON.(When quick operation is hope)

• Damper

The characteristic when the servo is stopped can be set.

When smaller than the standard value, the characteristic becomes an overshoot characteristic. If the value is larger than the standard value, the brake is applied before the stop position.

Especially, when a large load is applied, overshoot, etc. are suppressed by inertia and hunting may occur, depending on the conditions. If hunting (phenomena which cause the servo to oscillate) occurs even though the Dead Band, Stretcher, Boost and other parameters are suitable, adjust this parameter to a value larger than the initial value.

[Relationship between damper set value and servo operation]

Small Value Setting → When you want to overshoot. Set so that hunting does not occur.

Large Value Setting → When you want to operate so that braking is not applied. However, it will feel like the servo response has worsened.

(Note) If used in the hunting state, not only will the current consumption increase, but the life of the servo will also be shortened.

• Stretcher

The servo hold characteristic can be set. The torque which attempts to return the servo to the target position when the current servo position has deviated from the target position can be adjusted.

This is used when stopping hunting, etc., but the holding characteristic changes as shown below.

[Relationship between stretcher and servo operation]

Small Value Setting → Servo holding force becomes weaker.

Large Value Setting → Servo holding force becomes stronger.

(Note) When this parameter is large, the current consumption increases.

• Buzzer

When a servo is powered up without a transmitter signal, a buzzer sounds.

(When transmitter signal is lost, a buzzer sounds until the servo regains the signal. This is not unusual.)

The transmitter has been turned OFF ahead of a servo power supply → The buzzer sound of about 1.25 Hz continues sounding as servo power supply end failure alarm.

(Do not insert or remove the servo connector while the receiver power is ON. A buzzer may sound by incorrect recognition.)

* Buzzer sound is generated by vibrating the motor of a servo.

Since current is consumed and a servo generates heat, please do not operate the number more than needed or do not continue sounding a buzzer for a long time.

WARNING

 **While S.BUS servo writes, you aren't supposed to remove a connection of a servo and turn off a power supply of a transmitter.**

■ Data of S.BUS servo is damaged and breaks down.

Servo update

This function updates the corresponding Futaba S.BUS servos.

It is a function for updating the program of Futaba S.BUS2 servo from T16IZ SUPER.

To update the servo, you need a PC that can be connected to the Internet, a micro SD card (commercial product).

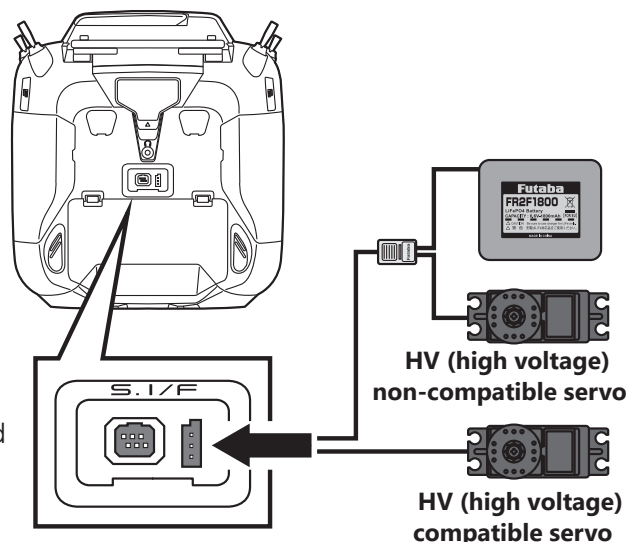

- Select [Servo update] at the linkage menu and call the setup screen shown below.

- Return to Linkage menu

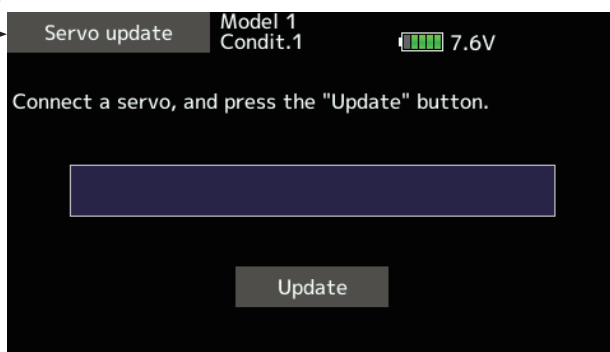

Preparing for update

- Download the zip file of the update data from our website or your local distributor's website.
- Extract the zip file on your computer. A folder named "FUTABA" is created.
- Insert the micro SD card that contains the "FUTABA" folder into the transmitter.

Update procedure

1. Connect the S.BUS/S.BUS2 servo to the transmitter as shown above.
2. Turn on the power of the transmitter and select [Servo update] in the system menu.
3. Tap [Update] to start the software update for that servo.
4. It is complete when [Update succeeded.] is displayed on the screen.

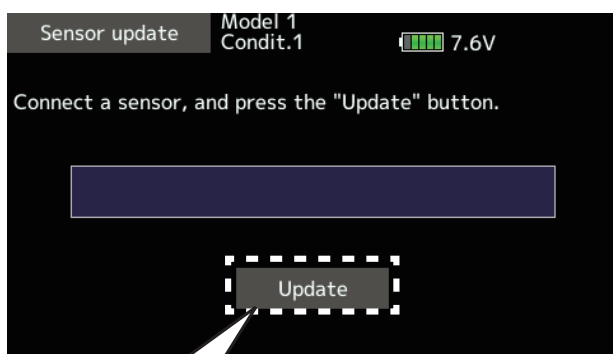

Tap the update button.

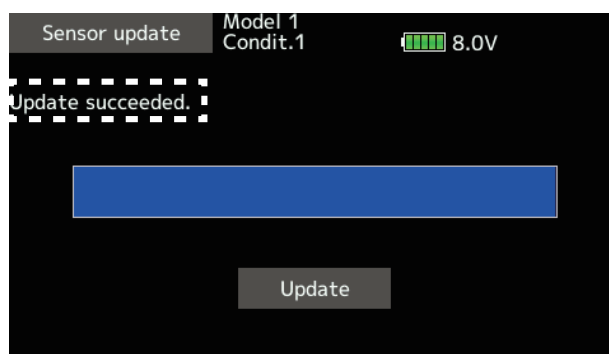

Sensor update

This function updates the corresponding Futaba telemetry sensors.

It is a function for updating the program of Futaba telemetry sensor from T16IZ SUPER.

To update the servo, you need a PC that can be connected to the Internet, a micro SD card (commercial product).

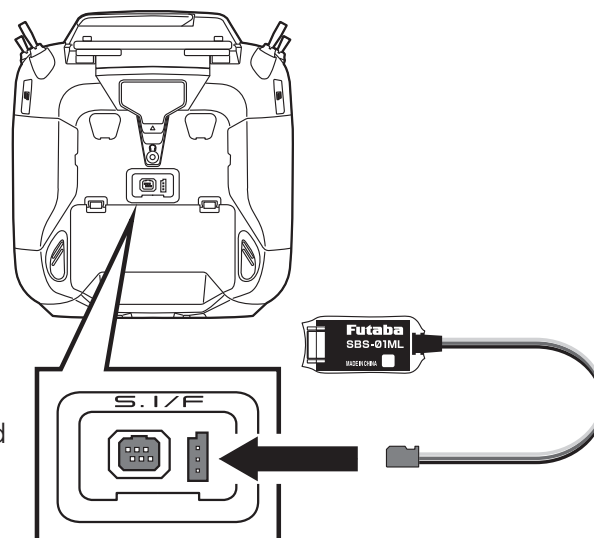

- Select [Sensor update] at the linkage menu and call the setup screen shown below.

- Return to Linkage menu

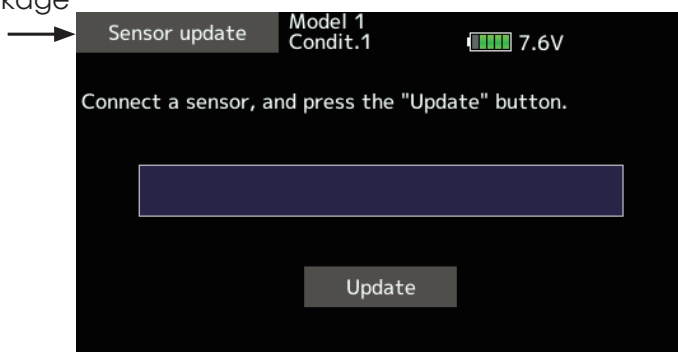

Preparing for update

- Download the zip file of the update data from our website or your local distributor's website.
- Extract the zip file on your computer. A folder named "FUTABA" is created.
- Insert the micro SD card that contains the "FUTABA" folder into the transmitter.

Update procedure

1. Connect the telemetry sensor to the transmitter as shown above.
2. Turn on the power of the transmitter and select [Sensor update] in the system menu.
3. Tap [Update] to start the software update for that telemetry sensor.
4. It is complete when [Update succeeded.] is displayed on the screen.

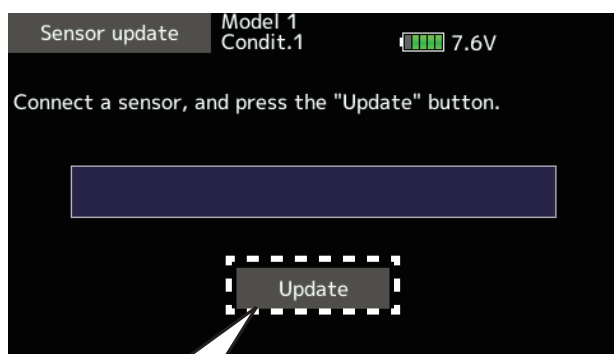

Tap the update button.

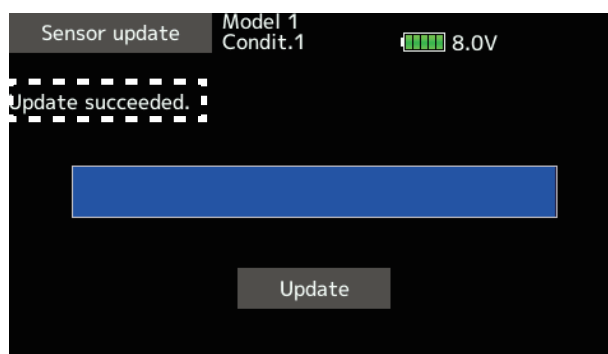

Information

The program version and microSD card size are displayed. The User name, language and Unit system used by the system can also be changed.

This function registers the T16IZ SUPER user name and the language displayed at proportional can be changed.

Telemetry numerical values can be displayed in either metric or SAE (yard-pound) units.

The Information screen displays the T16IZ SUPER system program version information, microSD card (memory size, card free size) information.

*If a microSD card is not inserted, no memory card information will be displayed.

- Tap the [Information] button at the System menu to call the setup screen shown below.
- Return to System menu

Telemetry Display Unit

[Metric]
 Distance --- m (meter)
 Speed --- km/h (kilometers per hour)
 Variometer --- m/s (meter per second)
 Temperature --- °C (centigrade)

[Yard]
 Distance --- yard
 Altitude --- feet
 Speed --- mph (mile per hour)
 Variometer --- fpm (ft per min)
 Temperature --- °F (fahrenheit)

Information Model1 Normal 7.9V 1/2

User name Futaba Corp

Language English

Unit system Metric

Version

Memory card size 122MB

Card free size 121MB

2/2 : WEB Manual QR code

Fix and return to an information screen.

Movement of a cursor of an input box

Back space (Input box)

Next page (Character list 2/4 - 4/4)

An input box is reset

Input box

Shift key

Shift key

User name Model 1 Condit.1 7.4V 1/3

Futaba Corp.

← → BS Undo

1	2	3	4	5	6	7	8	9	0
q	w	e	r	t	y	u	i	o	p
a	s	d	f	g	h	j	k	l	-
↑	z	x	c	v	b	n	m	^	↑
\	@	[;	:]	,	.	/	

Registration of the user's name

T16IZ SUPER transmitter can register user's name.

How to register user's name

1. Turn on the power of the transmitter.
2. Select "user's name" and then the keyboard will pop up.
3. You can use up to 15 characters as a user's name. Use the keyboard on the screen to enter user's name.

Language Model1 Condit.1 7.3V



















English	French
Japanese	Spanish
German	Czech
Dutch	Italian

The language displayed at proportional can be changed. The initial setting is English, but different languages can be selected.

LINKAGE MENU

The Linkage menu is made up of functions which perform model addition, model type selection, end point setting, and other model basic settings.

Linkage menu functions table

 Servo monitor	Displays the servo test and operation position
 Model select	Model addition, call, deletion, copy, model name setting
 Model type	Model type, wing type, tail type, swash type, selection
 Servo reverse	Servo direction reversal
 End point	Servo basic rate adjustment and limit setting
 Servo speed	Servo speed setting
 Sub-trim	Adjusts the neutral position of each servo
 Function	Channel assignment of each function can be changed
 Fail safe	Fail safe function and battery fail safe function setting
 System type	System mode selection, link of a transmitter and receiver, telemetry mode selection
 Trim setting	Control step amount and mode selection of the digital trim
 Throttle cut	Stops the engine safely and easily
 Idle down	Lowers the idle speed of the engine
 Swash ring	Limits the swash plate travel to within a fixed range. (helicopter only)
 Swash	Swash AFR and linkage correction function (helicopter only except swash type H-1)
 Stick alarm	Can be set so that an audible alarm sounds when the throttle stick reaches the set position.
 Timer	Timer setting
 Function name	Function name can be changed
 Sensor	Various telemetry sensors setting
 Telemetry	Displays various data sent from the receiver
 Tele.setting	Telemetry data log
 Trainer	Starts and sets the trainer system.
 Warning setting	Mixing, throttle position warning reset
 User menu setting	Original menu making
 Date reset	Model memory set data reset (by item)

- Tap the [Linkage menu] button in the Home screen to call the setup screen shown below.

- Select the function name and return to the Home screen.

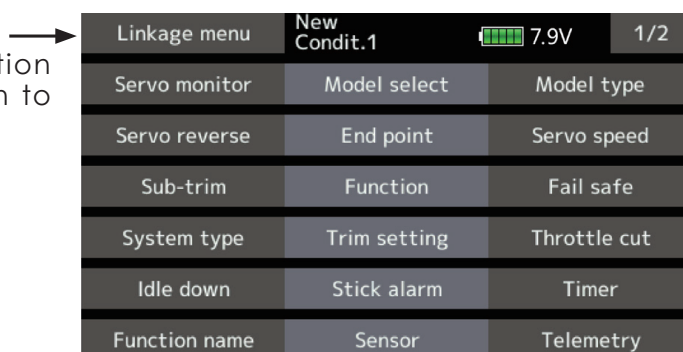

Servo monitor

Servo Test & Graph Display / Displays servo positions.

This is used for testing servo movement. “Moving Test” (repetition mode) and “Neutral Test” (fixed position mode) are available.

The “Neutral Test” is good for finding the neutral position of a servo horn.

In order to prevent any potential difficulties, the servo test function will be inoperable, or inaccessible, under certain conditions. Specifically, the Servo Test function is not operational if the Throttle cut is ON in either airplane or helicopter modes; or if the Throttle hold is ON in helicopter mode.

- Select [Servo monitor] at the linkage menu and call the setup screen shown below.

< or >

● Long press the [U.MENU/MON.] button in the Home screen to call the setup screen shown.

- Return to Home or Linkage menu

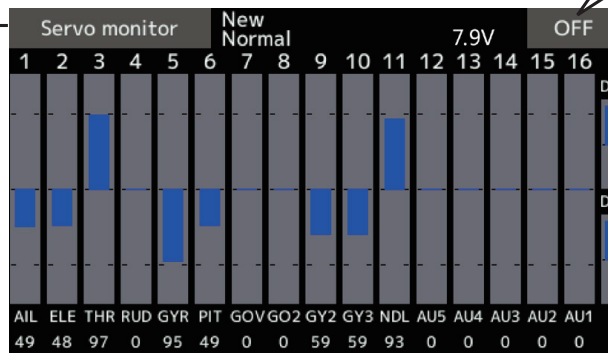

Each channel movement can be checked.

Failure ?

Yes

No

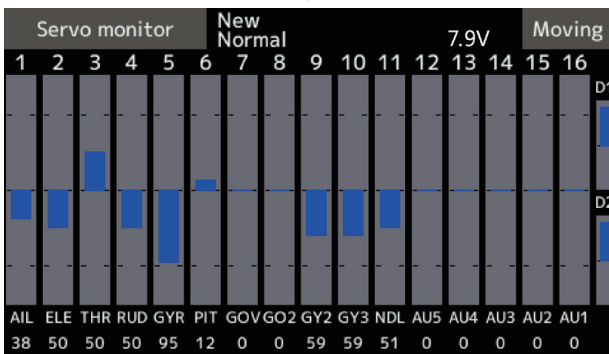

[Moving]: Mode which repeats operation of each servo

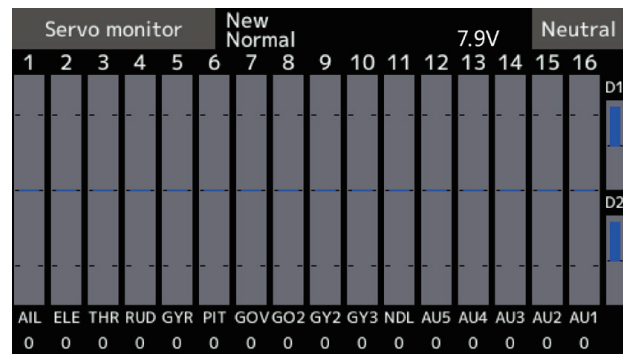

[Neutral]: Mode which locks each servo in the neutral position

Select the [OFF] or pushing the HOME/EXIT button → Testing is stopped

⚠ WARNING

❗ Don't set a servo test mode when the drive motor is connected and the engine has been started.

■ Inadvertent rotation of the motor or acceleration of the engine is extremely dangerous.

Model select

The Model selection function performs model addition, call, deletion, copy, and model name setting.

This function is used to load the settings of the desired model into the T16IZ SUPER's memory.

The settings may be selected from either the transmitter's built-in memory. Remember that up to 30 model memories are available in the transmitter. The model data of the microSD card is for storage. microSD card model data cannot be called directly from the transmitter. The name of the model stored in the transmitter and the microSD card may be changed. This can be very useful to tell different models settings apart. Each model name can be as

long as 15 characters, and the model name always appears in the display screen.

The Copy function is used to copy one set of model data into a second memory within the transmitter and the microSD card. It may be used for getting a head-start on setting up models with almost the same settings (only differences need to be modified, instead of entering the complete model from scratch). Also, this function may be used to make a backup copy of a model setup before any changes are made.

- Select [Model select] at the linkage menu and call the setup screen shown below.

< or >

- Tap the [Model select] button in the Home screen to call the setup screen shown below.

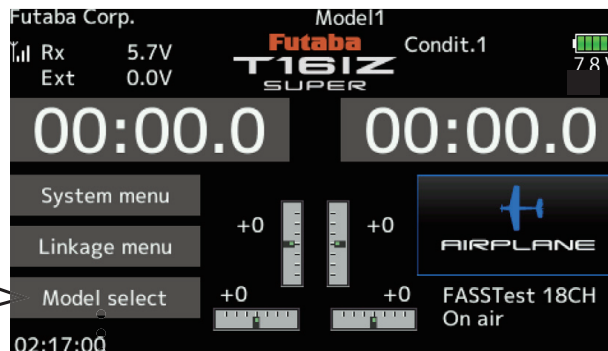

- Return to Home or Linkage menu

Current model is green.

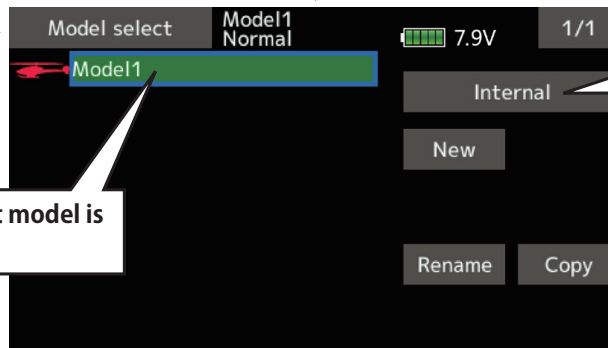

- "Save to"
[Internal]: transmitter memory
[SD card]: microSD card

Model addition

1. Tap the [New] button.

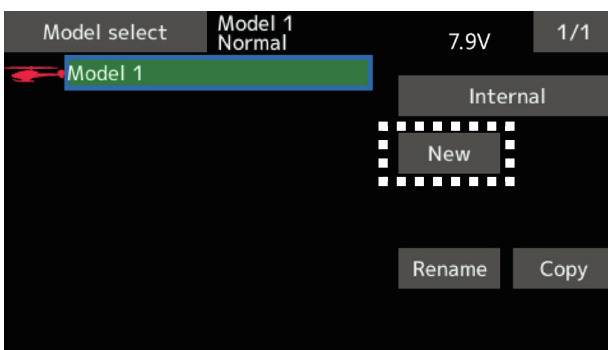

2. Tap [Yes] to add the model. (When you want to cancel model addition, tap [No].)

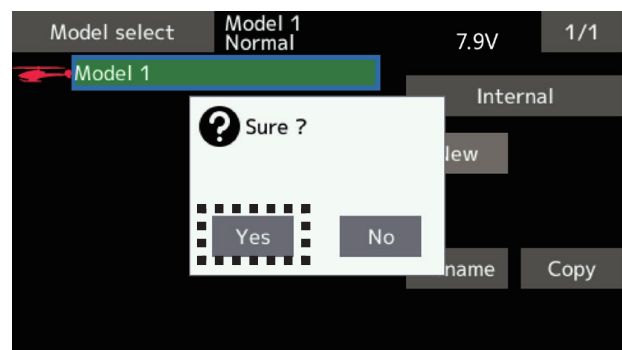

*The added model is displayed in the model list.

*When a model is added, a receiver link is required.

Model call

1. Tap the Internal or SD card. Select the location to which the desired model is to be saved.

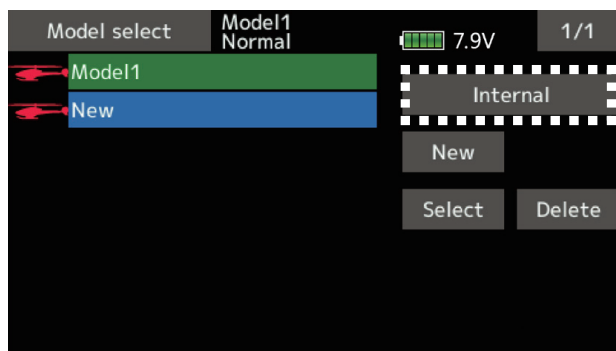

2. Tap the desired model in the model list.
3. Tap the [Select] button.

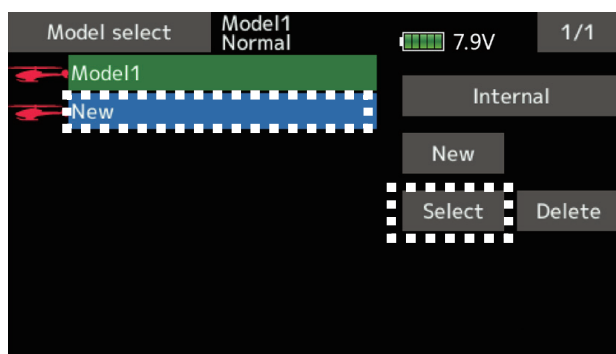

4. Tap [Yes] to call the model. (When you want to cancel model call, press [No].)

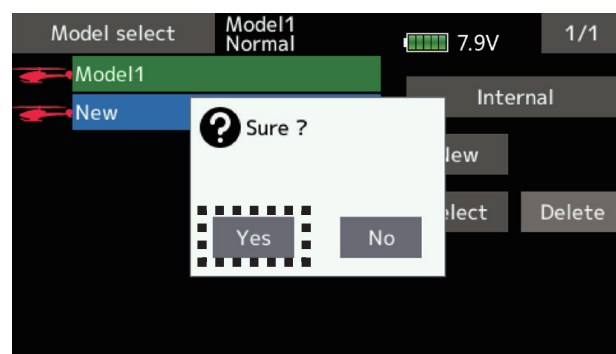

Model deletion

1. Tap the select model name or the model you want to delete in the model list.
(The model currently selected cannot be deleted.)

2. Tap the [Delete] button.

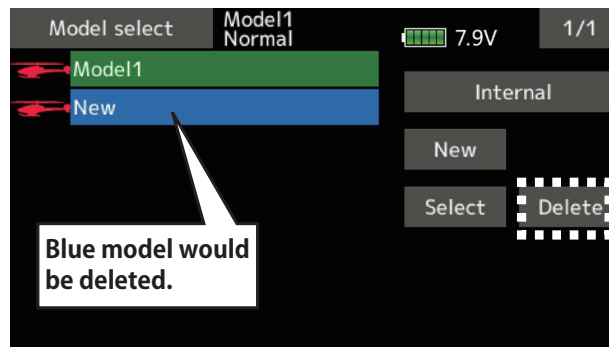

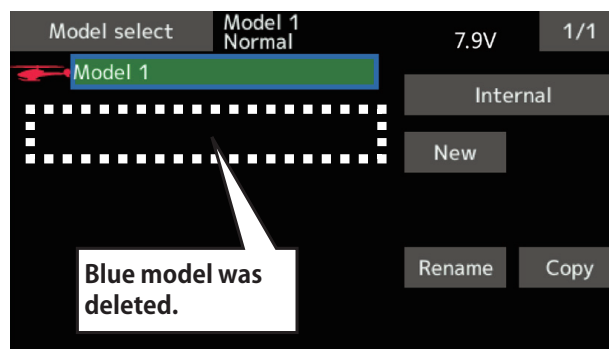
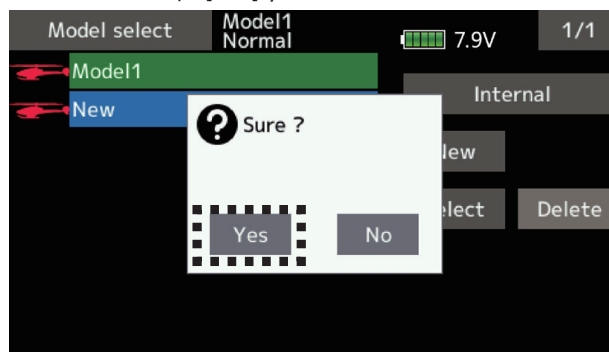

3. Tap [Yes]. (When you want to stop model deletion, tap [No].)



When using model data of T18SZ, T16SZ, FX-36, FX-32

1. The microSD card in which the model data of another transmitter is saved is displayed on the model select screen.

T18SZ →  FX-32 → 

2. Copy the model data of another transmitter to T16IZ SUPER. The data will be converted for T16IZ SUPER.
3. Select the converted model data.

*The model data converted for T16IZ SUPER cannot be used in another transmitter.

Model name change

1. The model data chosen at current model can be changed. The current model name, tap.
2. When [Rename] is tapped, a keyboard appears on the screen.

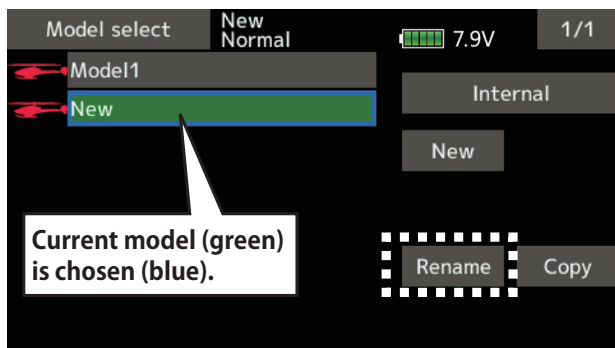

3. Enter the model name from this keyboard.
*Up to 15 characters can be input at the model name.

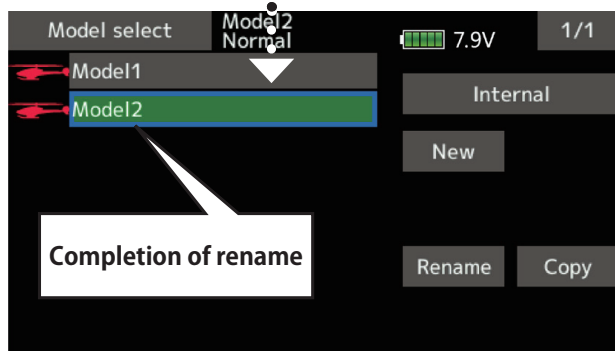
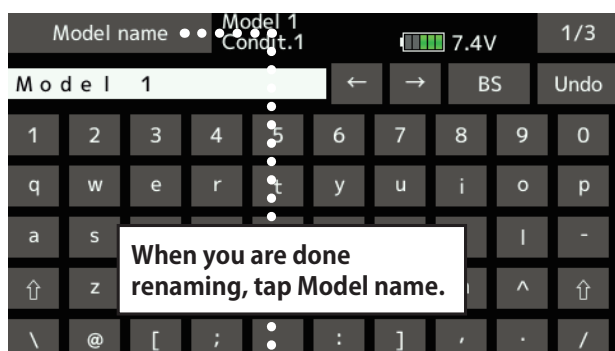

⚠ WARNING

- ⊘ Never launch the Model Selection function while the engine is starting or the motor drive wiring is connected.

- Careless spinning of propellers or rotors is extremely dangerous.

⚠ WARNING

- ⚠ Carefully check that the aircraft to be used and the model selected match up.

- Using a model which does not match the aircraft runs the risk of the aircraft flying out of control and crashing. Perform a careful operations check prior to flight.

Model copy

1. The model data chosen at current model can be copied. The current model name, tap.

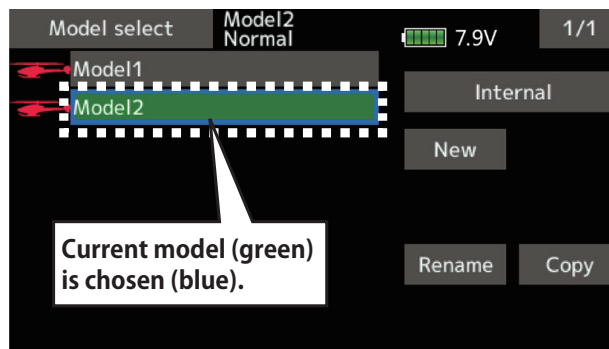

2. Tap the "Copy" button and tap the destination button and select the copy storage destination. (Internal or SD card)

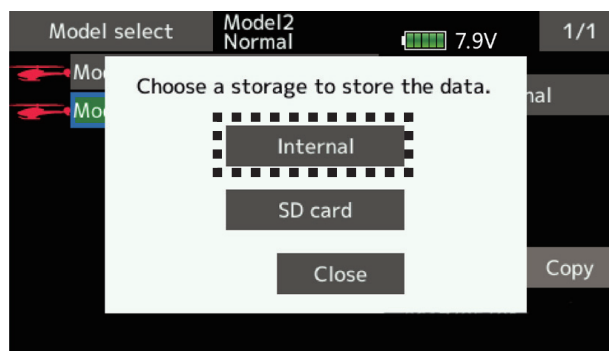

3. When [Internal] or [SD card] is tapped, copying is executed.

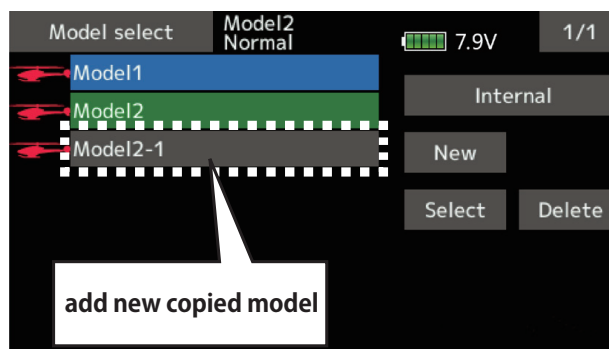

*If there is no model with the same name in the copy destination, the name of the copied model is saved. If there is a model of the same name, a number is added at the end of the model name and the model is copied. You can change the name later.

*Indication date : When the model data is copied, the creation date for the current model is recorded.

*T16IZ SUPER can use model data of T16SZ, T18SZ, FX-36, FX-32. Other transmitter model data is not available. However, if the model data conversion function (described at the end of this manual) is used, part of the model data of T14SG, FX-22, T12K can be used.

Model type

This function selects the model type from among airplane, glider, helicopter, and multicopter.

Seven types of main wings (six types of flying wing) and three types of tail wings are available for airplanes. Eight swash types are available for helicopters. Seven types of main wings and three types of tail wings are available for gliders. Functions and mixing functions necessary for each model type are set in advance at the factory.

Note: The Model Type function automatically selects the appropriate output channels, control

functions, and mixing functions for the chosen model type.

When the Model Type Selection command is accessed, all of the data in the active memory is cleared. Be sure that you don't mind losing this data, or back it up to another memory using the copying functions.

(The display screen is an example. The screen depends on the model type.)

- Select [Model type] at the linkage menu and call the setup screen shown below.

- Return to Linkage menu

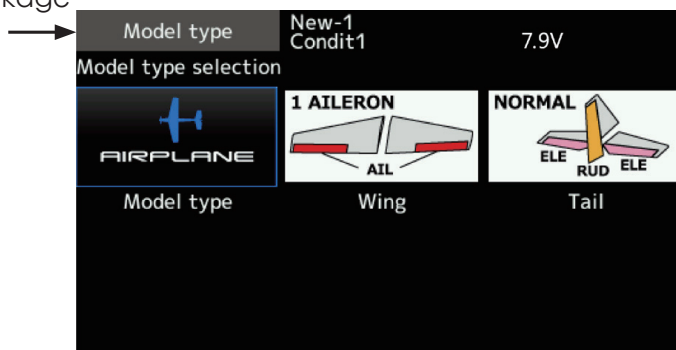



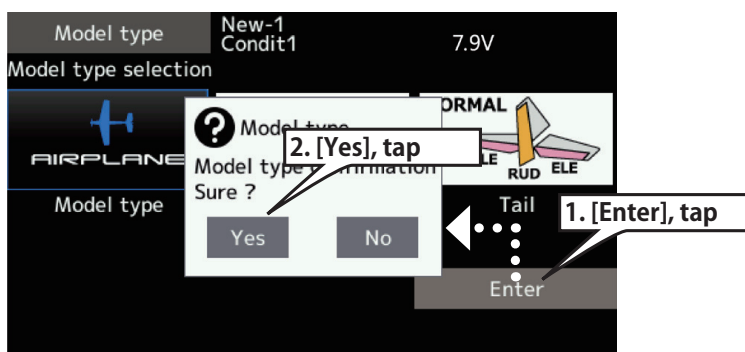

Model type selection

1. Model type selection [Model icon], tap.
2. Set the Model type, Wing type(Airplane/Glider), Tail type(Airplane/Glider), or Swash type(Helicopter) by using the appropriate button.
3. Set the type you choose by tapping [Enter]→[Yes] at the confirmation screen. (When you want to cancel model type selection, tap [No].)

- When a data change will occur, the confirmation screen of data initialization menu will be displayed. A push on [yes] will initialize data and allow changes. A push on [no] will stop data changes.









Model type	New-1 Condit1	7.9V
Model type selection		
 AIRPLANE	 HELICOPTER	 GLIDER
Airplane	Helicopter	Glider
 MULTICOPTER		
Multicopter		





Set the type you choose by tapping.



Airplane/Glider : Choose the wing type and tail.





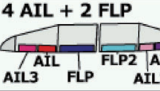
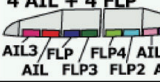

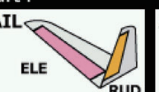
Helicopter : Choose the swash type.



Model type	New-1 Condit1	7.9V
Model type selection		
 AIRPLANE	 1 AILERON	 NORMAL
Model type	Wing	Tail

Swash	New-1 Condit1	7.9V
H-1 Pure function 	H-2 PIT 	H-4 ELE PIT AIL ELE2 
HR3(120°) PIT ELE AIL 	HN3(120°) ELE AIL PIT 	H-3 PIT AIL ELE 
HE3 PIT AIL ELE 	H-4X ELE PIT AIL ELE2 	Swash type selection

Wing	New-1 Condit1	7.9V	1/2
 1 AILERON	 2 AILERON	 2 AIL + 1 FLP	
 2 AIL + 2 FLP	 2 AIL + 4 FLP	 4 AIL + 2 FLP	
 4 AIL + 4 FLP	Wing type selection		

Tail	New-1 Condit1	7.9V
 NORMAL	 V-TAIL	 AILVATOR
Tail type selection		

Wing	New-1 Condit1	7.9V	2/2
 Flying Wing 2AIL	 Flying Wing 2AIL+1FLP		
 Flying Wing 2AIL+2FLP	 Flying Wing 2AIL+4FLP	 Flying Wing 4AIL+2FLP	
 Flying Wing 4AIL+4FLP	Wing type selection		

Tail	New-1 Condit1	7.9V
 Normal Rudder		
 Winglet (2RUD)		
Tail type selection		

Servo Reverse

Use to reverse the servo throw direction.

Servo Reverse changes the direction of an individual servo's response to a control stick movement.

For CCPM helicopters, be sure to read the section on Swash AFR before reversing any servos. With CCPM helicopters, always complete your servo reversing prior to any other programming. If you use pre-built Airplane/Glider functions that control multiple servos, it may be confusing to tell whether the servo needs to be reversed or a setting in the function needs to be reversed. See the instructions for each specialized function for further details. Always check servo direction prior to every flight

as an additional precaution to confirm proper model memory, hook ups, and radio function.

⚠ WARNING

! Before a flight, always check that your model's servo operation, the direction of control surfaces, and switch setup are correct.

! Default setting of the throttle/motor channel is always reverse.

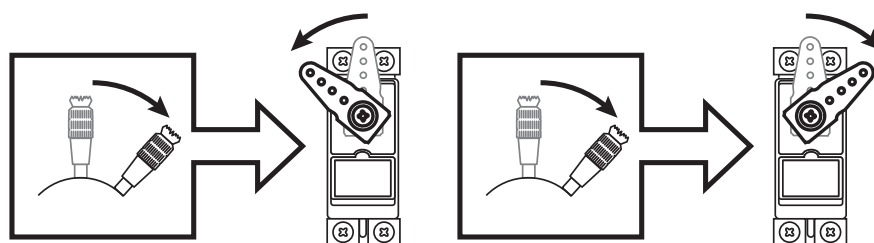

- Tap the [Servo reverse] button in the Linkage menu to call the setup screen shown below.

•Return to Linkage menu →

Servo reverse		New-1	7.9V	1/2
Ch	Function	Condit1	Ch	Function
1	Aileron	Normal	7	Auxiliary5
2	Elevator	Normal	8	Auxiliary4
3	Throttle	Reverse	9	Auxiliary3
4	Rudder	Normal	10	Auxiliary2
5	Gear	Normal	11	Auxiliary1
6	Air brake	Normal	12	Auxiliary1
				Normal

Tap the channel you wish to reverse.

? Sure ?

Yes No

Tap the "Yes" → Reverse

(The display screen is an example. The screen depends on the model type.)

Servo reversing procedure

After setting up a new model, be sure to define all special menus. Be sure that all servos are plugged into the proper receiver channels. Now, determine whether you need to reverse any channels by moving each stick and observing the corresponding movement in the model's controls.

1. Tap the desired channel's setting button to choose the proper direction for the servo.
2. Tap "Yes" in the next screen.
3. Repeat for each servo needing reversal.

When done, tap "Servo reverse" to return to the Linkage menu.

End point

Sets the travel, limit point.

The End point function adjusts the left and right servo throws, generates differential throws, and will correct improper linkage settings.

The travel rate (normal full stick movement at high rates) can be varied from 30% to 140% in each direction on channels 1 to 16. Also, the limit point (how far the servo travels when a mix is involved) where servo throw stops may be varied from 0% to 155%.

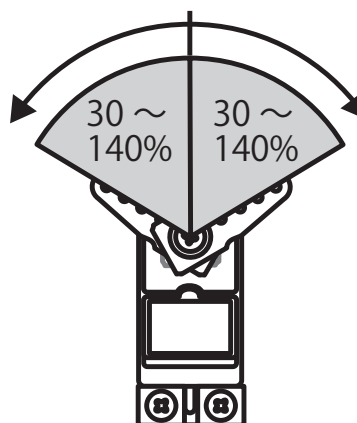

- Tap the [End point] button in the Linkage menu to call the setup screen shown below.

- Return to Linkage menu →

End point		New-1 Condit1	Travel rate	Limit point	7.9V	1/3
Ch	Function	Limit	Travel		Travel	Limit
1	Aileron	135	100		100	135
2	Elevator	135	100		100	135
3	Throttle	135	100		100	135
4	Rudder	135	100		100	135
5	Gear	135	100		100	135
6	Air brake	135	100		100	135

Next page Ch7-16

Tap the values you wish to adjust and value input buttons will appear on-screen.

Left / Top Right / Bottom

Indicates the current direction of the stick, etc.

(The display screen is an example. The screen depends on the model type.)

Servo travel adjustment

1. Tap the travel button of the channel you want to set. Value input buttons appear on the screen.
2. Use these buttons to adjust the rate.
 - Initial value: 100%
 - Adjustment range: 30%~140%
3. Repeat the procedure above for each rate.

Limit point adjustment

1. Tap the limit button of the channel you want to set.
2. Use the value input buttons to adjust the limit point.
 - Initial value: 135%
 - Adjustment range: 0%~155%
3. Repeat this procedure for each limit point.

Servo speed

Sets the speed of each servo.

The Servo speed setting is used to set the servo delay for each channel, from channel 1 to channel 16. The system uses the programmed speed (delay) to slow down servo position changes. The Servo

speed setting can be varied from 0 to 27 in each channel.

- Tap the [Servo speed] button in the Linkage menu to call the setup screen shown below.

- Return to Linkage menu

Servo speed		New-1 Condit1	7.9V	1/2
Ch	Function		Ch	Function
1	Aileron	0	7	Auxiliary5
2	Elevator	0	8	Auxiliary4
3	Throttle	0	9	Auxiliary3
4	Rudder	0	10	Auxiliary2
5	Gear	0	11	Auxiliary1
6	Air brake	0	12	Auxiliary1

(First) 0 ~ 27 (Slowly)

Servo speed setting

1. Tap the speed button of the channel you want to set.
2. Use the value input buttons to adjust the servo speed.
 - Initial value: 0
 - Adjustment range: 0~27 (steps)

3. Repeat this procedure for each channel.

To close this screen, tap the [Servo speed] button.

Sub-trim

Setting of neutral position of each servo.

The Sub-Trim function is used to set the servo neutral position, and may be used to make fine adjustments to the control surface after linkages

and pushrods are hooked up. When you begin to set up a model, be sure that the digital trims are set to their center position.

- Tap the [Sub-trim] button in the Linkage menu to call the setup screen shown below.

- Return to Linkage menu

Sub-trim		New-1 Condit1	7.9V	1/2
Ch	Function		Ch	Function
1	Aileron	+0	7	Auxiliary5
2	Elevator	+0	8	Auxiliary4
3	Throttle	+0	9	Auxiliary3
4	Rudder	+0	10	Auxiliary2
5	Gear	+0	11	Auxiliary1
6	Air brake	+0	12	Auxiliary1

Sub-trim adjustment

1. Tap the trim display part of the channel you want to adjust.
Value input buttons appears on the Sub-trim menu screen.

2. Use the value input buttons to adjust the sub trim.
 - Initial value: 0
 - Adjustment range: -240~+240 (steps)
*See above
3. Repeat this step for each channel.

Function

Channel assignment for each function can be changed to suit your needs.

When you select model and wing (swash) types, you will find that the optimized combinations of servo output channels and functions have been already preset. If you would like, on the function-setting screen of the linkage menu, you can freely change combinations of servo output channels, functions (aileron, elevator, etc), and input controllers (sticks, switches, trim levers and trim switches). You can also assign the same function to multiple servo output channels such as assigning elevator function to CH2 and CH3.

DG1, DG2 (switch channels)

These two channels can be used as switch (On/Off) channels. You can freely change combinations between servo output channels and input controllers (sticks, switches, trim levers and trim switches).

Channel restrictions by a System Type

FASSTest 18CH---16 CH+2 Switch
 FASSTest 12CH---10 CH+2 Switch
 FASST MULTI ---16 CH+2 Switch
 FASST 7CH --- 7 CH
 S-FHSS --- 8 CH
 T-FHSS ---16 CH+2 Switch

- Tap the [Function] button in the Linkage menu to call the setup screen shown below.

•Return to Linkage menu →

Ch	Function	Control	Trim
1	Aileron	J1	T1
2	Elevator	J3	T3
3	Throttle	J2	T2
4	Rudder	J4	T4
5	Gear	SG	--
6	Air brake	RS	--

Diagram showing navigation arrows from the 'Function' column to the 'Function change' section and from the 'Control' and 'Trim' columns to the 'Operation control change' section.

Function change

1. Tap the function button of the channel you want to change to call the Function select.

Function select	New-1 Condit1	7.9V
Aileron	Aileron2	Fuel mix
Elevator	Aileron2	Gyro
Throttle	Aileron4	Gyro2
Rudder	Elevator2	Gyro3
Gear	Flap2	Throttle2
Flap	Air brake	Throttle3

2. Select the function you want to change.

Operation control change

1. Tap the control button of the channel you want to change. A control select screen (stick, switch, knob, trim lever, etc.) is displayed.

Hardware select	New-1 Condit1	7.9V		
--	J1	SA	SG	T1
	J2	SB	SH	T2
	J3	SC		T3
	J4	SD		T4
	RD	SE	RS	
	LD	SF	LS	

2. Select the control you want to operate.

*The same control can be assigned to multiple channels.

Trim change

1. Tap the trim button to call the trim setup screen.

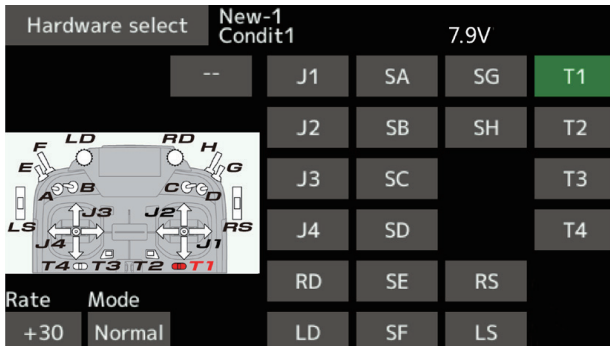

2. The following items can be set at the trim setup screen.

- Hardware setting (Selection of switch, etc. which controls trim)
- Rate setting
- Trim mode setting

Normal mode: Normal trim (linear) operation

ATL mode: ATL operation mode. (Works at only one end of operation) Reverse is also possible.

Center mode: Maximum change near center by center trim operation (Does not change at end of the stick movement)

The Motor function is used when switching the motor ON/OFF (mostly for motor gliders). For most EP planes, the throttle can be left as-is when controlling the motor by stick. This means that the various throttle-related functions are usable via motor control.

H/W reverse

This function reverses the operation signal of the sticks, switches, trim levers, and knobs.

Note: This setting reverses the actual operation signal, but does not change the display of the indicators on the display. Use the Normal mode as long as there is no special reason to use the reverse mode.

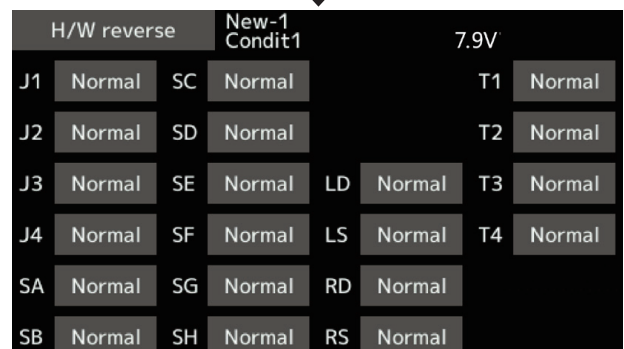

Tap the channel you wish to reverse.

Tap the "Yes"
→ H/W reverse

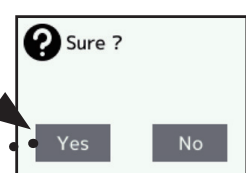

Fail safe

Sets the servos' operating position when transmitter signals can no longer be received or when the receiver battery voltage drops.

The Fail safe function is used to set up positions that the servos will move to in the case of radio interference. Defines servo position when signals are lost and when receiver battery voltage becomes low. You may set either of two positions for each channel: Hold, where the servo maintains its last commanded position, or fail safe, where each servo moves to a predetermined position. You may choose either mode for each channel.

The T16IZ SUPER system also provides you with an advanced battery monitoring function that warns you when the receiver battery has only a little power remaining. In this case, each servo is moved to the defined failsafe position. The battery failsafe may be released by operating a predefined control on the transmitter (default is throttle). Do not continue to fly. Land as soon as possible. Remember, if the predefined control suddenly moves to a

position you did not command, land at once and check your receiver battery.

Do not continue to fly. Land as soon as possible. Defines servo position when signals are lost and when receiver battery voltage becomes low.

WARNING

For safety, always set the fail safe functions.

- Especially set the throttle channel fail safe function so that the servo moves to the maximum slow side for airplanes and to the slow side from the hovering position for helicopters. Crashing of the model at full high when normal radio waves cannot be received due to interference, etc., is very dangerous.
- If fail safe is reset by throttle stick movement, the fail safe may be mistaken as an engine malfunction and will be reset at low throttle and the model will continue to fly. If you have any doubts, immediately land.

- Tap the [Fail safe] button in the Linkage menu to call the setup screen shown below.

• Return to →
Linkage menu

Fail safe		New-1 Condit1	7.9V		1/3
Ch	Function	Mode	B.F/S	F/S-POS	Release battery F/S
1	Aileron	Hold	OFF	+0	Release battery F/S
2	Elevator	Hold	OFF	+0	--
3	Throttle	Hold	OFF	+0	
4	Rudder	Hold	OFF	+0	
5	Gear	Hold	OFF	+0	
6	Air brake	Hold	OFF	+0	

Fail safe setting procedure

Decide which channels you want to go to preset positions, and which ones you want to maintain their last commanded position. To select the fail safe mode you wish to set, use the F/S button. This button toggles between the two modes. (Hold, F/S)

F/S mode setting:

1. Tap the F/S button of the channel you want to set, and set that channel to the [F/S] mode.
2. Hold the corresponding stick, control, slider, or other control in the position you want the servo to move to when the fail safe function is activated, and tap the F/S position button. That position is displayed in percentage.

*When you want to return that channel to the Hold mode, tap the [F/S] button again.

Battery fail safe setting procedure

To select the B.F/S mode, tap the [B.F/S] button. Each time the button is tapped, it toggles between [OFF] and [B.F/S].

B.F/S setting:

1. Tap the [B.F/S] button of the desired channel to set it to the B.F/S mode.
2. Hold the corresponding stick, VR, slider, or other control in the position you want the servo to move to when the battery fail safe function is activated, and tap the F/S position button. This position is displayed in percentage.

*When you want to return that channel to OFF, tap the [B.F/S] button again.

Battery Fail safe release function

This function releases the predefined control from its held position after indicating that your receiver battery is low.

1. Enter the control setting screen by tapping the Battery F/S release button. Now, you may choose whether moving the throttle resets the condition, or select a stick or switch to deactivate it. To set a desired throttle release position, move the throttle stick to the point at which you wish the B.F/S to be released.

System type

System mode setting, Receiver link

***FASST MULTI/FASST 7CH cannot be selected for Europe.**

System Type selection

The T16IZ SUPER is for 2.4 GHz only. The system can be changed from among 6 choices: FASSTest 18CH, FASSTest12CH, FASST MULTI, FASST 7CH, T-FHSS, S-FHSS. It is FASSTest18CH and FASSTest12CH which can be chosen by R7208SB or R7308SB set. The method of selection is on the next page.

- *If you change the System type, other model data is not reset.
- *After any change, remember to test the model and fully check servo direction and motion.
- *Analog servos cannot be used with the R7208SB or R7308SB in the FASSTest12CH mode.

Dual receiver function (only FASSTest 18CH)

Dual receivers can be linked with the T16IZ SUPER. Two receivers are recognized individually by ID numbers. For example, in R7208SB or R7308SB, CH output setting function is used, by setting the first as "1-8CH", and setting the second as "9-16CH". Two sets of receivers can be used as a set in the model, allowing you 16 channels. Separate fail-safe voltage can be set to each receiver.

However, telemetry cannot be used for the 2nd receiver.

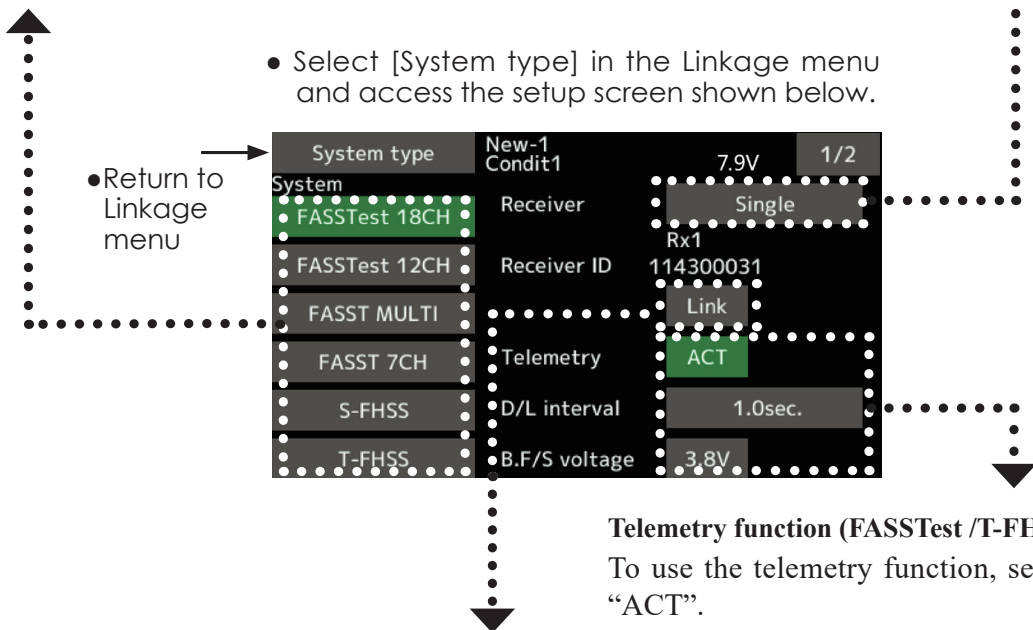

Telemetry function (FASSTest /T-FHSS mode only)

To use the telemetry function, set "Telemetry" to "ACT".

DL Interval (FASSTest mode only)

When a telemetry function is enabled, the receiving interval (down-link interval) of sensor data can be changed.

If a DL interval is increased, the response of the sensor data display becomes slower, but stick response will improve.

Receiver linking

The receiver will only be controlled (without being affected by other transmitters) by the transmitter it is linked to. When using a receiver other than one purchased as a set, linking is necessary.

Moreover, a re-link is required when a new model is added by model selection, and at the time of system type change.

Linking method



Cases when linking is necessary:

- When using a receiver other than the initial setting.
- When the communication system was changed. (FASSTest18CH ↔ FASSTest12CH etc.)
- When a new model was created by model selection.

Battery fail-safe voltage setup (FASSTest /T-FHSS mode only)

The voltage at which battery fail-safe activates can be set when you link. (3.5-8.4 V) The receiver memorizes the setting as it was at link.

Since power consumption varies with battery type, servos and condition, please select the fail-safe activation voltage for your own model.

CRSF Protocol for TBS

T16IZ SUPER has been made compatible with the CRSF (TBS) protocol.

- Call page 2/2 from the [System type] menu.

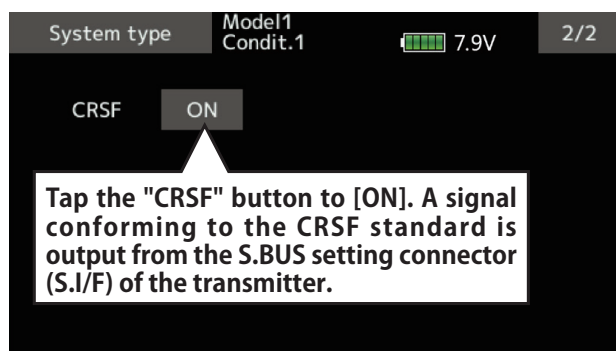

*Bidirectional communication function of CRSF is not supported.

*When using CRSF, the S.BUS servo setting function and [Reload] [Register] [Change slot] functions cannot be used. When setting S.BUS servo and sensor, set CRSF to INH.

WARNING

 Futaba is not responsible for damage sustained by combination with parts other than Futaba Genuine equipment.

System type

- FASSTest 18CH --- FASSTest system receiver mode. Applicable with the telemetry sensor unit. Up to 18 channels (linear16+ON/OFF2) can be used.
- FASSTest 12CH --- FASSTest system receiver mode. Applicable with receiver voltage display. Up to 12 channels (linear10+ON/OFF2) can be used. Telemetry Sensor cannot be used, but the response speed is faster than that of the 18CH mode.
 - Analog servos cannot be used with the R7208SB (R7308SB) in the FASSTest 12CH mode.
- FASST MULTI --- FASST-MULTI system receiver mode. Up to 18 channels (linear16+ON/OFF2) can be used.
- FASST 7CH --- FASST-7CH system receiver mode. Up to 7 channels can be used.
- T-FHSS Air --- T-FHSS system receiver mode. Applicable with the telemetry sensor unit. Up to 18 channels (linear16+ON/OFF2) can be used.
- S-FHSS --- S-FHSS system receiver mode. Up to 8 channels can be used.

*FASST MULTI/FASST 7CH cannot be selected for Europe.

Trim setting

Digital trim settings

This function adjusts the digital trim's control step amount and operation mode (T1-T4).

When the flight conditions are set, the trim operation can be coupled with any of the conditions selected through combination mode.

- Select [Trim setting] at the linkage menu and call the setup screen shown below.
- Return to Linkage menu →



Control step amount setting

1. To set the control step amount, first tap the screen to the data input mode.

Set the control step amount by tapping the "▲▲""▲""▼▼""▼" button.

Initial value: 4

Adjustment range: 1~200

(When the value is tapped, the control step amount is reset to the initial value.)

*When the value is made large, the change per step becomes larger.

Separate/combination mode selection

[Comb.]: Combination mode. The trim data are reflected at all the flight conditions.

[Separ.]: Separate mode. Trim adjustment for each flight condition.

Throttle cut Stops the engine safely and easily.

Throttle cut provides an easy way to stop the engine, by flipping a switch with the throttle stick at idle. The action is not functional at high throttle to avoid accidental dead sticks. The switch's location and direction must be chosen, as it defaults to " — ".

- Tap the [Throttle cut] button in the Linkage menu to call the setup screen shown below.

- Return to Linkage menu →

Throttle cut setting procedure

1. Tap the "INH" button.
2. Throttle cut function switch setting:
Tap the "--" button to call the <Hardware select> screen, and then select the switch and its ON direction.
(For a detailed description of the selection method, see [Switch selection method] at the back of this manual.)
3. Throttle cut position setting:
Tap the cut position button. Value input buttons appear on the screen.
Use these buttons to adjust the cut position rate.

- Initial value: 17%
- Adjustment range: (LOW) 0%~50% (Middle)
- *With throttle stick at idle, adjust the rate until the engine consistently shuts off.

To exit the setting, tap the [Throttle cut] button.

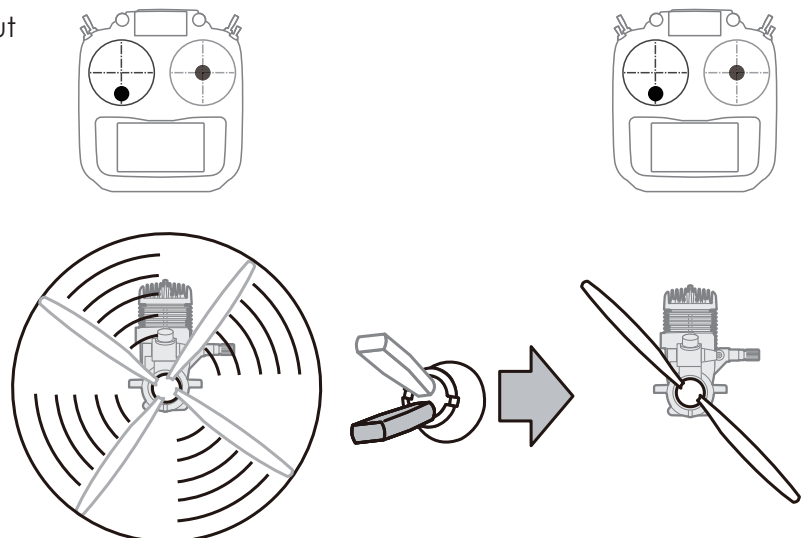

Idle down

Lowers the engine idling speed.

The Idle down function lowers the engine's idle by flipping a switch with the throttle stick at idle. The action is not functional at high throttle to avoid accidental dead sticks. The switch's location and direction must be chosen, as it defaults to " -- ".

- Select [Idle down] at the linkage menu and call the setup screen shown below.

- Return to Linkage menu

Idle down New-1 Condit1 7.9V

ACT/INH INH

Offset +0

Switch --

Tapping this will change INH to either OFF or ON and activated.

This is the idle down throttle position. Tapping this will display value input buttons on-screen. Set the engine's max. low position.

Range:
(↑) -100 ~ +100 (↓)
Pressing and holding a value will reset it to 0.

Tapping this will pull up the hardware selection screen. Select the idle down switch and ON-OFF direction.

This is the current position bar for the throttle stick. Throttle cut will only function when the throttle stick is more than halfway into the low throttle range.

Idle down setting procedure

1. Tap the "INH" button to activate the Idle down function.
2. Idle down function switch setting:
Tap the "--" button to call the <Hardware select> screen, and then select the switch and its ON direction.
(For a detailed description of the selection method, see [Switch selection method] at the back of this manual.)

3. Offset rate setting:
Tap the offset rate button. Value input buttons appear on the screen.
Use these buttons to adjust the offset rate.
 - Initial value: 0%
 - Adjustment range: -100%~100%
 - *(-) becomes an idle up.

To exit the setting, tap the [Idle down] button.

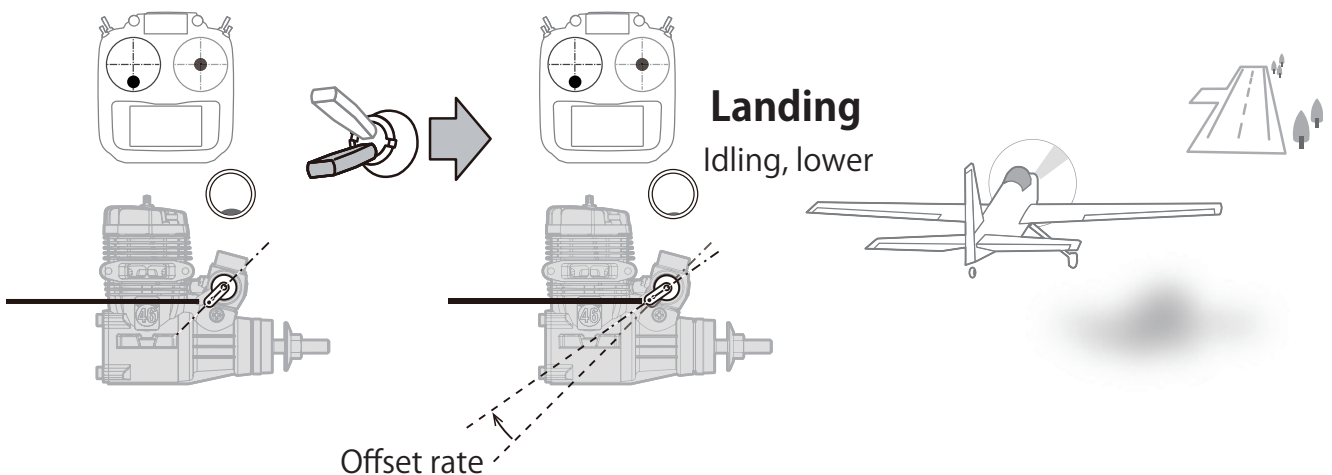

Swash ring

Limits the swash travel within a fixed range to prevent linkage damage (Helicopter only)

This function limits the travel of the swash plate to prevent linkage damage as the aileron and elevator operation is used. It is useful for 3D heli setting.

- Tap the [Swash ring] button in the Linkage menu to call the setup screen shown below.

• Return to Linkage menu →

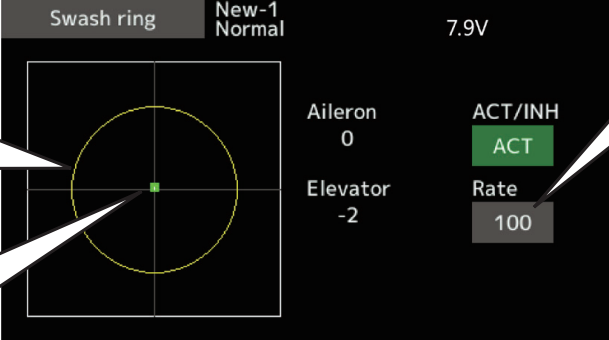

The movement range display shows control input for elevator and aileron direction.

The marker represents the stick's position.

Setting the function to "ACT" will display the swash ring and [Rate] percentage.

Swash ring setting procedure

1. Push the Swash ring button on the linkage menu.
2. Push ACT/INH button to activate.
*The movement area monitor shows the current aileron and elevator values and limit ranges by the yellow circle.
3. Adjust the rate to the maximum amount of swash plate decline.
*The swash movement is limited within the circle.
Adjustment range: 50 - 200%.

Swash

Swash operation linkage correction function (helicopter only, except swash type H-1).

Neutral Point

At your linkages, if the servo horn deviates from a perpendicular position at neutral, the linkage compensation functions in this menu may not compensate effectively. To correct this use the neutral point function. This will move the neutral point of the servos to the actual perpendicular position. However, this adjustment changes only the axis point of the compensation functions in this menu, and does not affect the neutral position of other functions.

Swash AFR

Swash AFR function reduces/increases/reverses the rate (travel) of the aileron, elevator and collective pitch functions, by adjusting or reversing the motion of all servos involved in that function, only when using that function.

Mixing Rate

This compensation mixing is used to correct the tendency of the swash-plate for each control. The following compensation mixing is possible: PIT to AIL, PIT to ELE, AIL to PIT, ELE to AIL, and ELE to PIT (HR3 mode.) It adjusts the swash-plate to operate correctly for each control using the corresponding compensation mixing.

Linkage Compensation

This compensation mixing is used to correct the tendency of the swash-plate for pitch control at low pitch and high pitch.

Speed Compensation

This function is used to cancel the reaction that is generated by the difference of the operation amount of each servo when the swash-plate moves.

- Select [Swash] at the linkage menu and call the setup screen shown below.

- Return to Linkage menu

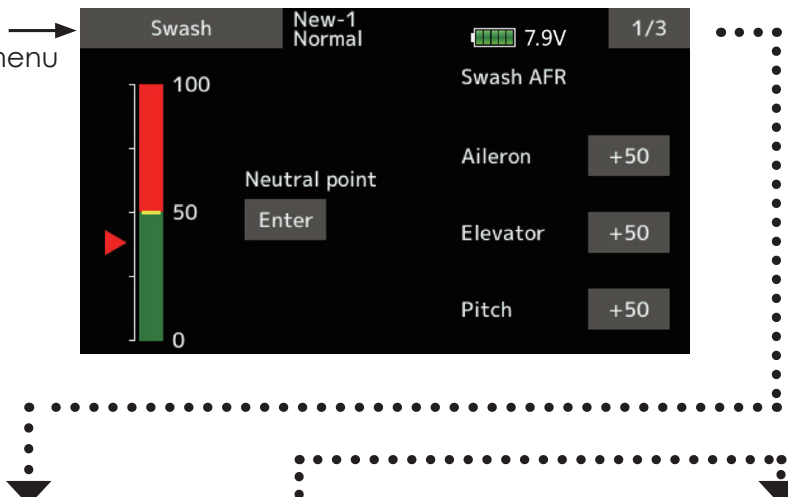

Swash New-1 Normal 7.9V 1/3

Swash AFR

Aileron +50

Elevator +50

Pitch +50

Neutral point Enter

100

50

0

Swash New-1 Normal 7.9V 2/3

Mixing rate

	←↑	↓→
PIT→AIL	100	100
PIT→ELE	100	100
AIL→PIT	100	100
ELE→AIL	50	50
ELE→PIT	50	50

Swash New-1 Normal 7.9V 3/3

Linkage compensation

Function Direction ←↑ ↓→

Aileron	+	0	0
Elevator	+	0	0

Speed compensation 0

Neutral point setting procedure

*Becomes the compensation reference point.

*Adjusting the servo horn so that the neutral point position is near the 50% position makes the mixing amount small.

1. Hold the servo horn at a right angle to the linkage rod, and then tap the [Enter] button and read the actual neutral point.

*The neutral point is displayed on the screen.

After reading this neutral point, use other compensation functions to make further adjustments.

To exit the setting, tap the [Swash] button.

Swash AFR setting procedure

Adjust so that the specified operation amount is obtained by aileron, elevator, and pitch operation.

1. Tap the button of the AFR rate to be adjusted. Value input buttons appear on the screen.
2. Use the value input buttons to adjust the AFR rate.

Initial value: +50%

Adjustment range: -100%~+100%

+or- the direction of operation changes.

To exit setting, tap the [Swash] button.

Mixing rate setting procedure

HR-3 is described as an example. The mixing applied in other swash modes is different, but the setting procedure is the same.

1. Set the throttle stick to the set neutral point. Adjust the length of the linkage rod so that the swash plate is horizontal at this position.
 - *A little adjustment using sub trim should be OK.
 - *Adjust so that pitch operation when the pitch curve is straight is maximum.
2. Adjust the AIL->PIT amount so there is no interference in the elevator or pitch direction when the aileron stick is moved to the left and right.
 - *Adjust the left and right sides separately.
3. Adjust the ELE->AIL and ELE->PIT amounts so there is not interference in the aileron or pitch direction when the elevator stick is moved up and down.
 - *Adjust the up and down sides separately.
4. Adjust the PIT->AIL and PIT->ELE amounts so that the swash plate is horizontal when the throttle stick is set to maximum slow and full high.
 - *Adjust the slow and high sides separately.

To exit setting, tap the [Swash] button.

Linkage correction setting procedure

*Set the linkage compensation after setting the mixing rate.

*This function compensates for elevator interference by aileron operation or aileron interference by elevator operation at Low pitch and Hi pitch at collective pitch (HR3, etc.) control.

1. Set the throttle stick to the maximum slow position. Move the aileron stick to the left and right and adjust the aileron compensation amount so that interference in the elevator or pitch direction at that time is minimal.

*The left and right sides can be adjusted separately.

*If the interference increases when the compensation amount is increased, make the compensation direction "-".

2. Adjust the elevator compensation amount so that the interference in the aileron or pitch direction when the elevator stick is moved up and down is minimal.
3. Perform aileron and elevator compensation similarly for the throttle stick full high side.
 - To exit setting, tap the [Swash] button.

Speed compensation setting procedure

1. Set the throttle stick to the neutral point position. Move the elevator stick quickly and adjust the speed compensation amount so that the interference in the pitch direction is minimal.

To exit setting, tap the [Swash] button.

Notes:

If the linkage is too long or short, correct compensation will not be applied. Correct this before continuing. The pitch angle changes after any adjustment. Reset the pitch angle when actually flying after compensation processing.

Stick alarm

An alarm (single beep) can be sounded at the specified throttle stick position.

- Alarm function ON/OFF can be set by switch.

•Return to Linkage menu →

Stick alarm New-1 Normal

ACT/INH INH

Position 50

Switch --

7.9V

100

50

0

Tapping this will change INH to ON and activated.

If the throttle stick reaches the yellow line, an alarm will sound.

This is the current position display bar for the throttle stick.

This is the throttle stick alarm position. Push the throttle stick to the desired position and tap the value.

Range: (Low) 0 ~ 100 (High)

Tapping this will pull up the hardware selection screen. Select the switch and ON-OFF direction if turning the function ON-OFF by switch.

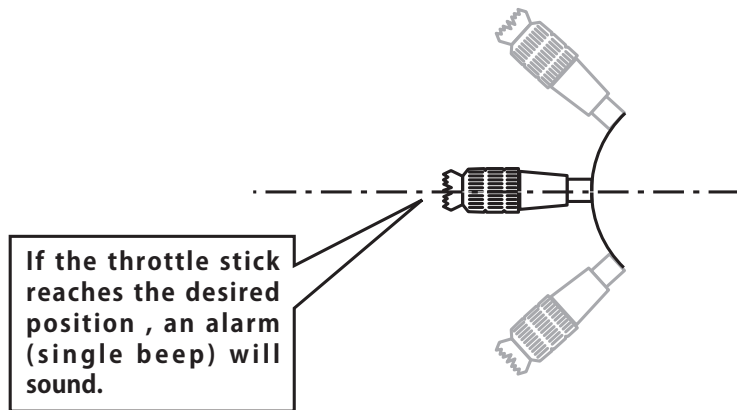

Timer

Timer setting

The Timer function may be set for any desired time, i.e. engine run time, specified times for competitions, etc. Two independent timers are provided for your use. The timers are stored independently with each model, meaning that when you switch between model setups, the timer associated with the new model is brought up automatically.

The timers may be set to start and stop from the motion of any switch or stick. You may set the ON and OFF directions freely. Each timer has a capacity of up to 59 minutes 59 seconds.

- Select [Timer] at the linkage menu and call the setup screen shown below.

Each timer may be set for count-down or count up operation with a target time. If a target time is set and the timer reaches the set time, a buzzer sound for each count is generated.

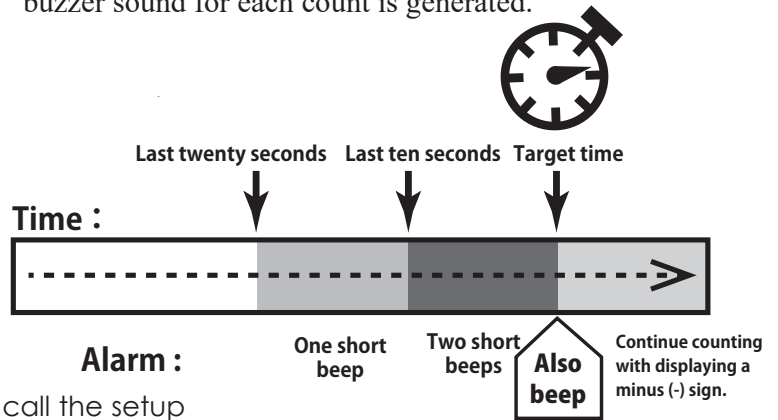

•Return to Linkage menu →

Elapsed: Minute-by-minute alarm starting from 00:00
Remainder: Minute-by-minute alarm counting down from a designated time

[Inhibit] → [Type1-4]
 If it carries out like this, a vibration function will work.

OFF: Turning the power OFF and switching models will reset the timer.
ON: Previous timer is put into memory and will restart from where it stopped.

A Buzzer or Speech can be chosen

Constant: The alarm does not stop
One time: Stop the alarm at once

The screenshot shows the 'Timer' setup screen for 'Model1 Condit.1'. It displays 'Timer1' with a time of '00:00.0'. Below the time are buttons for 'Reset', 'Elapsed', 'Buzzer', and 'Constant'. Further down are 'Mode' (Up), 'Vibrator' (Inhibit), and 'Memory' (OFF) options. Callouts explain the 'Elapsed' and 'Remainder' alarm types, the effect of the 'Inhibit' setting, and the 'OFF'/'ON' memory settings.

[Start/Stop] → Home screen
 A timer on the home screen starts and stops its countdown directly from there when tapped. Tapping and holding the display will reset the timer.

The screenshot shows the home screen with two timer displays, 'Timer 1' and 'Timer 2', both showing '00:00.0'. Below the displays are buttons for 'Sy', 'Linkage menu', and 'Model select'. The 'Timer 2' display is highlighted with a red box and labeled 'HELICOPTER'. The bottom of the screen shows the time '24:27:26'.

Up timer/Down timer selection

1. Tap the mode button and select the type of timer.
2. Timer time setting.
 Tap the Mode minutes or seconds button. Value input buttons appear on the screen. Use these buttons to set the timer time.

Start/Stop/Reset switch setting

1. Tap the Start/Stop/Reset SW "--" button to call the <Switch> screen, and then select the switch and its ON direction.
 (For a detailed description of the selection method, see [Switch selection method] at the back of this manual. The timer switches can be set for each condition.)

Integration Timer

INT (integration) Timer is the function which changes progress of a timer according to the location of the throttle stick. When the throttle stick is raised for faster speed, the speed of the timer usually increases. With the throttle stick at mid-range speed, the timer speed decreases (to 50%). When the throttle is positioned at low end, the timer's progress stops. It's possible to set it in the time which fits power consumption of your fuselage.

*The consumption of the battery/fuel is different depending on the conditions, so use an INT Timer as reference.

*The INT (integration) time is different from the actual elapsed time.

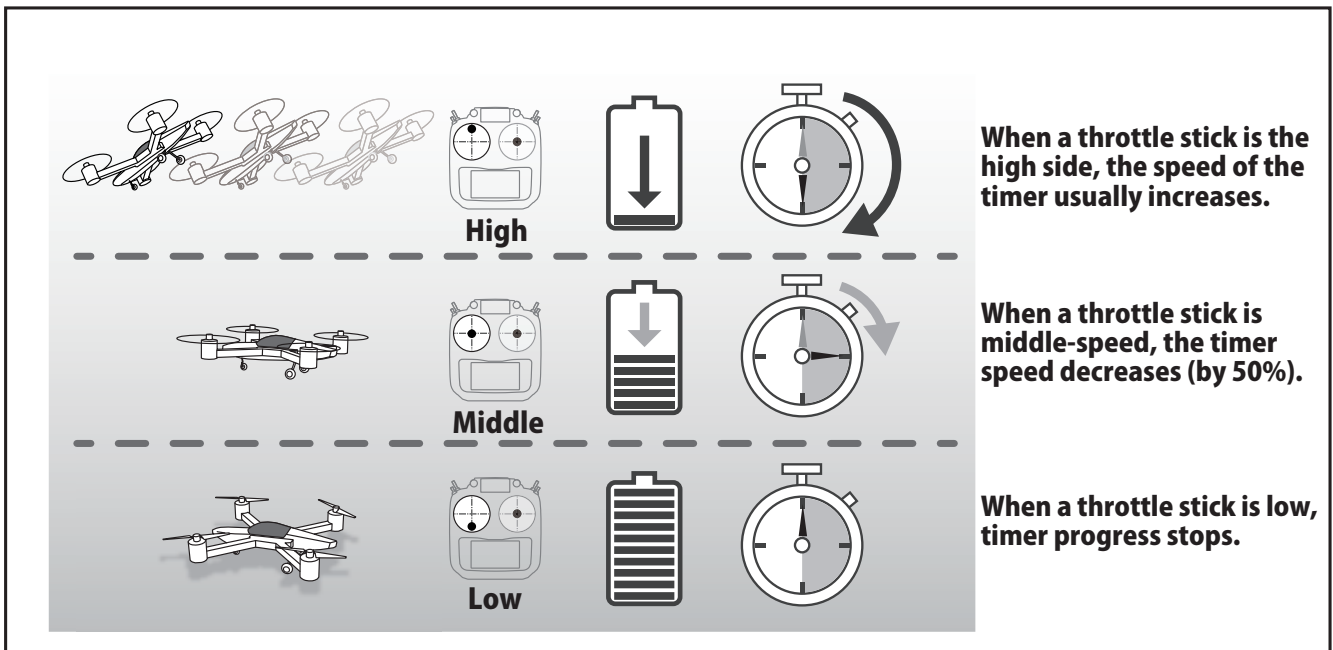

- Select [Timer] at the linkage menu and call the setup screen shown below.



Function name

Function name can be changed

The name of the spare functions (Auxiliary 1-8) can be changed for the full name (10 characters) or for the abbreviated name (4 characters).

- Tap the [Function name] button in the Linkage menu to call the setup screen shown below.

- Return to Linkage menu



Function name change method

1. Select [Function name] from the Linkage menu and tap the screen.
2. The Function name setup screen is displayed.
3. When the function whose name is to be changed is selected and the screen is tapped, a modification screen is displayed.
4. Select the function to be renamed and select [Rename] and tap the screen. A character input screen is displayed. Input the function name.
6. The function name may be displayed in 10 characters or 4 characters, depending on the setup screen. For 4-character display, input the function name as required.

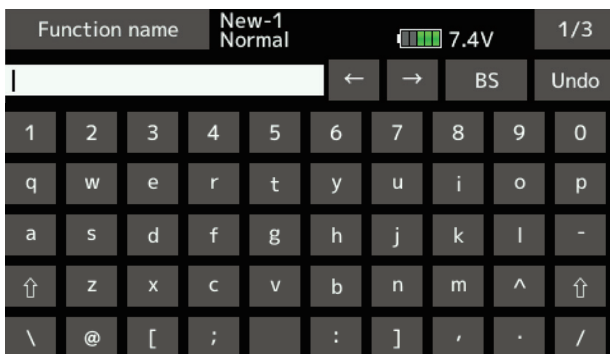

5. When [Reset] is selected and the screen is held down, the function name is set to the initial state function name.

Telemetry system

This screen displays and sets the various information from the receiver. An alarm and vibration can be generated depending on the information. For example, a drop in the voltage of the receiver battery housed in the aircraft can be reported by an alarm.

- This function can only be used in the FASSTest18CH mode and T-FHSS mode. The FASST/S-FHSS mode cannot use telemetry.
- FASSTest12CH mode. Applicable with receiver voltage display.
- Telemetry sensors sold separately can be mounted in the aircraft to display a variety of information. (Receiver voltage does not require a sensor.)
- The telemetry function cannot be used if the telemetry mode of the parameters is not ACT.
- FASSTest18CH : When 2 receivers are used with 1 transmitter, the telemetry cannot be used for the 2nd receiver.
- T-FHSS/FASSTest12CH : When 2 receivers are used with 1 transmitter, the telemetry function cannot be used.
- If the transmitter and receiver are linked, but the receiver's ID is not recorded in the transmitter's memory, the telemetry function cannot be used.
- Turning OFF the receiver after use will cause the telemetry data just prior to this to be displayed. (Even when the receiver's power is turned OFF, the receiver voltage is not 0.0 V.)

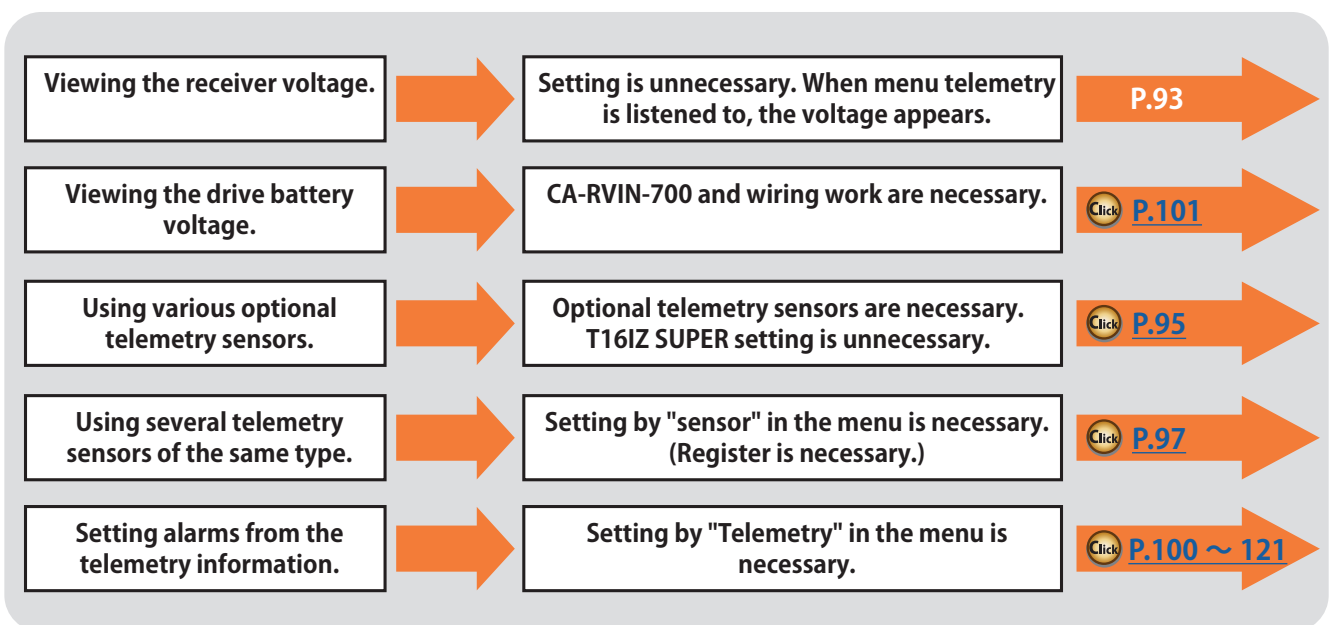

Viewing the telemetry data

Receiver → Transmitter. The reception of the signal from the receiver to the transmitter is shown. This does not affect flight.

Receiver voltage and Ext voltage display

CAUTION

- ❗ Do not stare at or set the transmitter setting screen while flying.
- Losing sight of the aircraft during flight is very dangerous.
- When you want to check the information during flight, call the telemetry screen before flight and have the screen checked by someone other than the operator.

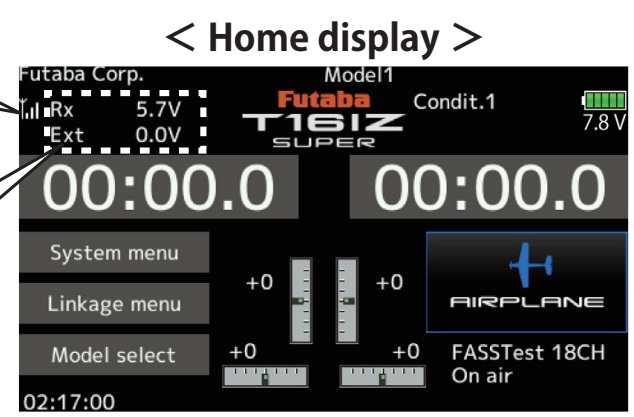

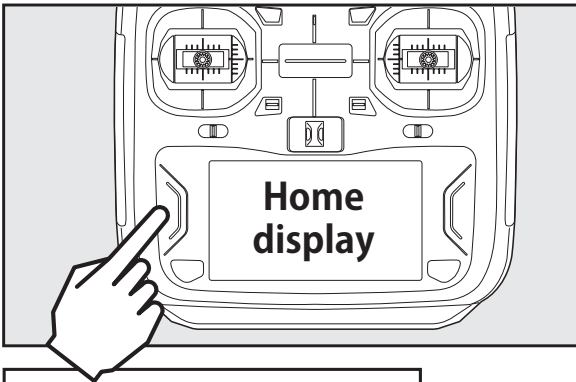

HOME/EXIT is pushed

*Be aware that pressing and holding this activates the key lock

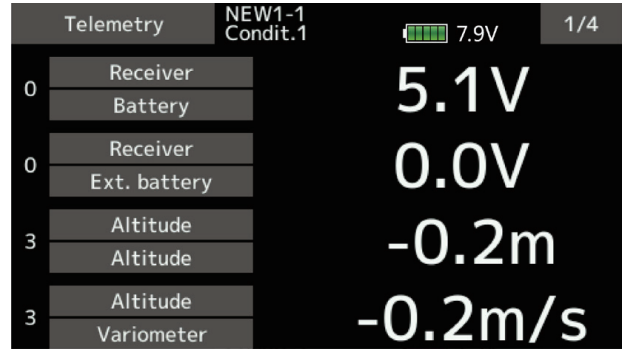

16 of telemetry data is displayed

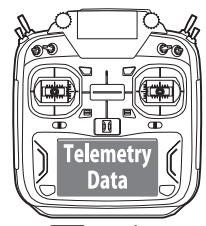
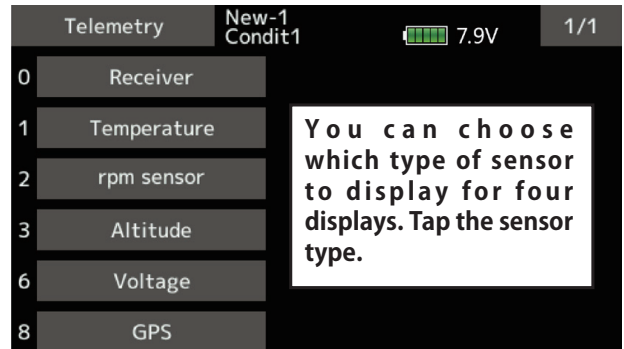
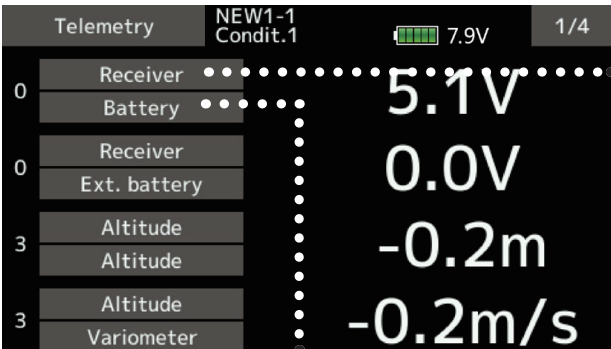

Telemetry Schematic

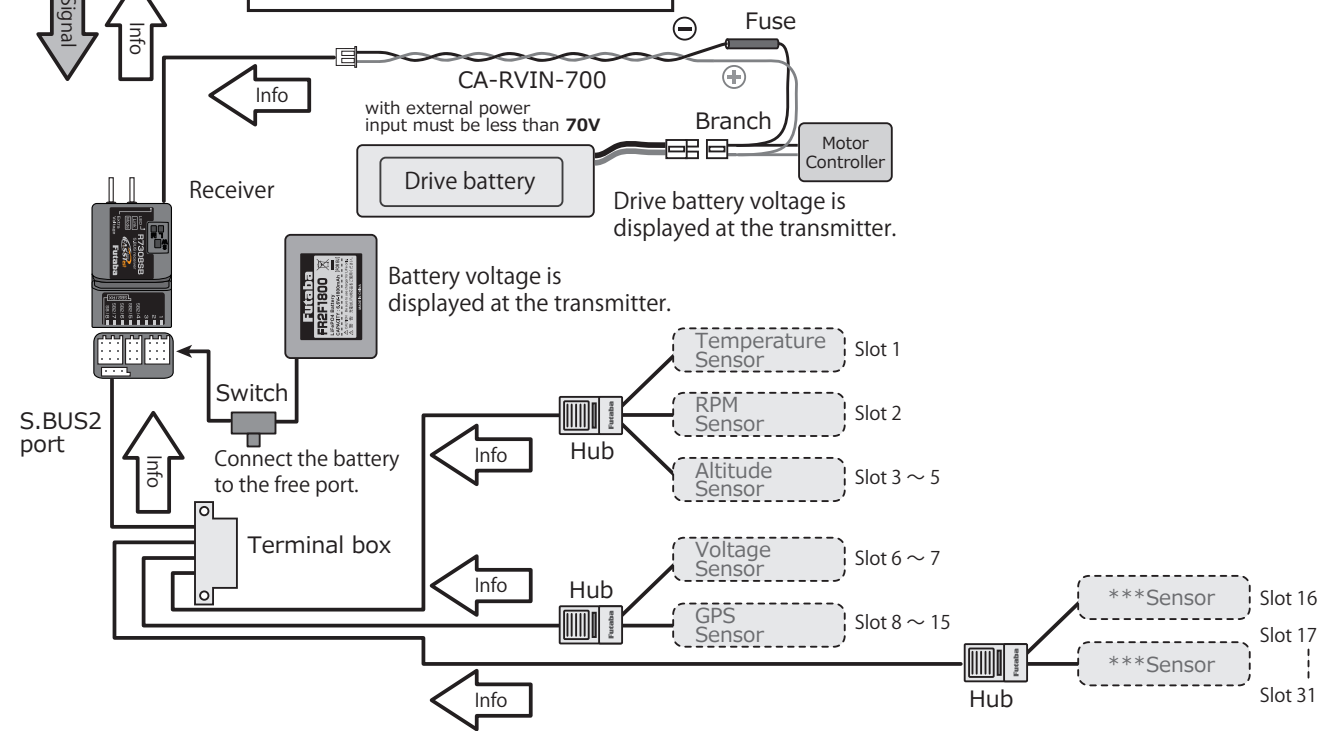
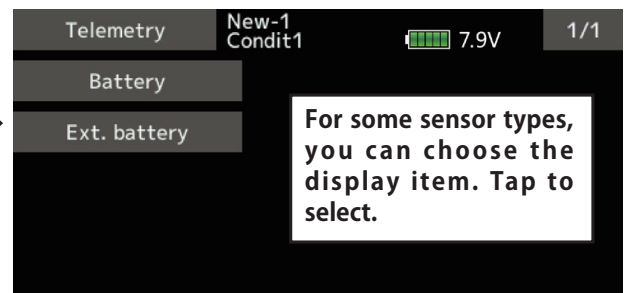

Sensor

Various telemetry sensors setting

This screen registers the telemetry sensors used with the transmitter. When only one of a certain type of sensor is used, this setting is unnecessary and the sensor can be used by simply connecting it to the S.BUS2 port of the transmitter.

When using 2 or more of the same kind of sensor, they must be registered here.

- Tap the [Sensor] button in the Linkage menu to call the setup screen shown below.

[What is a slot?]

Servos are classified by CH, but sensors are classified in units called "slot". There are slots from No. 1 to No. 31.

Altitude sensors, GPS sensors and other data sensor units may use multiple slots.

When using a sensor which uses two or more slots, the required number of slots is automatically assigned by setting up a start slot.

When 2 or more of the same kind of sensor are used, the sensors themselves must allocate unused slots and memorize that slot.

Sensor		New-1	7.9V		1/3
Sensor type		Condit1	Sensor type		ID
	ID				
1	Temperature	0	7	Voltage	
2	rpm sensor	0	8	GPS	0
3	Altitude	0	9	GPS	
4	Altitude		10	GPS	
5	Altitude		11	GPS	
6	Voltage	0	12	GPS	

Sensor		New-1	7.9V		2/3
Sensor type		Condit1	Sensor type		ID
	ID				
13	GPS		19	-----	
14	GPS		20	-----	
15	GPS		21	-----	
16	-----		22	-----	
17	-----		23	-----	
18	-----		24	-----	

Slot Number

Registered sensor

Sensor ID : Multiple usage of sensors of the same type requires an ID be input. Tapping this will allow for manual input, but see the next page about how to perform auto-registration via sensor registration.

Tap the slot to display sensors which can be used for the start slot. Tap to register the sensor.

This is what displays when no sensor is registered in a slot. Tapping the slot and selecting "-----" will erase whatever was registered there, freeing up the slot.

- As shown in the table below, an altimeter requires 3 contiguous slots and a GPS sensor requires 8 contiguous slots. The GPS (SBS-01/02G) start slots are 8, 16, and 24.

< Assignable slot >

*Altimeter, GPS, and other sensors that display a large amount of data require multiple slots.

*Depending on the type of sensor, the slot numbers that can be allocated may be limited.

Sensor	The required number of slots	The number which can be used as a start slot	Selling area
TEMP (SBS-01T/TE)	1 slot	1 ~ 31	Global
RPM (SBS01RM/RO/RB)	1 slot	1 ~ 31	
Airspeed (SBS-01TAS)	1 slot	1 ~ 31	
Voltage (SBS-01V)	2 slots	1, 2, 3, 4, 5, 6, 8, 9, 10, 11, 12, 13, 14, 16, 17, 18, 19, 20, 21, 22, 24, 25, 26, 27, 28, 29, 30	
Altitude (SBS-01/02A)	3 slots	1, 2, 3, 4, 5, 8, 9, 10, 11, 12, 13, 16, 17, 18, 19, 20, 21, 24, 25, 26, 27, 28, 29	
Current (SBS-01C)	3 slots	1, 2, 3, 4, 5, 8, 9, 10, 11, 12, 13, 16, 17, 18, 19, 20, 21, 24, 25, 26, 27, 28, 29	
S.BUS Servo sensor (SBS-01S)	6 slots	1, 2, 8, 9, 10, 16, 17, 18, 24, 25, 26	
GPS (SBS-01/02G)	8 slots	8, 16, 24	
Futaba ESC (MC-980H/A, MC-9130H/A, MC-9200H/A)	8 slots	8, 16, 24	
SBS-01ML	16 slots	8, 16	
EM-100	12 slots	8, 16	O.S. ENGINES
TEMP125-F1713	1 slot	1 ~ 31	Europe
VARIO-F1712	2 slots	1, 2, 3, 4, 5, 6, 8, 9, 10, 11, 12, 13, 14, 16, 17, 18, 19, 20, 21, 22, 24, 25, 26, 27, 28, 29, 30	
VARIO-F1672	2 slots	1, 2, 3, 4, 5, 6, 8, 9, 10, 11, 12, 13, 14, 16, 17, 18, 19, 20, 21, 22, 24, 25, 26, 27, 28, 29, 30	
CURR-F1678	3 slots	1, 2, 3, 4, 5, 8, 9, 10, 11, 12, 13, 16, 17, 18, 19, 20, 21, 24, 25, 26, 27, 28, 29	
GPS-F1675	8 slots	8, 16, 24	
Kontronik ESC	8 slots	8, 16, 24	
Castle TL0	8 slots	8, 16, 24	
JetCat V10	14 slots	1, 2, 3, 4, 5, 6, 7, 8, 9, 10, 11, 12, 13, 14, 15, 16, 17, 18	
PowerBox	16 slots	8, 16	

Sensor : Reload

This page is set when using multiple telemetry sensors of the same type.

When using multiple sensors of the same type the sensors must be registered in the transmitter. Connect all the sensors to be used to the T16IZ SUPER as shown in the figure at the right and register them by the following procedure. The ID of each sensor is registered in the transmitter.

- Call page 3/3 from the [Sensor] menu.

•Return to Linkage menu →

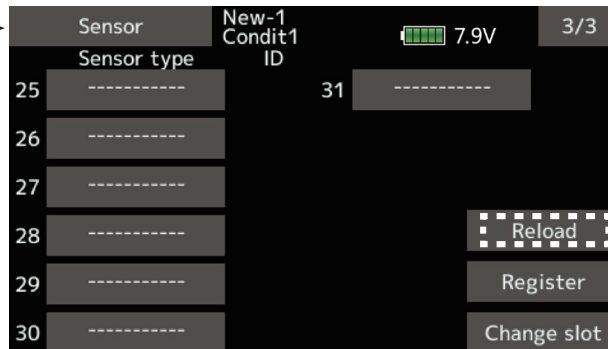

Reading all the sensors to be used

1. Connect the sensor to the T16IZ SUPER as shown in the figure above.
 2. Tap "Reload" on page 3/3 of the [Sensor] screen.
 3. Tap "Reload".
- All the sensors are registered and can be used.

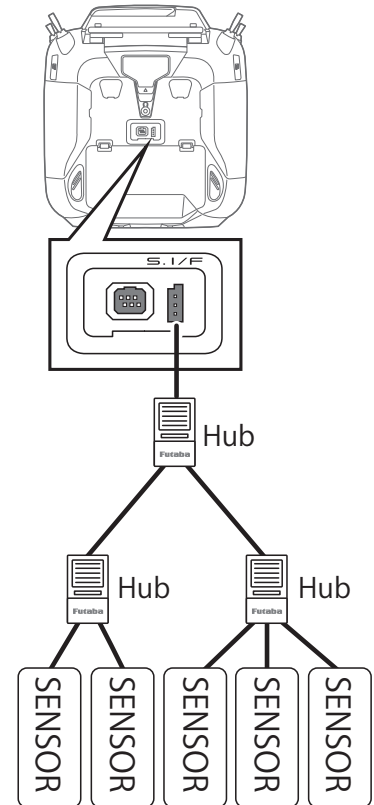

*It is not necessary to carry out multiple battery connections like a T18MZ/T14SG.

Sensor : Register

This page is set when using multiple telemetry sensors of the same type.

This function registers an additional sensor. Connect the sensor as shown in the figure at the right and register it by the following procedure. The sensor ID is registered in the transmitter.

- Call page 3/3 from the [Sensor] menu.

•Return to Linkage menu →

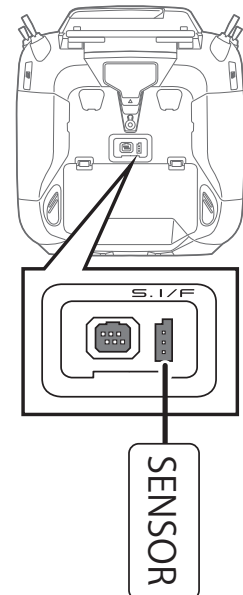

Additional sensor registration

1. Connect the sensor to the T16IZ SUPER as shown in the figure above.
2. Tap "Register" on page 3/3 of the <Sensor> screen.
3. The sensor is registered and can be used.

*When the number of slots needed in registration is insufficient, an error is displayed and registration cannot be performed. Disable unused slots or perform the following reload.

Sensor : Change slot

This page is set when using multiple telemetry sensors of the same type.

This procedure changes the slot number of one registered sensor.

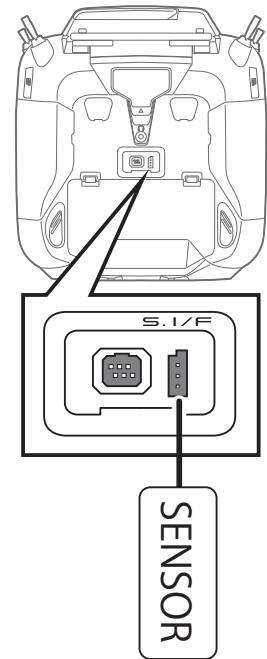

- Call page 3/3 from the [Sensor] menu.

- Return to Linkage menu →

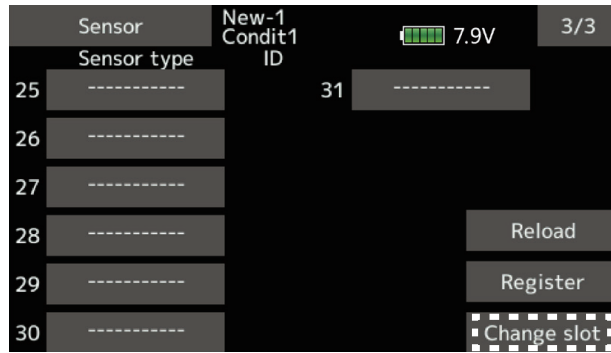

- Tap the [Change slot] button in the Sensor screen to call the setup screen shown below.

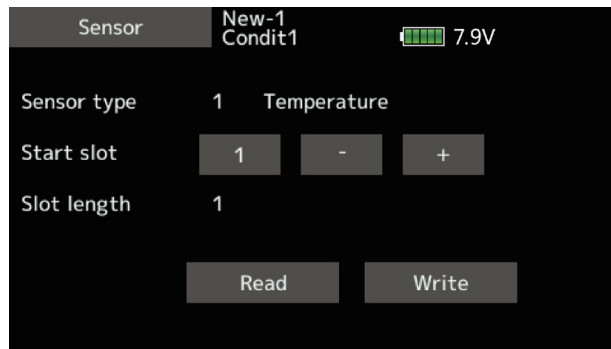

*For some transmitters (e.g., T6K), when the start slot of a sensor is changed, the sensor cannot be used.

Sensor slot change

1. Connect the sensor to the T16IZ SUPER as shown in the figure above.
2. Tap "Change slot" on page 3/3 of the <Sensor> screen.
3. Tap "Read".
4. A sensor details screen appears.
5. The current start slot is displayed. To change a start slot, a + - button, tap. (Cannot be set to a slot that cannot be allocated like the table of all pages.)
6. Tap to the "Write".

WARNING

Do not disconnect or turn transmitter power OFF while telemetry sensor data is being saved.

- Sensor save data will be lost, resulting in malfunction.

Telemetry

Displaying data from the receiver

This screen displays your choice of data from the receiver.

Also warnings can be activated regarding the data. For example, if the receiver voltage drops, the user can be warned by an alarm (and vibration).

- Tap the [Telemetry] button in the Linkage menu to call the setup screen shown below.

•Return to Linkage menu

Start slot number

Tap page button to advance to next page. (The number of pages changes with the number of sensor registration.)

Various telemetry data

Choose the desired sensor and tap.

Max. and min. values since the power was turned ON will display.

Display Sensors

Default display sensors can only be used by connecting the sensors to the receiver. For display of other sensors or to use the same type of sensor in multiple cases, either register them via the "Sensor" option on the Linkage menu or allocate the sensors to empty slots to have them display on the Telemetry screen. Refer to the previous "Sensor" explanation pages for how to do this.

Telemetry: Receiver [Battery]

Displaying data from the receiver battery voltage

In this screen, the battery voltage of a receiver is displayed.

If it becomes higher or lower than the setting, an alarm and/or vibration will alert you.

*It cannot be used in FASST mode and S-FHSS mode.

*Only receiver voltage and EXT voltage can be used in FASSTest12CH mode.

*The FASSTest18CH /T-FHSS mode can use all the telemetry functions.

- Tap the [Receiver] button in the Telemetry screen to call the setup screen shown below.

•Return to Linkage menu →

Receiver New-1 Condit1 7.9V

Battery 6.3V/ 6.3V 6.3V

Ext. battery 0.0V/ 0.0V 0.0V

Receiver battery voltage

Max. and min. values since the power was turned ON will display.

↓ The "down" arrow will indicate that an alarm will sound when the voltage drops to below the setting.

Alarm Inhibit Vibrator Inhibit Limit 4.0V

Speech OFF

Sets the voltage on which the alarm operates.

Alarm is chosen from Buzzer, Voice, and Inhibit.

Allows Speech to be turned ON or OFF.

Alarm set

1. Tap Alarm and choose from Buzzer, Voice, and Inhibit.
2. Choose "Inhibit" for Vibrator if not using the vibrator alarm. If using vibrator, choose one of the three types.
3. Tap to the Limit [4.0 V] item.
4. Adjust the rate using the "▼▼" "▼" "▲" "▲▲" buttons.
Initial value: 4.0 V
Adjustment range: 0.0 V~100.0 V
*When the screen is tapped for one second, the rate is reset to the initial value.
5. To terminate the input and return to the original state, push the HOME/EXIT button.

"Vibrator" type

If the following types are selected, the transmitter will vibrate during the warning.

Type 1 →

Type 2 → →

Type 3 → → → →

Telemetry: Receiver [Ext. battery]

Displaying data from the EXT battery voltage port

The EXT-VOLT screen will display the data from the EXT-battery output from the R7208SB or R7308SB receiver. In order to use this function, it is necessary to connect external voltage connector of the R7208SB or R7308SB receiver to a CA-RVIN-700 or SBS-01V to the battery you desire to measure the voltage of the EXT-battery.

*CA-RVIN-700 must be installed in the aircraft.

You will be alerted by an alarm or vibration if the voltage set by you is exceeded.

*It cannot be used in FASST mode and S-FHSS mode.

*Only receiver voltage and EXT voltage can be used in FASSTest12CH mode.

*The FASSTest18CH /T-FHSS mode can use all the telemetry functions.

- Tap the [Receiver] button in the Telemetry screen to call the setup screen shown below.

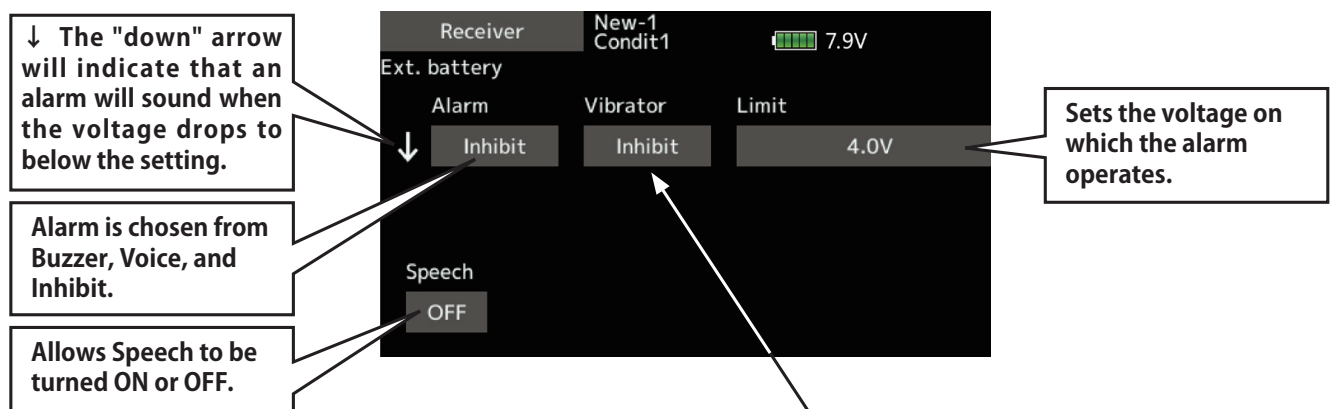
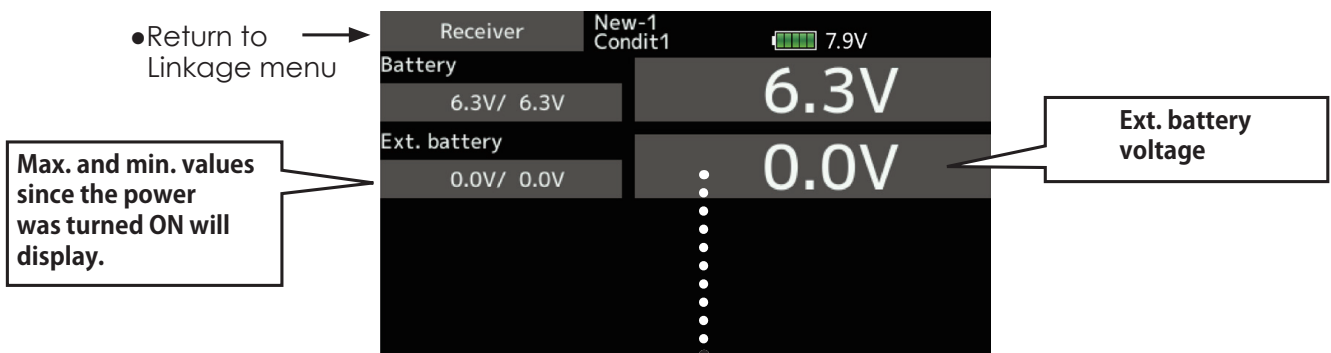

Alarm set

1. Tap Alarm and choose from Buzzer, Voice, and Inhibit.
2. Choose "Inhibit" for Vibrator if not using the vibrator alarm. If using vibrator, choose one of the three types.
3. Tap to the Limit [4.0 V] item.
4. Adjust the rate using the "▼▼" "▼" "▲" "▲▲" buttons.
Initial value: 4.0 V
Adjustment range: 0.0 V~100.0 V
*When the screen is tapped for one second, the rate is reset to the initial value.
5. To terminate the input and return to the original state, push the HOME/EXIT button.

"Vibrator" type

If the following types are selected, the transmitter will vibrate during the warning.

Type 1 →

Type 2 →

Type 3 →

Telemetry : Temperature

Displaying data from the temperature

*A temperature sensor must be installed in the aircraft.

Temperature is a screen which displays/sets up the temperature information from an optional temperature sensor.

The temperature of the model (engine, motor, battery, etc.) which is flying can be displayed.

If it becomes higher or lower than the setting, an alarm and/or vibration will alert you.

*It cannot be used in FASST mode and S-FHSS mode.

*Only receiver voltage and EXT voltage can be used in FASSTest12CH mode.

*The FASSTest18CH /T-FHSS mode can use all the telemetry functions.

- Tap the [Temperature] button in the Telemetry screen to call the setup screen shown below.

•Return to Linkage menu

Temperature 23°C/ 25°C

Temperature 24°C

Max. and min. values since the power was turned ON will display.

↑ An upward arrow will show that an alarm will sound when the temperature rises above the set value.

↓ A downward arrow will show that an alarm will sound when the temperature drops below the set value.

Alarm is chosen from Buzzer, Voice, and Inhibit.

Allows Speech to be turned ON or OFF.

Sets the temperature on which the alarm operates.

Alert set : Temperature warning

1. Tap Alarm and choose from Buzzer, Voice, and Inhibit.
2. Choose "Inhibit" for Vibrator if not using the vibrator alarm. If using vibrator, choose one of the three types.
3. Tap to the Limit [°C] item.
4. Adjust the rate using the "▼▼" "▼" "▲" "▲▲" buttons.

Initial value: ↑100°C ↓0°C

Adjustment range: -20°C ~200°C

(↑Limit ≥ ↓Limit)

*When the screen is tapped for one second, the rate is reset to the initial value.

5. To terminate the input and return to the original state, push the HOME/EXIT button.

"Vibrator" type

If the following types are selected, the transmitter will vibrate during the warning.

Type 1

Type 2

Type 3

Telemetry : RPM Sensor

The RPM Sensor screen is used to set up an optional rpm sensor and display the rotation information it transmits.

The rotation of the model (engine, motor, etc.) which is flying can be shown.

If it becomes higher or lower than the setting, an alarm and/or vibration will alert you.

Displaying data from the rpm

*An rpm sensor must be installed in the aircraft.

*It cannot be used in FASST mode and S-FHSS mode.

*Only receiver voltage and EXT voltage can be used in FASSTest12CH mode.

*The FASSTest18CH /T-FHSS mode can use all the telemetry functions.

- Tap the [rpm sensor] button in the Telemetry screen to call the setup screen shown below.

Return to Linkage menu

Max. and min. values since the power was turned ON will display.

↑ An upward arrow will show that an alarm will sound when the rpm rises above the set value.

↓ A downward arrow will show that an alarm will sound when the rpm falls below the set value.

Alarm is chosen from Buzzer, Voice, and Inhibit.

Allows Speech to be turned ON or OFF.

Sets the rpm on which the alarm operates.

"Magnet"	SBS-01RM →	Gear ratio	1.00~99.00
"Optics"	SBS-01RO →	Blade	2~10
"Brushless motor"	SBS-01RB →	Pole	2~30

Alarm set : Over (Under) rotations

1. Tap Alarm and choose from Buzzer, Voice, and Inhibit.
2. Choose "Inhibit" for Vibrator if not using the vibrator alarm. If using vibrator, choose one of the three types.
3. Tap to the Limit [xxx rpm] item.
4. Adjust the rate using the "▼▼" "▼" "▲" "▲▲" buttons.
Initial value: ↑ 2,000 rpm ↓ 0 rpm
Adjustment range: 0 rpm~150,000 rpm
(↑Limit ≥ ↓Limit)

*When the screen is tapped for one second, the rate is reset to the initial value.

5. To terminate the input and return to the original state, push the HOME/EXIT button.

"Vibrator" type

If the following types are selected, the transmitter will vibrate during the warning.

Type 1

Type 2

Type 3

Telemetry : Altitude

Displaying data from the altitude

*An altitude sensor or GPS sensor must be installed in the aircraft.

Altitude is a screen which displays / sets up the altitude information from an optional altitude sensor or GPS sensor. The altitude of the model which is flying can be known. If it becomes higher (low) than preset altitude, you can be told by alarm. Warning by vibration can also be chosen. Data when a power supply is turned on shall be 0 m, and it displays the altitude which changed from there. Even if the altitude of an airfield is high, that shall be 0 m and the altitude difference from an airfield is displayed. This sensor calculates the

altitude from atmospheric pressure. Atmospheric pressure will get lower as you go up in altitude. Using this, the sensor will estimate the altitude. Please understand that an exact advanced display cannot be performed if atmospheric pressure changes in a weather situation.

*It cannot be used in FASST mode and S-FHSS mode.

*Only receiver voltage and EXT voltage can be used in FASSTest12CH mode.

*The FASSTest18CH /T-FHSS mode can use all the telemetry functions.

- Tap the [Altitude] button in the Telemetry screen to call the setup screen shown below.

Return to Linkage menu

Max. and min. values since the power was turned ON will display.

↑ An upward arrow indicates the alarm will sound when the altitude reaches above your set value.

↓ A downward arrow indicates the alarm will sound when the altitude reaches below your set value.

Alarm is chosen from Buzzer, Voice, and Inhibit.

Allows Speech to be turned ON or OFF.

Allows Melody to be turned ON or OFF.

Sets the altitude on which the alarm operates.

If this is set to Mode1-4, a rise and dive are told by a different melody.

Mode1: Little rise/dive → Melody changes : sensitively

Mode4: Big rise/dive → Melody changes : insensible



First, the set of a reference is required.

1. The model and transmitter to which the altitude sensor was connected are turned on.
2. Tap to the [Preset] of "Reference" item.

*Atmospheric pressure is changed according to the weather also at the same airfield. You should preset before a flight.

"Vibrator" type

If the following types are selected, the transmitter will vibrate during the warning.

- Type 1  →
- Type 2  → →
- Type 3  → → → →

Alarm set : Altitude

1. Tap Alarm and choose from Buzzer, Voice, and Inhibit.
2. Choose "Inhibit" for Vibrator if not using the vibrator alarm. If using vibrator, choose one of the three types.
3. Tap to the Limit [xxx m] item.
4. Adjust the rate using the "▼▼" "▼" "▲" "▲▲" buttons.
Initial value: ↑200 m ↓-50 m
Adjustment range -500 m~+3,000 m (↑Limit ≥ ↓Limit)
*When the screen is tapped for one second, the rate is reset to the initial value.
5. To terminate the input and return to the original state, push the HOME/EXIT button.

Telemetry : Altitude [Variometer]

Displaying data from the variometer

*An altitude sensor or GPS sensor must be installed in the aircraft.

VARIO is a screen which displays / sets up the variometer information from an optional altitude sensor or GPS sensor.

The variometer of the model which is flying can be known.

If it becomes higher or lower than the setting, an alarm and/or vibration will alert you.

To ensure that the pilot is aware as to the model's

status, the T16IZ SUPER incorporates a different melody for ascent and descent. Additionally, depending upon the rate of climb or descent, the tones vary to indicate whether or not the airplane is climbing or descending at a rapid rate.

*It cannot be used in FASST mode and S-FHSS mode.

*Only receiver voltage and EXT voltage can be used in FASSTest12CH mode.

*The FASSTest18CH /T-FHSS mode can use all the telemetry functions.

- Tap the [Variometer] button in the Telemetry screen to call the setup screen shown below.

Return to Linkage menu

Max. and min. values since the power was turned ON will display.

↑ An upward arrow indicates the alarm will sound when the variometer reaches above your set value.

↓ A downward arrow indicates the alarm will sound when the variometer reaches below your set value.

Alarm is chosen from Buzzer, Voice, and Inhibit.

Allows Speech to be turned ON or OFF.

Allows Melody to be turned ON or OFF.

Sets the variometer on which the alarm operates.

Variometer

● If this is set to Mode 1-4, a rise and dive are told by a different melody.

Mode 1 : Little rise/dive → Melody changes : sensitively

Mode 4 : Big rise/dive → Melody changes : insensibly

First, the set of a reference is required.

1. The model and transmitter to which the altitude sensor was connected are turned on.
2. Tap to the [Preset] of "Reference" item.

*Atmospheric pressure is changed according to the weather also at the same airfield. You should preset before a flight.

"Vibrator" type

If the following types are selected, the transmitter will vibrate during the warning.

Type 1

Type 2

Type 3

Alert set : variometer

1. Tap Alarm and choose from Buzzer, Voice, and Inhibit.
2. Choose "Inhibit" for Vibrator if not using the vibrator alarm. If using vibrator, choose one of the three types.
3. Tap to the Limit [m/s] item.
4. Adjust the rate using the "▼▼" "▼" "▲" "▲▲" buttons.
Initial value: +1m
Adjustment range -50 m/s~+50 m/s
(↑Limit ≧ ↓Limit)
*When the screen is tapped for one second, the rate is reset to the initial value.
5. To terminate the input and return to the original state, push the HOME/EXIT button.

Vario Melody Setting

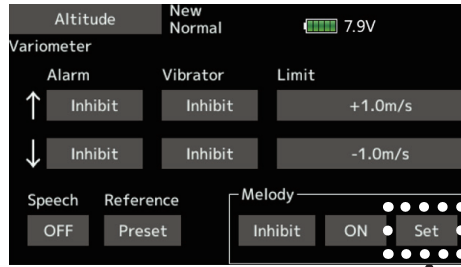

Tap the [Set] button

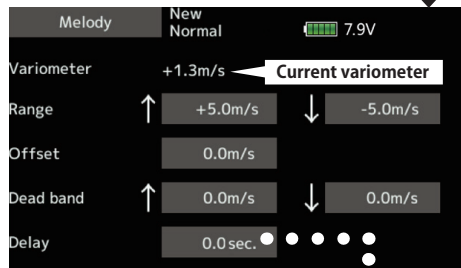

*These settings can be made for each sensor.

Range

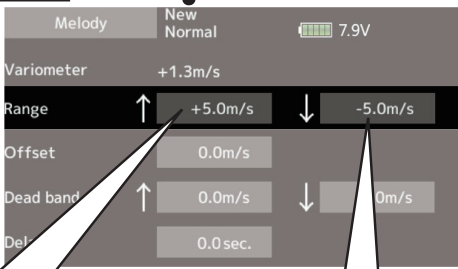

When the variometer is greater than this value, Vario melody is not variable.
Setting range :
 Offset value ~ +50 m/s
Initial value : 5.0 m/s

When the variometer is less than this value, Vario melody is not variable.
Setting range :
 -50 m/s ~ Offset value
Initial value : -5.0 m/s

Deadband

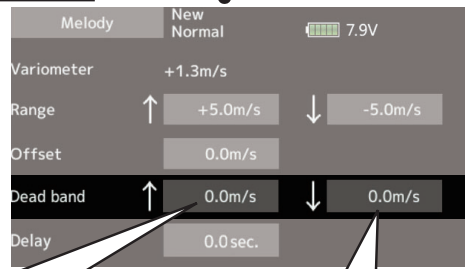

When the variometer is less than this value, Vario melody is not output.
Setting range :
 0 m/s ~ +50 m/s
Initial value : 0.0 m/s

When the variometer is greater than this value, Vario melody is not output.
Setting range :
 -50 m/s ~ 0 m/s
Initial value : 0.0 m/s

Offset



This is the changing point of climb and sink. When the variometer is greater than this value, Vario Melody is climb type. When the variometer is less than this value, Vario Melody is sink type.
Setting range : Range ↑ setting value ~ Range ↓ setting value
Initial value : 0.0 m/s

[The relation of Vario Melody settings]

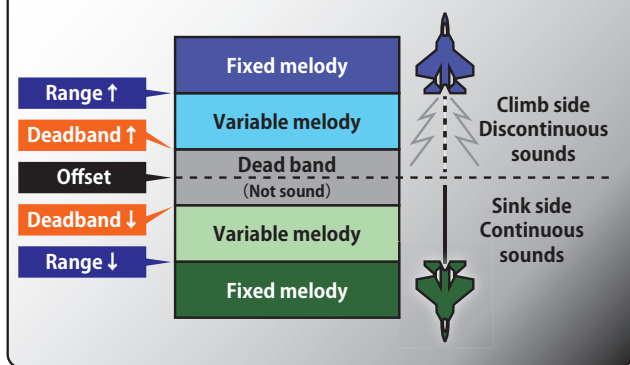

Delay



The output vario melody does not change during the delay time. In other words, this is a minimum time of Vario melody output.

Setting range : 0.0 s, 0.5 s, 1.0 s, 1.5 s
Initial value : 0.0 s

*This parameter is effective to all variometers.

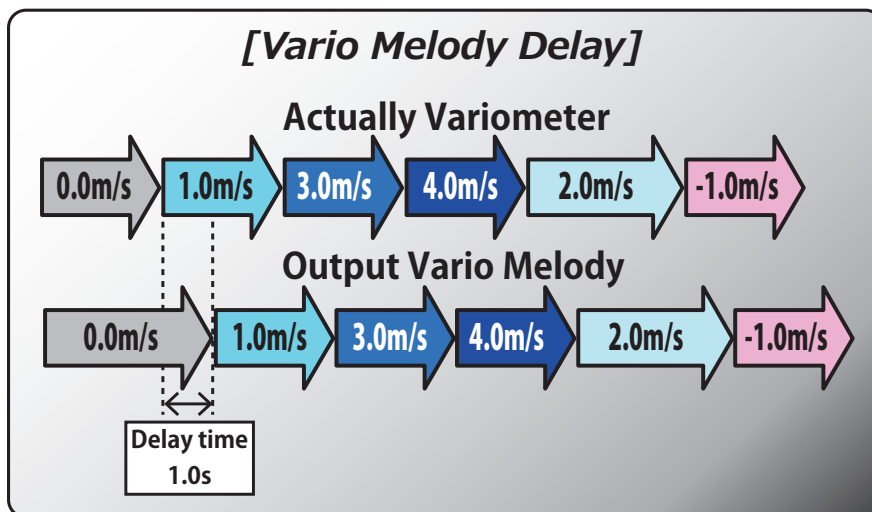

Telemetry: Voltage [Battery]

In this screen, the battery voltage is displayed. In order to use this function, it is necessary to connect External voltage connector of R7208SB (R7308SB) ↔ SBS-01V ↔ Battery. SBS-01V measures two batteries. The power battery connected to two lines is displayed on EXT-VOLT. The battery for receivers connected to 3P lines is displayed here.

- Tap the [Voltage] button in the Telemetry screen to call the setup screen shown below.

•Return to Linkage menu →

Max. and min. values since the power was turned ON will display.

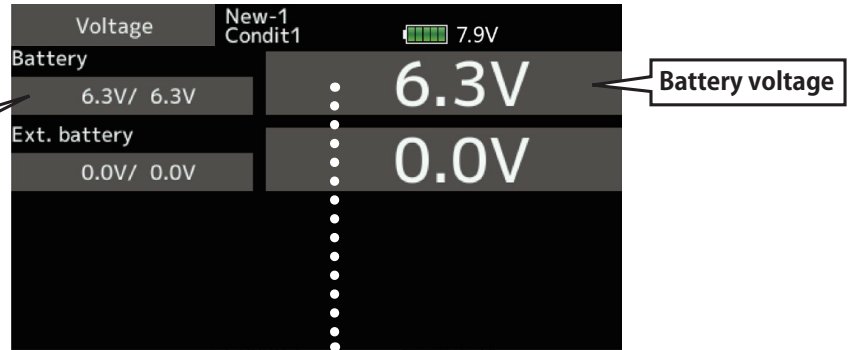

↓ The "down" arrow will indicate that an alarm will sound when the voltage drops to below the setting.

Alarm is chosen from Buzzer, Voice, and Inhibit.

Allows Speech to be turned ON or OFF.

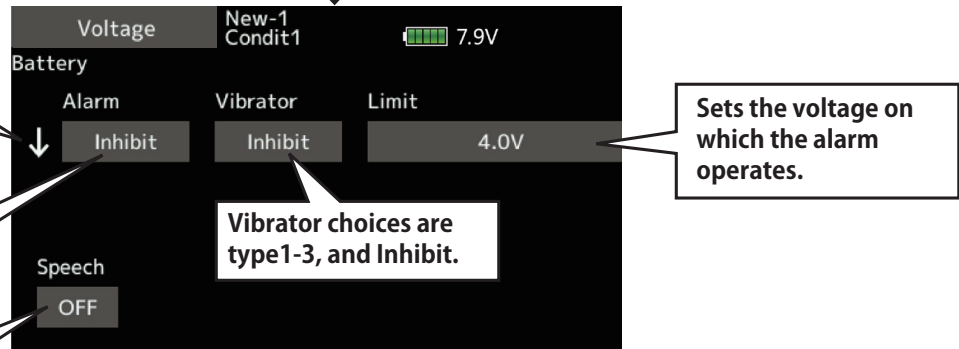

< Two examples of wiring are shown >

Alarm set

1. Tap Alarm and choose from Buzzer, Voice, and Inhibit.
2. Choose "Inhibit" for Vibrator if not using the vibrator alarm. If using vibrator, choose one of the three types.
3. Tap to the Limit [4.0 V] item.
4. Adjust the rate using the "▼▼" "▼" "▲" "▲▲" buttons.

Initial value: 4.0 V

Adjustment range: 0.0 V~100.0 V

*When the screen is tapped for one second, the rate is reset to the initial value.

5. To terminate the input and return to the original state, push the HOME/EXIT button.

*Refer to the manual of SBS-01V for the details of wiring.

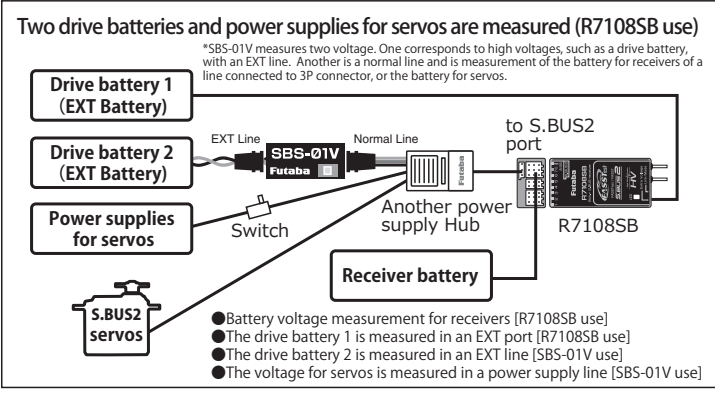
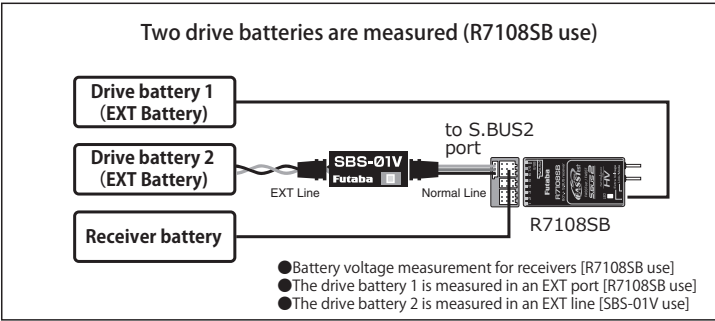

Telemetry: Voltage [Ext. battery]

Displaying data from the EXT battery voltage port

In this screen, the EXT battery voltage is displayed. In order to use this function, it is necessary to connect External voltage connector of R7208SB (R7308SB) ⇔ SBS-01V ⇔ Battery. SBS-01V measures two batteries. The power battery connected to two lines is displayed on EXT-VOLT.

*SBS-01V must be installed in the aircraft.

*It cannot be used in FASST mode and S-FHSS mode.

*Only receiver voltage and EXT voltage can be used in FASSTest12CH mode.

*The FASSTest18CH /T-FHSS mode can use all the telemetry functions.

- Tap the [Voltage] button in the Telemetry screen to call the setup screen shown below.

•Return to Linkage menu →

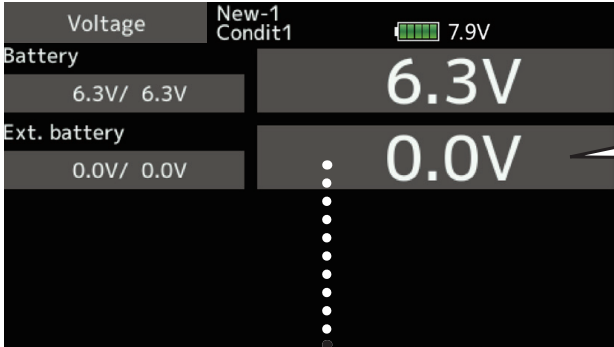

Max. and min. values since the power was turned ON will display.

Ext. battery voltage

↓ The "down" arrow will indicate that an alarm will sound when the voltage drops to below the setting.

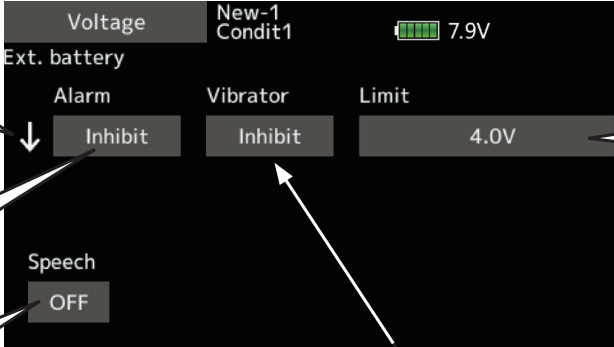

Alarm is chosen from Buzzer, Voice, and Inhibit.

Allows Speech to be turned ON or OFF.

Sets the voltage on which the alarm operates.

Alarm set

1. Tap Alarm and choose from Buzzer, Voice, and Inhibit.
2. Choose "Inhibit" for Vibrator if not using the vibrator alarm. If using vibrator, choose one of the three types.
3. Tap Limit [4.0 V].
4. Adjust the rate using the "▼▼" "▼" "▲" "▲▲" buttons.

Initial value: 4.0 V



Adjustment range: 0.0 V~100.0 V

*When the screen is tapped for one second, the rate is reset to the initial value.

5. To terminate the input and return to the original state, push the HOME/EXIT button.

"Vibrator" type

If the following types are selected, the transmitter will vibrate during the warning.

- Type 1  →
- Type 2  → →
- Type 3  → → → →

Telemetry : GPS [Distance]

The Distance screen displays and sets altitude data from an SBS-01/02G GPS Sensor (sold separately), and allows the distance to the airborne aircraft to be read by the transmitter. When the aircraft flies inside or outside the set distance, an alarm and vibration alerts the pilot.

Displaying data from the Distance Screen

*A GPS sensor must be installed in the aircraft.

*The GPS sensor is necessary, and is sold separately. Mount and connect the sensor in accordance with the sensor instruction manual.

*It cannot be used in FASST mode and S-FHSS mode.

*Only receiver voltage and EXT voltage can be used in FASSTest12CH mode.

*The FASSTest18CH /T-FHSS mode can use all the telemetry functions.

- Tap the [GPS] button in the Telemetry screen to call the setup screen shown below.

•Return to Linkage menu

Max. and min. values since the power was turned ON will display.

↑ An upward arrow indicates the alarm will sound when the distance reaches above your set value.

↓ A downward arrow indicates the alarm will sound when the distance reaches below your set value.

Alarm is chosen from Buzzer, Voice, and Inhibit.

Allows Speech to be turned ON or OFF.

Tap to the [Preset] of "Reference" item. Sets the current aircraft position as the starting point.

Sets the distance on which the alarm operates.

"Vibrator" type

If the following types are selected, the transmitter will vibrate during the warning.

Type 1

Type 2

Type 3

Altitude calculated as either straight line distance (slant) or surface distance on a map can also be selected.

Select <Slant> <Surface> to "Distance mode", tap the screen.

First, the set of a reference is required.

1. The model and transmitter to which the GPS sensor was connected are turned on.
2. Tap to the [Preset] of "Reference" item.

*Now, the position of the present model was set to 0 m.

Setting a "too far" alarm distance

1. Tap Alarm and choose from Buzzer, Voice, and Inhibit.
2. Choose "Inhibit" for Vibrator if not using the vibrator alarm. If using vibrator, choose one of the three types.
3. Tap Limit [m].
4. Adjust the rate using the "▼▼" "▼" "▲" "▲▲" buttons.

Initial value: 1,000 m

Adjustment range 0 m~3,000 m

(↑Limit \cong ↓Limit)

*When the screen is tapped for one second, the rate is reset to the initial value.

5. To terminate the input and return to the original state, push the HOME/EXIT button.

Setting a "too close" alarm distance

1. Tap Alarm and choose from Buzzer, Voice, and Inhibit.
2. Choose "Inhibit" for Vibrator if not using the vibrator alarm. If using vibrator, choose one of the three types.
3. Tap Limit [m].
4. Adjust the rate using the "▼▼" "▼" "▲" "▲▲" buttons.

Initial value: 0 m

Adjustment range 0 m~3,000 m

(↑Limit \cong ↓Limit)

*When the screen is tapped for one second, the rate is reset to the initial value.

5. To terminate the input and return to the original state, push the HOME/EXIT button.

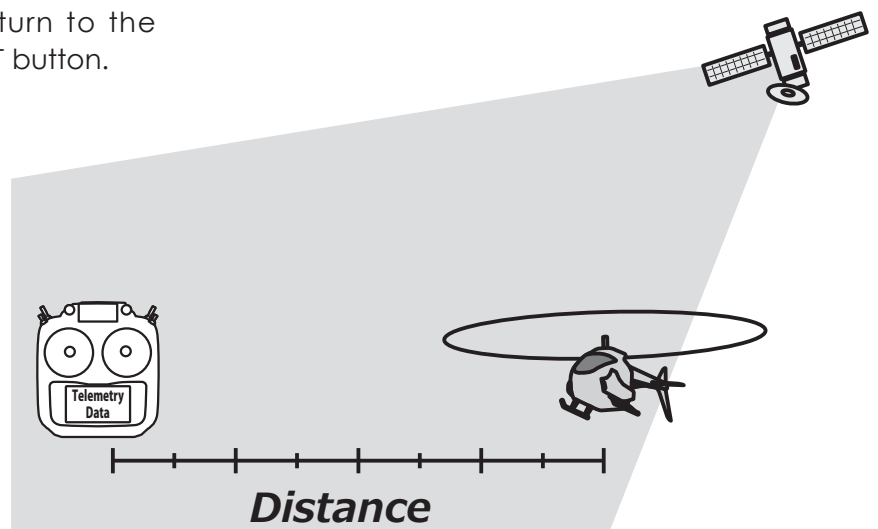

***Positioning time of GPS**

When powered up, the SBS-01/02G begins to acquire GPS satellite data. This process can take several minutes. Please do not move the model during this process. During acquisition, the LED on the SBS-01/02G will blink green; after the satellite's signals have been acquired, the LED will become solid green, and the GPS signal strength display on the transmitter will show three bars.

Moving the model before the satellites are fully acquired will cause a delay in acquiring the satellite signal.

Telemetry : GPS [Speed]

The speed screen displays and sets the speed data from an SBS-01/02G (GPS sensor) sold separately.

The speed of the aircraft during flight can be displayed. After flight, the maximum speed during flight can be viewed. Because this speed is based on position data from a GPS satellite, the ground speed is displayed instead of air speed. Consequently, with a head wind, the displayed speed decreases and with a tail wind, the displayed speed increases.

Displaying data from the speed
*A GPS sensor must be installed in the aircraft.

*The GPS sensor is necessary, and is sold separately. Mount and connect the sensor in accordance with the sensor instruction manual.

*It cannot be used in FASST mode and S-FHSS mode.

*Only receiver voltage and EXT voltage can be used in FASSTest12CH mode.

*The FASSTest18CH /T-FHSS mode can use all the telemetry functions.

- Tap the [GPS] button in the Telemetry screen to call the setup screen shown below.

•Return to Linkage menu →

Max. and min. values since the power was turned ON will display.

↑ An upward arrow indicates the alarm will sound when the speed reaches above your set value.

↓ A downward arrow indicates the alarm will sound when the speed reaches below your set value.

Alarm is chosen from Buzzer, Voice, and Inhibit.

Allows Speech to be turned ON or OFF.

Reference and Distance mode work in conjunction with Distance discussed on the previous two pages.

Sets the speed on which the alarm operates.

Alarm setting when speed increases

1. Tap Alarm and choose from Buzzer, Voice, and Inhibit.
2. Choose "Inhibit" for Vibrator if not using the vibrator alarm. If using vibrator, choose one of the three types.
3. Tap Limit [xxx km/h].
4. Adjust the rate using the "▼▼" "▼" "▲" "▲▲" buttons.
Initial value: ↑200km/h ↓0km/h
Adjustment range 0km/h~500km/h
(↑Limit ≥ ↓Limit)
*When the screen is tapped for one second, the rate is reset to the initial value.
5. To terminate the input and return to the original state, push the HOME/EXIT button.

"Vibrator" type

If the following types are selected, the transmitter will vibrate during the warning.

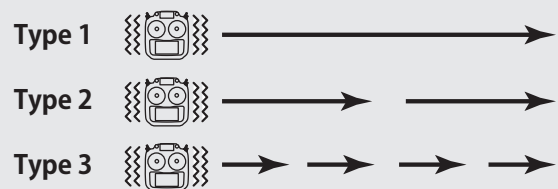

*Speed alarm precaution

Since the GPS speed sensor displays the ground speed, it cannot be used as a stall alarm. For example, an aircraft that stalls at 50km/h will stall if the tailwind is 5km/h or greater even through 55km/h is displayed by ground speed. In addition, with an aircraft that will disintegrate in midflight at 400km/h at an over-speed alarm, when the headwind reaches 30km/h the airplane will disintegrate in midair due to over speeding even at a ground speed of 370km/h.

Telemetry : GPS [Altitude, Variometer, Position]

*A GPS sensor must be installed in the aircraft.

The Altitude, Variometer, Position screen displays and sets the data from an SBS-01/02G (GPS sensor) sold separately.

*It cannot be used in FASST mode and S-FHSS mode.

*Only receiver voltage and EXT voltage can be used in FASSTest12CH mode.

*The FASSTest18CH /T-FHSS mode can use all the telemetry functions.

*The GPS sensor is necessary, and is sold separately. Mount and connect the sensor in accordance with the sensor instruction manual.

- Select [GPS] in the Telemetry screen and access the setup screen shown below.

•Return to Linkage menu

Max. and min. values since the power was turned ON will display.

Refer to the former page for a setup about Altitude and Variometer.

This indicates the receiving accuracy from a GPS Satellite. When three bars are displayed, the GPS is ready for use.

Altitude

Variometer

Position

N 35° 24.7255
E 140° 19.5826

The position of the present model is displayed.

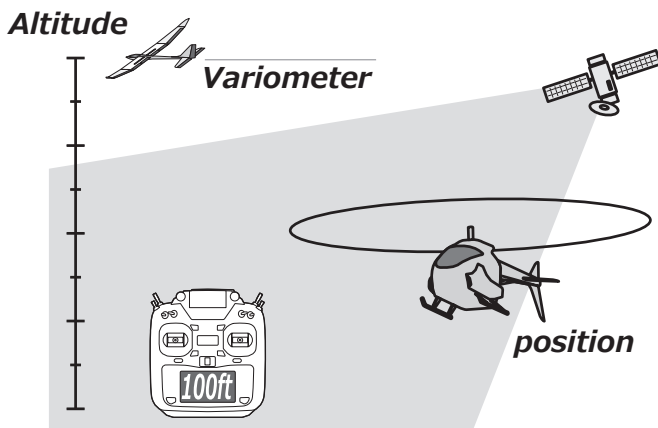

Telemetry : Servo sensor [Current]

The SBS-01S can monitor and display the in-flight current, operating angle, and internal temperature of up to two S.BUS2 servos.

*Servo sensor must be installed in the aircraft.

If you forget to connect the servo wiring during fuselage assembly, or the servo was disconnected, an alarm can be activated at the transmitter.

- Select [Servo sensor] in the Telemetry screen and access the setup screen shown below.

- Return to Linkage menu

Tap here and go to the Servo 2 settings page. (Display and settings content is the same as Servo 1.)

Max. and min. values since the power was turned ON will display.

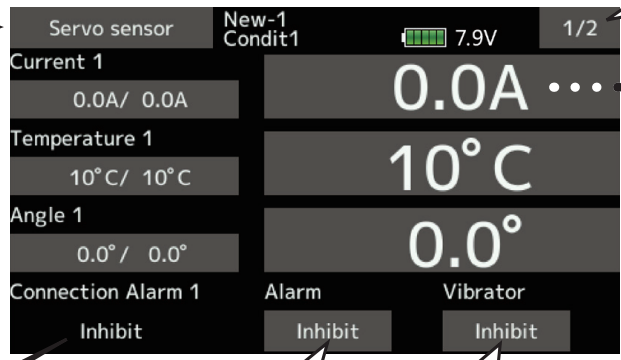

Tapping this will take you to the settings screen for the current alarm

Tapping this and selecting "Buzzer" will cause the device to sound an alarm when servos are not connected.

Tapping this and selecting "Each type" will cause the device to vibrate when servos are not connected.

When the Alarm or Vibrator options are activated, the servo connection will display.

Connection Alarm 1	Connected
Connection Alarm 1	Not Connected

*This alarm and display is limited to the S.BUS servos connected to the servo sensors.

↑ An upward arrow indicates the alarm will sound when the current reaches above your set value.

↓ A downward arrow indicates the alarm will sound when the current reaches below your set value.

Alarm is chosen from Buzzer, Voice, and Inhibit.

Allows Speech to be turned ON or OFF.

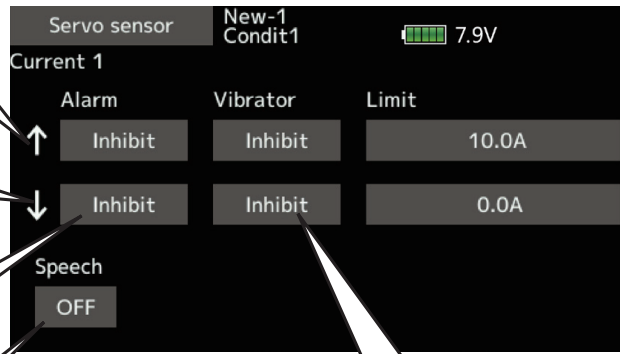

Sets the current on which the alarm operates.

Vibrator is choices are type1-3, and Inhibit.

Initial value: ↑ 10.0A ↓ 0.0A
Adjustment range 0.0A~10.0A
(↑ Limit ≥ ↓ Limit)

Telemetry : Servo sensor [Temperature] [Angle]

*Servo sensor must be installed in the aircraft.

- Select [Servo sensor] in the Telemetry screen and access the setup screen shown below.

•Return to Linkage menu →

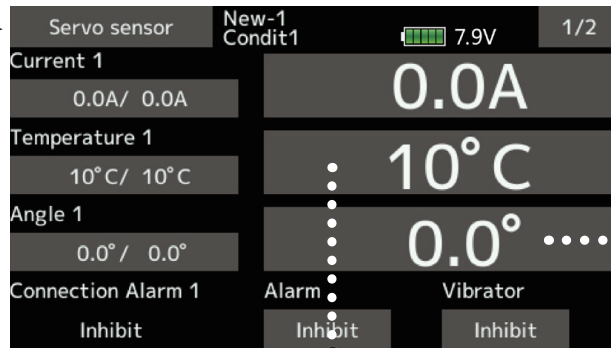

● Temperature

↑ An upward arrow indicates the alarm will sound when the temperature reaches above your set value.

↓ A downward arrow indicates the alarm will sound when the temperature reaches below your set value.

Alarm is chosen from Buzzer, Voice, and Inhibit.

Allows Speech to be turned ON or OFF.

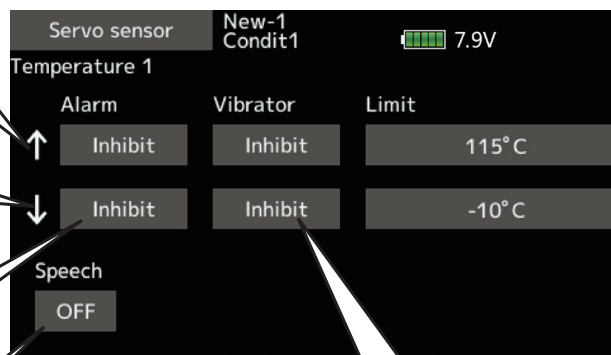

Sets the temperature on which the alarm operates.

Vibrator choices are type1-3, and Inhibit.

Initial value: ↑ 115°C ↓ -10°C
Adjustment range -10°C ~115°C
(↑ Limit ≥ ↓ Limit)

● Angle

↑ An upward arrow indicates the alarm will sound when the angle reaches above your set value.

↓ A downward arrow indicates the alarm will sound when the angle reaches below your set value.

Alarm is chosen from Buzzer, Voice, and Inhibit.

Allows Speech to be turned ON or OFF.



Sets the angle on which the alarm operates.

Vibrator choices are type1-3, and Inhibit.

Initial value: ↑ +180.0° ↓ -180.0°
Adjustment range -180.0° ~ +180.0°
(↑ Limit ≥ ↓ Limit)

Telemetry : Current sensor [Current]

The SBS-01C has the capability of measuring current, voltage and capacity (consumption) from drive battery all at the same time.

*Current sensor must be installed in the aircraft.

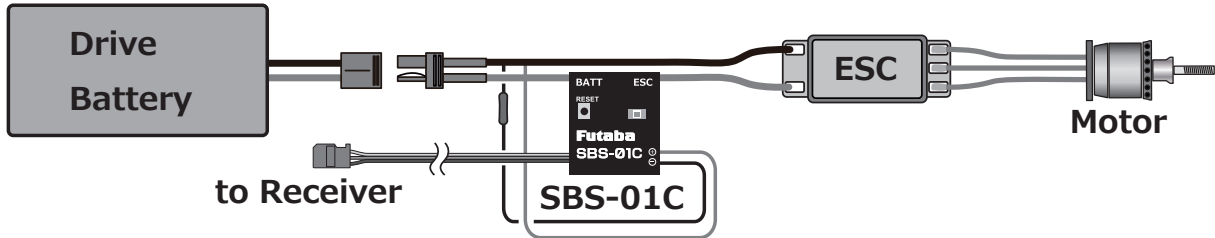

- Select [Current] in the Telemetry screen and access the setup screen shown below.

- Return to Linkage menu

Max. and min. values since the power was turned ON will display.

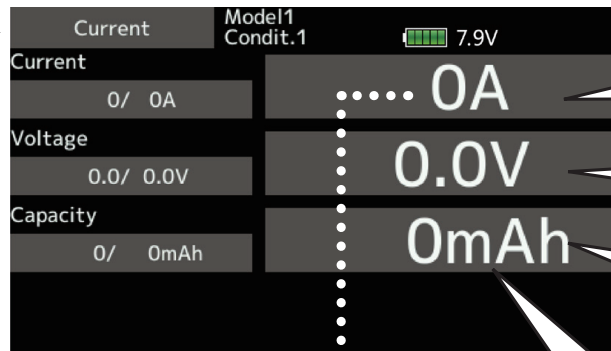

Tapping this will take you to the settings screen for the current alarm

Tapping this will take you to the settings screen for the voltage alarm

Tapping this will take you to the settings screen for the consumption capacity alarm

The consumption capacity is indicated. It isn't the present battery capacity.

◆ Alarm setting

↑ An upward arrow indicates the alarm will sound when the current reaches above your set value.

↓ A downward arrow indicates the alarm will sound when the current reaches below your set value.

Allows Speech to be turned ON or OFF.

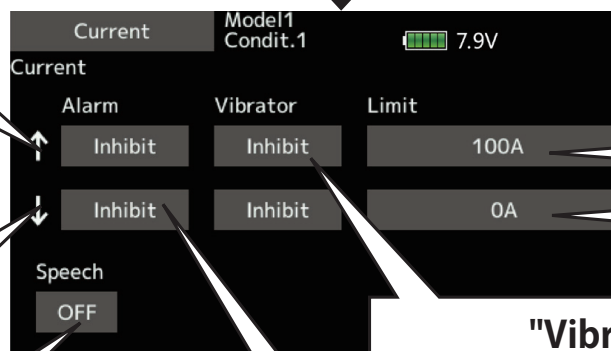

Sets the current on which the alarm operates.

Alarm is chosen from Buzzer, Voice, and Inhibit.

"Vibrator" type

If the following types are selected, the transmitter will vibrate during the warning.

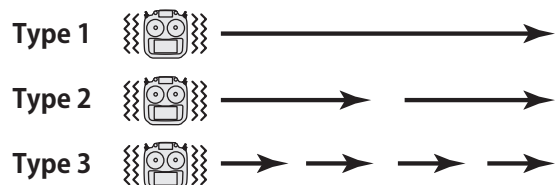

Telemetry : Airspeed sensor [Airspeed]

Displaying data from the airspeed

*A Airspeed sensor must be installed in the aircraft.

The speed screen displays and sets the speed data from an SBS-01TAS (Airspeed sensor) sold separately.

The speed of the aircraft during flight can be displayed. After flight, the maximum speed during flight can be viewed. Airspeed is the speed of an aircraft relative to the air. You will be able to get a more accurate aircraft speed.

- *The Airspeed sensor is necessary, and is sold separately. Mount and connect the sensor in accordance with the sensor instruction manual.
- *It cannot be used in FASST mode and S-FHSS mode.
- *Only receiver voltage and EXT voltage can be used in FASSTest12CH mode.
- *The FASSTest18CH /T-FHSS mode can use all the telemetry functions.

- Tap the [Speed sensor] button in the Telemetry screen to call the setup screen shown below.

•Return to Linkage menu →

Max. and min. values since the power was turned ON will display.

↑ An upward arrow indicates the alarm will sound when the speed reaches above your set value.

↓ A downward arrow indicates the alarm will sound when the speed reaches below your set value.

Alarm is chosen from Buzzer, Voice, and Inhibit.



Allows Speech to be turned ON or OFF.

Sets the speed on which the alarm operates.

Alarm setting when speed increases

1. Tap Alarm and choose from Buzzer, Voice, and Inhibit.
2. Choose "Inhibit" for Vibrator if not using the vibrator alarm. If using vibrator, choose one of the three types.
3. Tap Limit [xxx km/h].
4. Adjust the rate using the "▼▼" "▼" "▲" "▲▲" buttons.
Adjustment range 0km/h~800km/h
(↑Limit ≥ ↓Limit)
*When the screen is tapped for one second, the rate is reset to the initial value.
5. To terminate the input and return to the original state, push the HOME/EXIT button.

If the following types are selected, the transmitter will vibrate during the warning.

- Type 1 
- Type 2 
- Type 3 

Telemetry : Futaba ESC MC-980H/A, MC-9130H/A, MC-9200H/A

*Futaba ESC must be installed in the aircraft.

◆ Register the ESC with transmitter.

Registration to transmitter

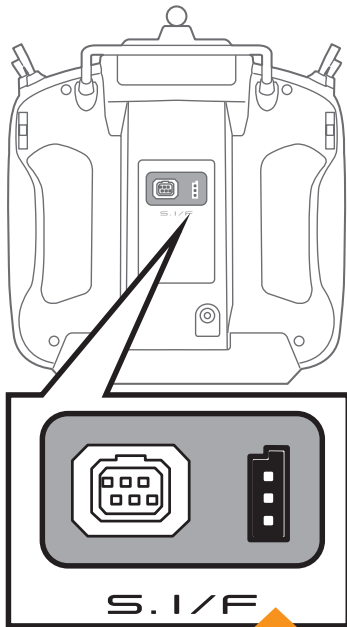

Connect SBM-2 to the S.I / F port on the back of transmitter.

◆ Linkage menu → Sensor → 3/3

- Call page 3 of [Sensor].

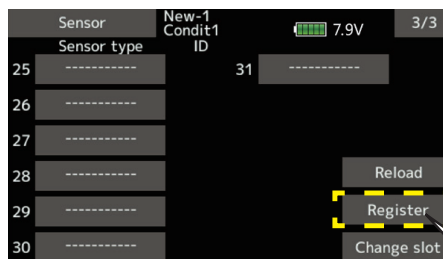

Connect the SBM-2 to the transmitter as shown, then tap Register.

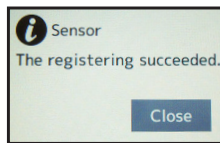

Registration is complete when this screen appears

Complete registration and remove SBM-2 from the transmitter.

*Please note that the proper default slot for this accessory is number 8 (8-15). This sensor uses eight slots. Being made to a start slot are 8, 16, and 24.

◆ The registered ESC will be displayed as "Futaba ESC".

- ◆ The registered Hobbywing ESC is displayed as "Hobbywing ESC".

For details on Hobbywing ESC telemetry support, refer to the Hobbywing website.

◆ MC-9130H / A telemetry connection example

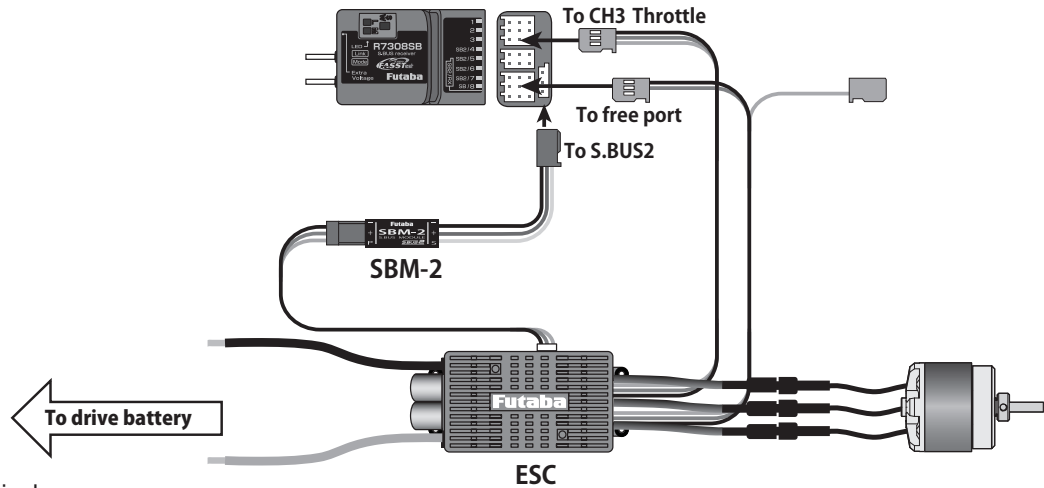

◆ ESC telemetry display screen

The ESC status is displayed. Alarm setting is also possible.

Tap to move to the current setting page.

Tap to move to the voltage setting page.

Tap to move to the capacity setting page.

Tap to move to the rotation setting page.

Tap to move to the temperature setting page.

Display max / min value Press and hold to reset.

Display max / min value Press and hold to reset.

Shows the output level from the ESC to the motor, not the position of the throttle stick. Even if the stick is in the 50% position, the output may not be 50% depending on the ESC setting. Tap to move to the throttle setting page.

Status Throttle not at 0% Low voltage Over temperature Over current Motor locked Throttle signal lost

◆ Alarm setting

↑ An upward arrow indicates the alarm will sound when the current reaches above your set value.

↓ A downward arrow indicates the alarm will sound when the current reaches below your set value.

Allows Speech to be turned ON or OFF.

Alarm is chosen from Buzzer, Voice, and Inhibit.

Sets the current on which the alarm operates.

*The current and capacity consumption display may vary depending on the usage conditions, so use it as a guide.

◆ Alarms can be set for Voltage, Capacity, Rotation, ESC temperature, and Throttle using the same procedure.

Enter the number of poles for your motor.

If the gear is down, enter the gear ratio to display the helicopter rotor speed and the airplane gear down propeller speed.

When enabled, the alarm will be activated in the following warning state.

When enabled, the vibrator will start in the following warning state.

◆ Warning state

Throttle not at 0%	When the throttle stick is not low when ESC is started
Low voltage	When the battery voltage is below the cutoff voltage
Over temperature	When the ESC temperature is 110 ° C or higher
Over current	Peak current over
Motor locked	When the motor locks
Throttle signal lost	When no throttle signal is received for more than 0.25 s

Telemetry : SBS-01ML for Pixhawk®

The SBS-01ML displays telemetry data from the drone flight controller Pixhawk®.

S.BUS Port

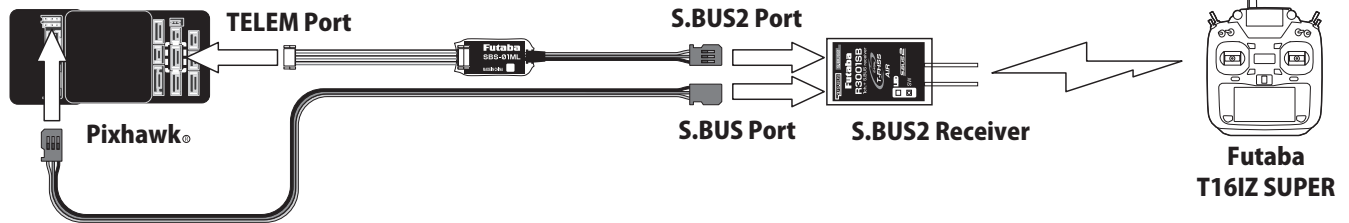

◆ Register SBS-01ML to transmitter by method 1 or 2.

1. Registration to transmitter

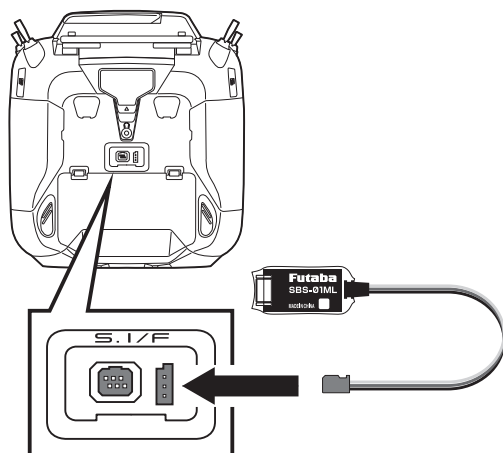

Connect the SBS-01ML to the S.I/F connector on the back of the transmitter.

◆ Linkage menu → Sensor → 3/3

● Call page 3 of [Sensor].

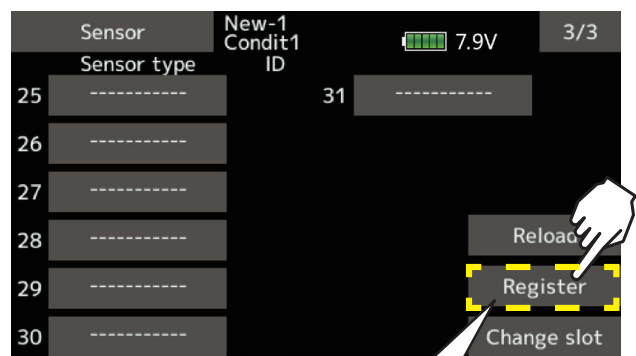

Connect the SBS-01ML to the transmitter as shown, then tap Register.

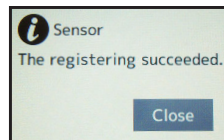

Registration is complete when this screen appears

Complete registration and remove SBS-01ML from the transmitter.

*Please note that the proper default slot for this accessory is number 16 (8-16). This sensor uses eight slots. Being made to a start slot are 8 and 16.

2. Manual registration method

◆ Linkage menu → Sensor

Sensor	New-1 Condit1	7.9V	1/3
Sensor type	ID	Sensor type	ID
1 Temperature	0	7 Voltage	
2 rpm sensor	0	8 GPS	0
3 Altitude	0	9 GPS	
4 Altitude		10 GPS	
5 Altitude		11 GPS	
6 Voltage	0	12 GPS	

Sensor	New-1 Condit1	7.9V	2/3
Sensor type	ID	Sensor type	ID
13 GPS		19	
14 GPS		20	
15 GPS		21	
16		22	
17		23	
		24	

Tap 8 or 16 to display a list of sensors that can be registered. Tap SBS-01ML to register.

Click The default slot for SBS-01ML is #16. When using #8, change the SBS-01ML slot according to the procedure on page 98.

◆ SBS-01ML telemetry display screen

Displays the status of the drone. Alarm setting is also possible.

- Tap the [SBS-01ML] button in the Telemetry screen to call the setup screen shown below.

The image shows three sequential screenshots of the SBS-01ML telemetry display screen, each with a 'Display max / min value Press and hold to reset.' callout on the left and 'Tap to move to the [parameter] setting page.' callouts on the right.

Screen 1 (1/3): Shows GPS status. Parameters include GPS1 Satellites (0/9), GPS1 HDOP (0.0/7.7), GPS2 Satellites (0/0), and GPS2 HDOP (0.0/15.3).

Screen 2 (2/3): Shows flight parameters. Parameters include Altitude (2.9/3.6m), Ground Speed (0.0/0.0km/h), Air speed (0.0/5.5km/h), and Voltage 1 (0.0/7.3V).

Screen 3 (3/3): Shows battery status. Parameters include Current 1 (0.0/0.0A), Voltage 2 (11.5/11.5V), and Current 2 (0.0/0.0A).

*Before connecting, make sure that the telemetry terminal communication speed of the flight controller is set to 57600 bps. (Default is 57600 bps.)

*Pixhawk® 1 and Pixhawk® 2 and later have different connectors, so select a connection cable that matches the connector.

*The data in the table on the right is obtained and displayed using the MAVLink protocol from the flight controller. Devices that do not use these data are not supported.

* Operation with all Pixhawk® flight controllers is not guaranteed.

Item	MAVLink	
	Message	Field
Number of GPS1	GPS_RAW_INT	satellites_visible
GPS1 HDOP	GPS_RAW_INT	eph
Number of GPS2	GPS2_RAW	satellites_visible
GPS2 HDOP	GPS2_RAW	eph
Altitude	GLOBAL_POSITION_INT	relative_alt
Ground speed	VFR_HUD	groundspeed
Air speed	VFR_HUD	airspeed
Voltage 1	BATTERY_STATUS	voltages[0] (id = 0)
Current 1	BATTERY_STATUS	current_battery (id = 0)
Voltage 2	BATTERY_STATUS	voltages[0] (id = 1)
Current 2	BATTERY_STATUS	current_battery (id = 1)

Tele. setting

Speech interval set , data logging of telemetry.

Set the speech interval of telemetry data, and the logging of telemetry data to a microSD card at chosen intervals.

Telemetry data can be checked on your PC after a flight.

- Tap the [Tele.setting] button in the Linkage menu to call the setup screen shown below.

- Return to Linkage menu

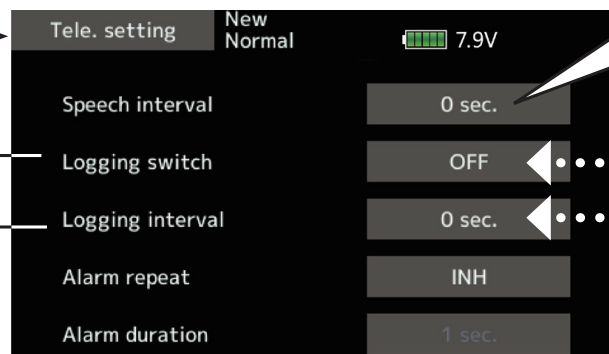

Sets the speech interval
Initial value: 0 sec.
Adjustment range 0-30 sec.

Telemetry data log function

Telemetry data has been adapted to the log function which is recorded at the microSD card.

[Setting method]

- ① Open the linkage menu Tele. setting screen.
 - ② Log recording can be started and stopped by operating a switch. The Logging switch is selected.
 - ③ The log output interval can be set.
- * The data to be recorded is updated at the time set by Linkage menu → System Type screen D/L interval. For example, when the log output interval is 1 second and the D/L interval is 2 seconds the same data is overlapped and recorded twice.

[Operation method]

- ① Insert the microSD card into the card slot.
- ② Set the switch set by Log Start/Stop Switch to ON. A beep sounds and a log file is created and recording of the telemetry data begins.

Absolutely never remove the microSD card while log data is being recorded.

- ③ Set the switch set by Logging switch to OFF. A beeping sound is generated and recording of the telemetry data stops.
- ④ Turn off the transmitter power and remove the microSD card.

■ Log file

A log file is created in the microSD card LOG folder. Two files with the same filename, but a different extension are created. (Example: 00001234.FLI, 00001234.FLD)

■ Extension FLI: Slot allocation information file

■ Extension FLD: Log data file

*When copying or moving a log file, always select both the .FLI file and .FLD file.

Log files can be converted to CSV format by using the telemetry log converter available at the Futaba website.

■ Notes

- ◇ Altimeter altitude data and GPS distance and altitude data output with the point that time logging started as the reference (0 m). When the transmitter preset position and the log start position are different, the transmitter display and the log data display will also be different. The altitude and distance from the take-off position can be recorded by starting logging immediately after take-off.
- ◇ The transmitter gear ratio or number of fins setting is not reflected in the speedometer log data (speed). Multiply the gear ratio or number of fins by the speed data.
- ◇ When the microSD card becomes full, recording stops and does not resume even if logging is restarted.

Telemetry Alarm Duration and Repeat time

The repeat time and duration time for the telemetry alarm (buzzer, vibration and speech) can be set.

- Tap the [Telemetry Setting] button in the Linkage menu to call the setup screen shown below.

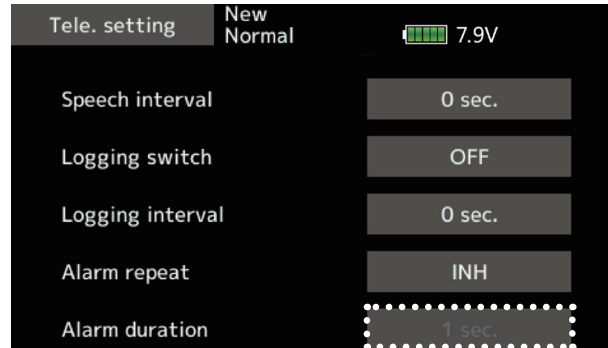

Duration is not displayed when Repeat is **INH**.

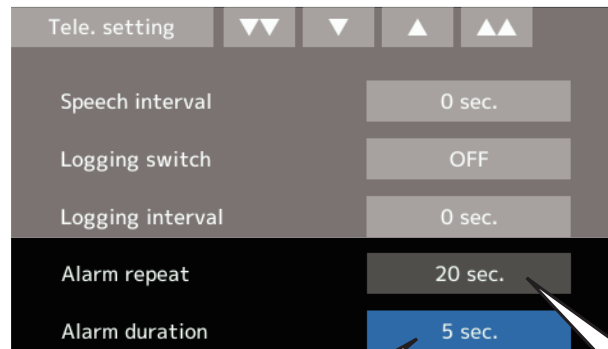

Duration

It is an alarm output time.

Setting range : 1 s ~ 30 s

Initial value : INH

Duration value has to be less than repeat value.

Duration time is extended when the other alarm event occurs.

Repeat

It is a repeat time of an alarm output.

Setting range : INH, 1 s ~ 240 s

Initial value : INH

[Duration and Repeat time for Telemetry Alarm]

e.g. Repeat time is 8 seconds and Duration time is 5 seconds.

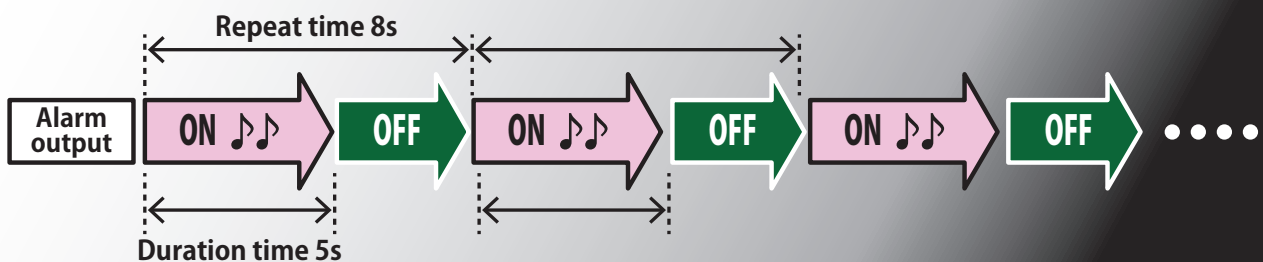

T16IZ SUPER trainer system makes it possible for the instructor to choose which channels and operation modes can be used in the student's transmitter. The function and rate of each channel can be set. The training method can also be matched to the student's skill level. Two transmitters must be connected by an optional Trainer Cord, and the Instructor's transmitter should be programmed for trainer operation, as described below.

When the Instructor activates the trainer switch, the student has control of the aircraft (if MIX/ FUNC/ NORM mode is turned on, the Instructor can make corrections while the student has control). When the switch is released the Instructor regains control. This is very useful if the student gets the aircraft into an undesirable situation.

- Setting data are stored to model data.
- Student rate can be adjusted at MIX/FUNC/ NORM mode.
- Activated student channels can be selected by switches.

Note: This trainer system can be used in the following manner:

1. With the T16IZ SUPER transmitter and a conventional transmitter, if the channel order is different, it is necessary to match the channel order before using this function.

You can select the channel of input data from student's transmitter in the "FUNC" or "MIX" mode.

2. When the T16IZ SUPER is used as the instructor's transmitter, set the modulation mode of the student's transmitter to PPM.

If being used as the student, T16IZ SUPER can be connected to the instructor's transmitter which requires the student's mode to be PPM. T16IZ SUPER always sends PPM mode signal from the trainer jack.

(In the case of student's transmitters other than 2.4 GHz)

3. Be sure that all channels work correctly in both transmitters before flying.

Corresponding types of transmitters and trainer mode settings:

Types of transmitters		Instructor's transmitter settings		Student's transmitter settings			Trainer Cords
Instructor	Student	System Type	Trainer setting	System Type	Trainer setting	Trainer setting	
		Mod. mode	CH mode	Mod. mode	CH mode	Mod. mode	
T16IZ SUPER,FX-32 T14SG,T16IZ,T16SZ, T18SZ,T18MZ, T32MZ	T16IZ SUPER,FX-32 T14SG,T16IZ,T16SZ, T18SZ,T18MZ, T32MZ	Arbitrary	16CH	Arbitrary	16CH	-	T12FG and 9C Trainer Cords
T16IZ SUPER	T14MZ, FX-40, T12Z, T12FG, FX-30	Arbitrary	12CH	PCM-G3 2.4G	12CH	PPM	
T16IZ SUPER	T8FG, FX-20	Arbitrary	12CH 8CH	FASST-MLT2 FASST-MULT	-	-	
T16IZ SUPER	T10C, T9C, T7C,T6EX, T4EX	Arbitrary	8CH	PPM	-	-	T12FG
T16IZ SUPER	T10CG,T7C	Arbitrary	8CH	Arbitrary	-	-	T12FG
T16IZ SUPER	T10J, T8J, T6K, T6J, T6L	Arbitrary	8CH	Arbitrary	-	-	T12FG and 9C Trainer Cords
T14MZ, FX-40, T12Z, T12FG, FX-30	T16IZ SUPER	Arbitrary	12CH	Arbitrary	12CH	-	
T8FG, FX-20	T16IZ SUPER	Arbitrary	12CH	Arbitrary	12CH	-	
T10C, T10CG, T10J, T9C, T7C T7C, T8J, T6K T6J	T16IZ SUPER	Arbitrary	-	Arbitrary	8CH	-	

- Tap the [Trainer] button in the Linkage menu to call the setup screen shown below.

- Return to Linkage menu

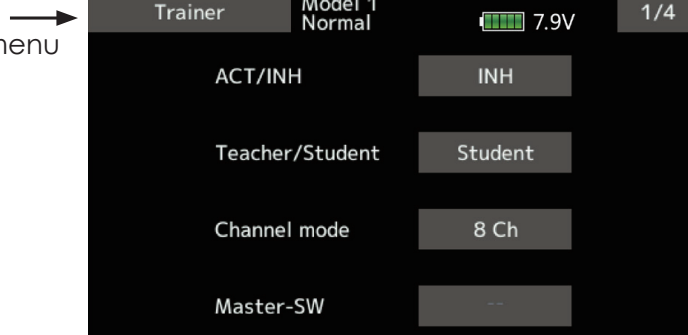

When using at the student side

1. Select the mode.

*When changing the mode, tap to the item you want to change and change the mode using the "▼▼" "▼" "▲" "▲▲" buttons. The display blinks. Tap the screen to change the mode.

"Teacher/Student": Select [Student].

"ACT/INH": Enable operation by changing to [ACT].

"16/12/8 CH": When the student uses the T16IZ SUPER, T14SG, T18SZ, T16IZ, T16SZ, T18MZ, T32MZ select [16CH]. When the student uses the T14MZ, T12Z, T12FG or FX-40, select [12CH]. Otherwise select [8CH].

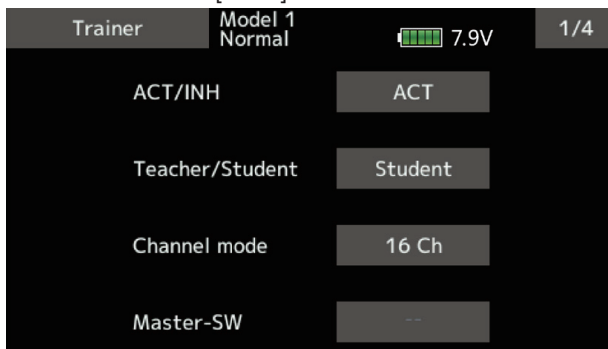

Note: In "student mode", only the teacher side can turn on and off the power to the student's transmitter. Keep the power switch always at off position.

When using at the teacher side

1. Select the mode.

*When changing the mode, tap to the item you want to change and change the mode using the "▼▼" "▼" "▲" "▲▲" buttons. The display blinks. Tap the screen to change the mode.

"Teacher/Student": Select [Teacher].

"ACT/INH": Enable operation by changing to [OFF] or [ON].

"16/12/8 CHANNEL": When the student uses the T16IZ SUPER (including the T18MZ, T32MZ, T14SG) select [16CH]. Otherwise select [12CH] or [8CH].

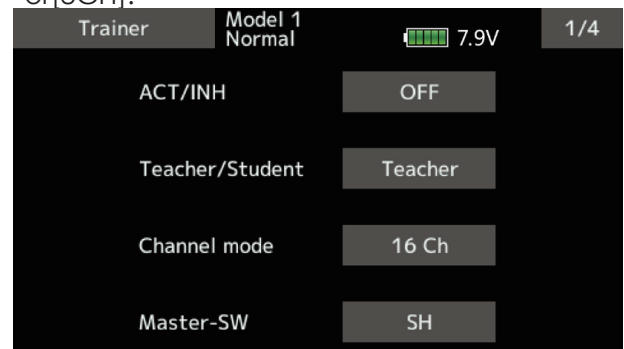

2. Select the trainer switch.

*When setting or changing the switch, tap to the "SWITCH" item, call the switch setup screen and set the desired switch and ON/OFF direction.

(See "Switch selection method" at the end of this manual for selection method details.)

*The switch mode can also be selected when setting the ON position on the switch setup screen. When [Normal] is selected, normal ON/OFF operation is performed. When [Alternate] is selected, the trainer function is alternately turned on and off each time the switch is operated. This allows alternate ON/OFF switching even when a momentary switch (SH) is used.

Note: The trainer function won't be turned on unless the Instructor's transmitter receives signals from the student's transmitter. Be sure to confirm this after connecting your trainer cable.

3. Select the operating mode for each channel.

Trainer	Model 1 Normal	7.9V	2/4		
Ch	Function	Mode	Switch	Rate	Stu.Ch
1	Aileron	FUNC	--	100	Ch 1
2	Elevator	OFF			
3	Throttle	OFF			
4	Rudder	OFF			
5	Gyro	OFF			
6	Pitch	OFF			

"NORM": The model is controlled by signals from the student transmitter.

"MIX" mode: The model is controlled by signals from the teacher and student transmitters. (Reset the student's model data to the default condition.)

"FUNC" mode (function mode):

The model is controlled by signals from the student transmitter with the teacher AFR setting. (Reset the student's model data to the default condition.)

"OFF": Only the teacher side operates.

*The setting above allows setting of the servo throw relative to the amount of student side operation when [MIX] or [FUNC] was selected.

When changing the rate, use the "▼▼" "▼" "▲" "▲▲" button to Tap the [Rate] item of the channel.

Setting range: -100~100

Initial value: 100

*When the value is tapped, the rate is reset to the initial value.

4. Set the switch of each channel.

*When setting the switch at each channel, tap to the "SW" item of the channel you want to change, call the switch setup screen, and select the switch.

"--" : Always ON.

"SA"~"SH": The switch which enables student side operation can be selected. (See "Switch selection method" at the end of this manual for selection method details.)

Trainer	Model 1 Normal	7.9V	2/4		
Ch	Function	Mode	Switch	Rate	Stu.Ch
1	Aileron	FUNC	--	100	Ch 1
2	Elevator	OFF			
3	Throttle	OFF			
4	Rudder	OFF			
5	Gyro	OFF			
6	Pitch	OFF			

Trainer student channel setting function

In training mode, the instructor's transmitter can pick up the student's signal on both the "Function" and "Mix" channels. That makes it easy for the two transmitters to connect even if the student and instructor have set up their transmitters differently.

*When the instructor's transmitter mode is set to "NORM", the signal of the same channel of the student's transmitter is output as is. (The same as before.)

Trainer	Model 1 Normal	7.9V	2/4		
Ch	Function	Mode	Switch	Rate	Stu.Ch
1	Aileron	FUNC	--	100	Ch 1
2	Elevator	OFF			
3	Throttle	OFF			
4	Rudder	OFF			
5	Gyro	OFF			
6	Pitch	OFF			

Trainer connector power supply specification

Trainer connector to supply power to external equipment connected to the trainer connector, when turning on the power by pressing the power switch in the trainer student mode.

! Futaba is not responsible for damage sustained by combination with parts other than Futaba Genuine equipment.

! When connecting Futaba transmitters to the trainer code, do not operate the power switch on the student side transmitter and operate the power switch on the teacher side transmitter as before. The student side transmitter turns power automatically in conjunction with the teacher side.

Warning setting

The warning display at power ON can be turned ON/OFF for each function. Use by setting functions which may be dangerous if operated at power ON to ON. Initial setting is all ON (Buzzer).

- Tap the [Warning setting] button in the Linkage menu to call the setup screen shown below.

- Return to Linkage menu →

Warning setting	Model 1 Normal	Alarm	Vibrator
Condition		Buzzer	Inhibit
Throttle cut		Buzzer	Inhibit
Idle down		Buzzer	Inhibit
Throttle position		Buzzer	Inhibit
Motor		Buzzer	Inhibit
Throttle hold		Buzzer	Inhibit

The settings can be changed individually. When set to [Inhibit], a warning is not displayed at power ON.

"Vibrator" type

If the following types are selected, the transmitter will vibrate during the warning.

Type 1  →

Type 2  → →

Type 3  → → → →

⚠ WARNING

! It is extremely dangerous to unnecessarily inhibit essential warnings.

- Careless spinning of propellers or rotors poses a danger of serious injury or death.

User menu setting

Original menu screen making

T16IZ SUPER has a menu for each of the following: System, Linkage, and Model. Also, you can create a personalized User menu that can include all of the menus that you use most often.

*Any change made to data entered from the User menu or from the normal method of use are the same. Changes made in either way are saved into the transmitter memory.

- Tap the [User menu setting] button in the Linkage menu to call the setup screen shown below.
- Return to Linkage menu

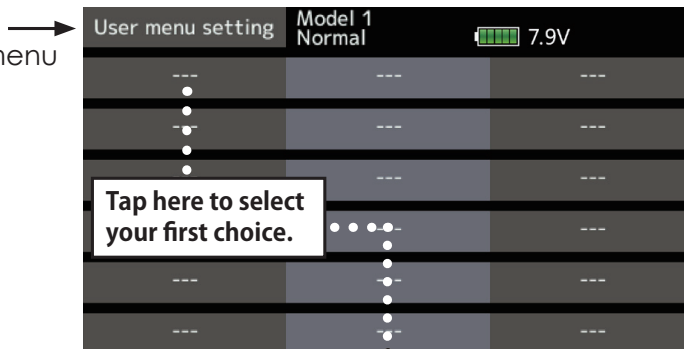

Once pressed, 3 pages of choices will be displayed.

User menu select			Model 1 Normal	7.9V	1/3
Display	Sound volume	Date and Time			
Calibration	Battery	Range check			
S.Bus servo	Information	Servo monitor			
Model select	Model type	Servo reverse			
End point	Servo speed	Sub-trim			
Function	Fail safe	System type			

When "---" is chosen, it can be deleted.

Make your selection, press your choice and the first of your "User menu" will be entered.

How to call a User menu

1. From the home screen, press the U.MENU/MON. button.

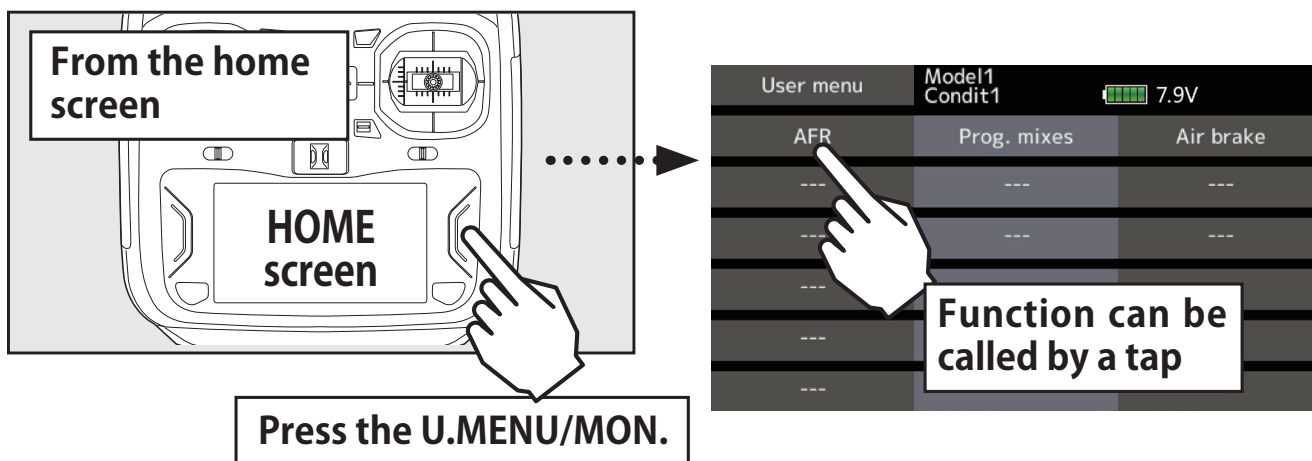

Data reset

Model memory setting data reset. (by item)

This function is designed to allow you to reset selected portions or all of the settings saved in the active model memory. You may individually choose to reset the following sets of data:

Trim (All condition):

Reset the digital trim setting.

*All the conditions, or the condition currently being displayed (the entire group for group setting), can be selected.

*The trim step amount and trim rate are not reset.

Trim (Current and Group condition):

Reset the digital trim setting.

*Current condition, group condition, can be selected.

- Select [Data reset] at the linkage menu and call the setup screen shown below.

- Return to Linkage menu

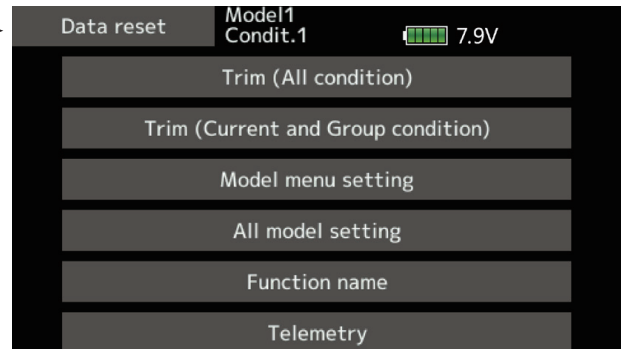

*The trim step amount and trim rate are not reset.

Model menu setting:

Resets all the functions in the Model menu except condition select.

All model setting:

Resets all Linkage and Model menu functions except for system type, model select, model type, function name, and telemetry setting.

Function Name:

A function name is reset.

Telemetry:

Reset the telemetry setting.

Data resetting method

1. Tap to the item you want to reset and tap the screen.

*A confirmation message appears.

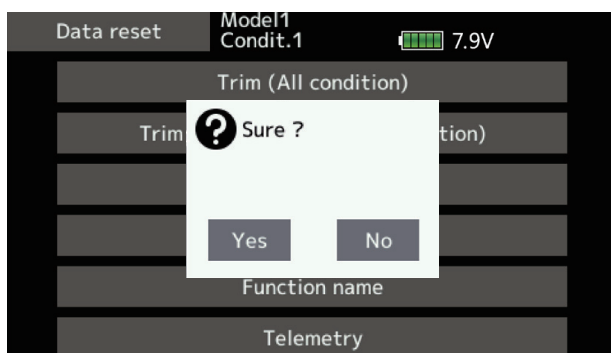

2. Execute reset by tapping the "Yes".

[Trim (All condition)]: Resets only the Trim (all conditions)

[Trim(Current and Group condition)]: Resets only the data of Trim (condition in use and all the conditions set to group mode)

[Model menu setting]: Resets all the functions in the model menu, except the condition selection functions.

[All model setting]: Resets all the functions in the linkage menu and model menu except the frequency, model select, and model type functions.

[Function name]: Resets only the function name functions.

[Telemetry]: Resets only the telemetry functions.

⚠ CAUTION

⊘ **Never engage the Data reset function while the engine is starting or the motor drive wiring is connected.**

■ Sudden, abrupt spinning of propellers or rotors is extremely dangerous.

⚠ CAUTION

⚠ Throttle Reverse

■ Only the throttle channel (CH3) initial setting is REV (reverse). Thoroughly check the Hi and Low directions of the engine or motor used and be careful that they do not suddenly run at full speed. Even after data reset, CH3 is reversed.

MODEL MENU (Airplane/Glider functions)

The dedicated mixes, etc. usable when airplane or glider model type is selected are displayed in this Model menu functions section. First use the Model type function of the Linkage menu to preset the model type, wing type, and tail type matched to the fuselage used. Other settings reset the data used in mixing function, etc.

These dedicated mixes can be set for each flight condition, as required. When you want to use the system by switching the settings for each condition by switch or stick position, use the























Condition select function to add flight conditions. (Up to 8 conditions can be used)

Note: The T16IZ SUPER is designed so that the airplane and glider model types can handle aircraft of the same wing type.

The functions common to airplanes and gliders, except some dedicated functions, are summarized without regard to the model type.

The setting items are different, depending on the number of servos, etc. according to the wing type used. The setup screens in the instruction manual are typical examples.

Model menu (Airplane/Glider) functions table

 Servo monitor	Displays the servo test and operation position	
 Condition select	Flight conditions addition, deletion, copy, condition renaming, and condition delay can be set.	
 AFR	Sets the angle and curve of all the operation functions.	
 Dual rate	D/R curve which can be switched with a switch, etc. can also be added.	
 Program. mixes	Program mixing which can be freely customized. Up to 10 mixes can be used for each condition.	
 Aileron differential	This function adjusts the left and right ailerons. Roll axis correction and fine tuning with a VR are also possible. This is convenient when making settings during flight.	[Airplane/glider, 2 ailerons or more]
 Flap setting	The flaps can be adjusted independently. For a 4 flaps model, the camber flaps can be mixed with the brake flaps.	[Airplane/glider, 2 flaps or more]
 AIL → Camber flap	This mix operates the camber flaps in the aileron mode. It improves the operation characteristic of the roll axis.	[Airplane/glider, 2 ailerons + 2 flaps or more]
 AIL → Brake flap	This mix operates the brake flaps in the aileron mode. It improves the operation characteristic of the roll axis.	[Airplane/glider, 4 flaps or more]
 Aileron → Rudder	This mix is used when you want to operate the rudder at aileron operation. Banking at a shallow bank angle is possible.	[Airplane/glider, general]
 Elevator → Camber	This mix is used when you want to mix camber flaps with elevator operation. Lifting force can be increased at elevators up.	[Airplane/glider, 2 ailerons or more]
 Camber mixing	This mix adjusts the camber and corrects the elevators.	[Airplane/glider, 2 ailerons or more]
 Airbrake → ELE	This mix is used to correct operation of the airbrakes (spoilers) when landing.	[Airplane/glider, general]
 Camber flap → ELE	This mix is used to correct for attitude changes when the camber flaps are being used.	[Airplane/glider, 2 ailerons + 1 flap or more]
 Rudder → Aileron	This function is used to correct roll knife edge, etc. of stunt planes.	[Airplane/glider, general]
 Rudder → Elevator	This function is used to correct roll maneuvers, knife edge, etc. of stunt planes.	[Airplane, general]
 Butterfly (Crow)	This function is used when powerful brake operation is necessary.	[Glider, 2 ailerons or more]
 Trim mix 1/2	The ailerons, elevators, and flaps trim offset rate can be called by switch or condition selection.	[Glider general]
 Snap roll	This function selects the snap roll switch and adjusts the steering angle of each rudder. Servo speed can also be adjusted.	[Airplane general]
 Air brake	This function is used when airbrakes are necessary when landing or when diving, etc. during flight.	[Airplane, general]
 Gyro	This is a dedicated mix when a GYA Series gyro is used.	[Airplane/glider/multicopter, general]
 Ailevator	This function adjusts the elevators and ailerons of models with elevator specifications.	[Airplane/glider, elevator specifications]
 Acceleration	Allows a brief "overload" in response to sudden Elevator, Elevator → Camber, and Ail → Rudder.	[Airplane/glider general]
 Motor	The operation speed when the motor of F5B and other EP gliders is started by switch can be set.	[Airplane/glider, general]
 V-Tail	This function adjusts the elevators and rudder of V-tail models.	[Airplane/glider, V-tail specifications]
 Winglet	This function adjusts the left and right rudders of winglet models.	[Airplane/glider, winglet specifications]
 Gyro Setting	This function Futaba Airplane Gyro GYA553 Settings.	[Airplane, general]

Condition select

Flight condition's addition, deletion, copy, condition renaming, and condition delay can be set. [All model types]

The functions in the Model menu can be used by switching the settings of up to 8 flight conditions by using the Condition select function to add flight conditions. Add conditions, as required.

When you do not want to use the Condition select function, this setting is unnecessary. In this case, use the flight conditions assigned at initial setting.

- Since switching by stick and lever position, in addition to ordinary toggle switch, is possible as the flight condition selector switch, this function can be linked with other operations.
- A Condition Delay function can be set. Unnecessary fuselage motion generated when there are sudden changes in the servo

positions and when there are variations in the operating time between channels during condition switching can be suppressed. The delay can be set for each channel.

When setting the delay function at the switching destination condition, the related function changes after a delay corresponding to the set amount.

- When multiple conditions were set, their operation priority can be freely changed.
- The condition name can be changed. The selected condition name is displayed on the screen. When a condition has been added, give it a name which can be easily confirmed.

- Select [Condition select] at the model menu and call the setup screen shown below.

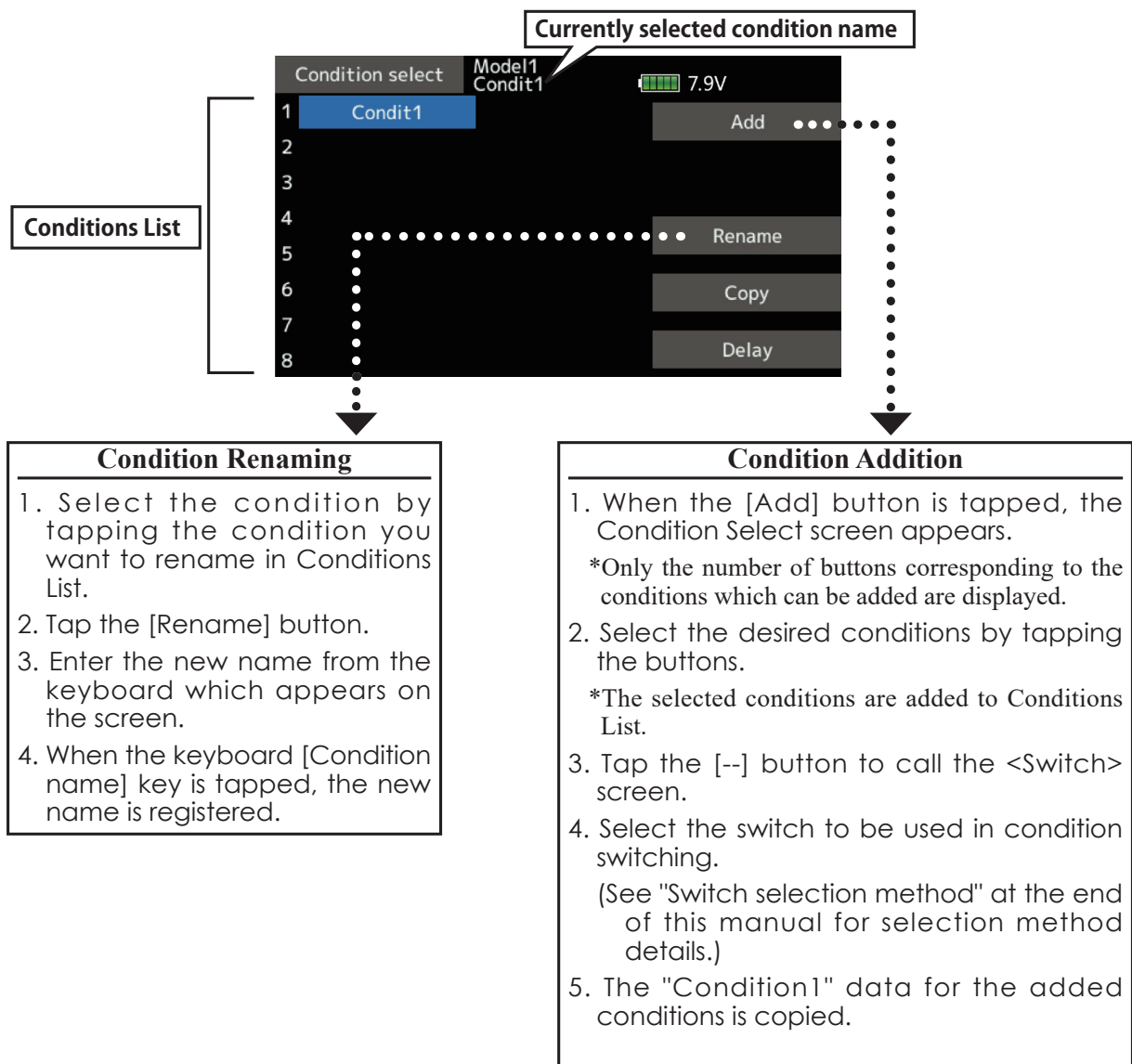

Condition Copy

1. Tap the [Copy] button. The Copy screen appears.
2. Select the condition by tapping the button of the copy source conditions.
3. Next, select the condition by tapping the copy destination condition.
4. Tap the [Copy] button.
5. When the [Yes] button is tapped, the data is copied. (To abort copying, tap the [No] button.)

Condition Remove

1. Select the condition by tapping the condition you want to reset in Conditions List.
2. Tap the [Remove] button.
3. When the [Yes] button is tapped, the condition is reset. (To abort resetting, tap the [No] button.)

Priority change

1. Tap the condition whose priority you want to change in Conditions List.
2. Change the priority with the priority [Δ] or [∇] button. (The last condition has the highest priority.)

*The initial setting condition cannot be moved. It has the lowest priority.

Condition delay setting

1. Switch to the condition you want to set.
2. Tap the Delay button of the channel you want to set.
3. Use the value input buttons to set the delay.
 - Initial value: 0
 - Adjustment range: 0~27 (maximum delay)

Ch	Function	Delay	Gr.
1	Aileron	0	Gr.
2	Elevator	0	Gr.
3	Throttle	0	Gr.
4	Rudder	0	Gr.
5	Gyro	0	Gr.
6	Gyro2	0	Gr.

AFR

The angle and curve of each operation function can be set. [All model types]

AFR function is used to adjust the throw and operation curve of the stick, lever, and switch functions for each flight condition.

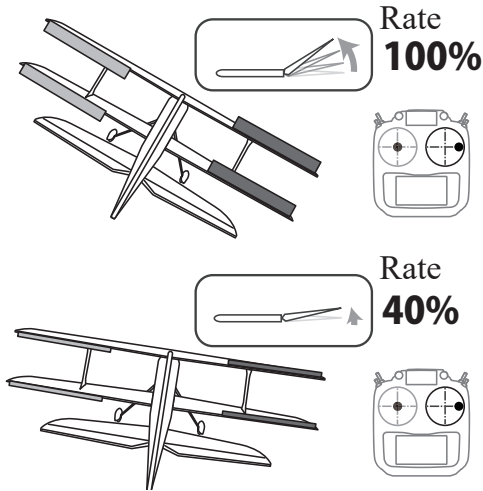

This is normally used after End Point has defined the maximum throw. When mixing is applied from one channel to another channel, both channels can be adjusted at the same time by adjusting the operation rate through the AFR function.

- Operation curve adjustment: Three types of curves (EXP1, EXP2, and Point) can be selected. A maximum 17 points curve can be used for the point curve type. (Initial setting: 9 points) The number of points can also be increased and decreased and curves from complex curves to simple curves can be used.
- Operation speed adjustment: The operation speed of each function when the function is operated (including at flight condition switching) can be adjusted. The function operates smoothly at a constant speed corresponding to the set speed.

When D/R is turned ON, the display will show "D/R----", and the rudder angle (rate) and EXP can be set when D/R is ON.

- Select [AFR] at the model menu and call the setup screen shown below.

•Return to Model menu

Curve select
EXP1, EXP2, Point curve

Curve select
Separately ⇔ Combination
(Left and right symmetrical curve.)

Left/right, Up/down, overall adjustment at Rate A and Rate B

● Operation curve setting
(For a description of the setting method, see the description at the back of this manual.)

Function selection

1. When the function select button is tapped, a selection screen appears.
2. Select the function you want to set at the selection screen.

● Group/single mode switch (Gr./Sngl)
(For more information, see the description at the back of this manual.)

● Servo speed setting
(For a description of the setting method, see the description at the back of this manual.)

Dual rate

D/R curves which can be switched by switch, etc. can be added. The curve can be adjusted by the AFR function.

- Up to 6 rates can be added for each condition.
- D/R is set for each condition and is not reflected at other conditions.
- D/R at the top of the D/R list has priority.

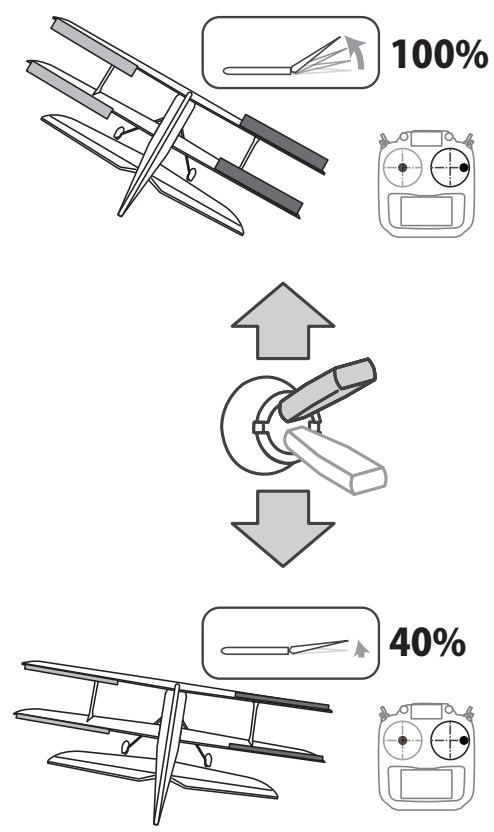

- Select [Dual rate] at the model menu and call the setup screen shown below.

•Return to Model menu

Dual rate		Model1	Condit1	7.9V
	Status	Function		Switch
1	D/R 1	INH	Aileron	SD
2	D/R 2	INH	Elevator	SA
3	D/R 3	INH	Rudder	SB
4	D/R 4	INH	Aileron	--
5	D/R 5	INH	Aileron	--
6	D/R 6	INH	Aileron	--

The ON/OFF switch of dual rate is chosen.

Activate the D/R function by tapping the [INH].

When the function select button is tapped, a selection screen appears. Select the function you want to set at the selection screen.

Rate, EXP settings are on AFR function

● **Setting rudder angle, EXP**
On this D/R screen you can set functions and switchover switches. Rudder angle (rate) and EXP settings are performed on the AFR screen when the D/R switch is ON.

Program. mixes

Program mixing which can be freely customized. Up to 10 mixings can be used for each condition. [All model types]

Programmable mixing may be used to correct undesired tendencies of the aircraft, and it may also be used for unusual control configurations. Mixing means that the motion of a command channel, called the "master," is added to the motion of the mixed channel, called "slave."

You may choose to have the Masters trim added to the Slave channel response, if you desire ("Trim" setting). The mixing curve can be changed so that the undesired tendencies can be corrected effectively by setting the EXP1/EXP2/Point modes.

Offset-type mixing applies a fixed offset or preset to the programmed channel servo operation and may control up to four circuits simultaneously.

The Programmable mixing includes a powerful link function, which allows Programmable mixing to be linked with the special mixing functions, or with other programmable mixing functions. The link function can be set up for Master and Slave channel individually.

- Tap the [Prog. mixes] button in the Model menu to call the setup screen shown below.

•Return to Model menu →

Channel	Mixing	Mode	Gr.
1	Inhibit	Offset	Gr.
2	Inhibit	Mixing	Gr.
3	Inhibit	Mixing	Gr.
4	Inhibit	Mixing	Gr.
5	Inhibit	Mixing	Gr.

● **Group/single mode switch (Gr./Sngl)**
(For more information, see the description at the back of this manual.)

After this function is activated, the master and slave function names (or offset mixing) are displayed.

Mixing/Offset mode switch

● **Operation curve setting**
(For a description of the setting method, see the description at the back of this manual.)

Activate the function by tapping the [INH].

The ON/OFF switch of prog. mixes is chosen.

Master function (or Stick, Switch, Dial) is chosen.

Slave function is chosen.

Servo speed setting

Trim mode setting ON/OFF.

Fine tuning trim setting

The on time (start/stop time) can be set up to 4 seconds. It is useful for landing gear control of the jet or scale plane, etc.

Setting methods

●Group/single mode selection

Activating functions for only the selected conditions:

1. Tap the [Gr] button and switch to the [Sngl] mode.

*Each time the button is tapped, it toggles between the Gr and Sngl modes.

●Mixing mode selection

Using the offset mode:

1. Tap the Mode button and switch to the Offset mode.

*Each time the button is tapped, it toggles between the Mixing and Offset modes.

●Mixing setup screen selection

1. Tap the button of the mixing you want to set. The mixing setup screen is displayed. Activate the function.

2. Activate the function by tapping the [INH] button.

*Each time this button is tapped, it toggles between [INH] and [ON/OFF].

●Mixing ON/OFF switch setting and ON/OFF direction switching

*An ON/OFF switch is not set even when the function is activated.

1. When you want to turn mixing ON/OFF by switch, tap the [--] button to call the <Switch> screen and then select the switch and its ON direction.

*For a description of the selection method, see [Switch setting method] at the back of this manual.

●Master channel setting (except offset type mixing)

1. Tap the Master button to call the Function menu and select the master channel.

2. To link this mixing with other mixing, tap the "Link" button.

*Each time the button is tapped, it toggles between mixing direction + and - and "OFF" (no link).

*Master channel control can be set to stick, VR, and other simple travels which do not include End point, AFR, D/R, mixing setting, etc. In this case, display the <Function,H/W> screen by tapping the [Stick, Switch, Dial] button and then select master channel side control.

●Slave channel setting

1. Tap the Slave button to call the Function menu and select the slave channel.

2. To link this mixing with other mixing, tap the "Link" button.

*Each time the button is pressed, it toggles between mixing direction + and - and "OFF" (no link).

●Trim mode ON/OFF setting

1. To turn the trim mode ON/OFF, tap the Trim button on the screen.

*When mixing includes master side trim, set the Trim button to [ON]. When mixing does not include master side trim, set the Trim button to [OFF].

*Each time this button is pressed, it toggles between [ON] and [OFF].

*This is effective when the master channel is set by Function.

●Mixing curve type selection

1. Tap the curve type selection button of the curve type you want to use to display the selection screen. Then, select the curve you want to use.

*For a description of the curve setting method, see the description at the back of this manual.

●Fine tuning trim setting

1. When using the curve fine tuning function, tap the [--] button of the Fine Tuning item to call the <Switch> screen and then select the lever, VR, etc. you want to use.

*For a description of the fine tuning trim setting method, see the description at the back of this manual.

●Servo speed setting

1. When setting the servo speed, tap the speed button. The Servo speed setup screen is displayed.

*For a description of the servo speed setting method, see the description at the back of this manual.

*Offset mixing changes the speed. Use the Speed In and Speed Out buttons to readjust the speed.

The mixing switch can set a delay with a different rate at starting and stopping.

*This function is inactive when a mixing switch is not set.

Aileron differential [Airplane/glider, 2 ailerons or more]

The left and right aileron differential can be adjusted independently. The differential rate can also be adjusted according to the flying state by setting a fine tuning VR.

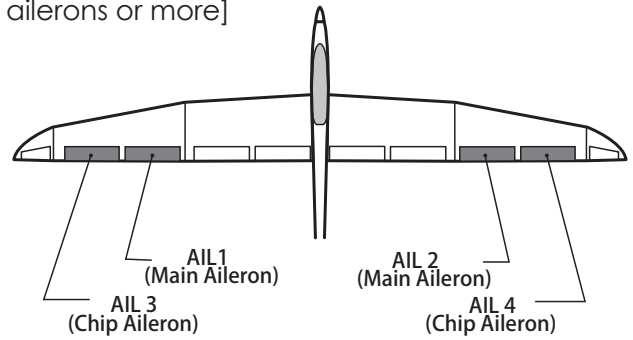

- Select [Aileron differential] at the model menu and call the setup screen shown below.
- Return to Model menu

Currently selected condition name

Aileron differential	Model1 Condit1	7.9V		
	Left	Right	Group	
Aileron	100	100	Gr.	<div style="border: 1px solid black; padding: 2px;"> Condition group/single mode selection (Gr. /Sngl) (For more information, see the description at the back of this manual.) </div>
Aileron2	100	100		
Aileron2	100	100		
Aileron4	100	100		

Aileron left/right adjustment

Fine tuning

--

Curve

*The display screen is an example. The actual screen depends on the Model Type.

Fine tuning VR setting
*The graph is operated by setting a VR, etc.

Aileron differential Model1 Condit1 7.9V

<p>Pos. +0 Rate +0</p>	<p>EXP 1 Separ.</p> <p>Offset 0.0</p> <p>Rate A Rate B</p> <p>+100.0 +100.0</p> <p>EXP A EXP B</p> <p>0.0 0.0</p>
------------------------	---

● **Fine tuning VR operation curve setting**
(For a description of the setting method, see the description at the back of this manual.)

Setting method

- Tap to the aileron (AIL) 1~4(2) left (or right) setting item.
Adjust the aileron angles.
- When setting the fine tuning VR, tap the "--" item and tap the screen to call the selection screen, and then select the fine tuning VR.
- The fine tuning rate can be set by curve.

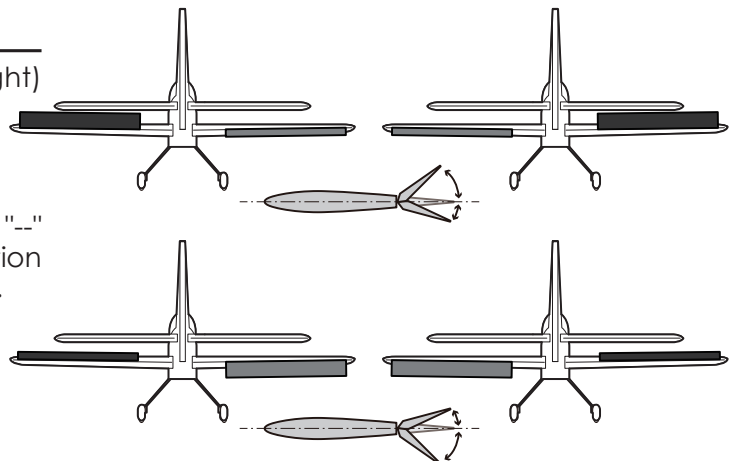

Flap setting

[Corresponding model type]: Airplane/
glider, 2 flaps or more

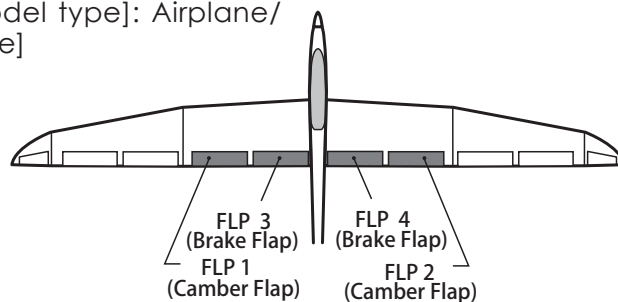

The up/down travel of each flap (camber flaps: FLP1/2, brake flaps: FLP3/4) can be adjusted independently at each servo according to the wing type.

- The operation reference point of each flap can be offset

The camber flaps of a 4-flap model can be mixed with the brake flaps. (Brake FLP to camber FLP)

- An ON/OFF switch can be set.
- Select [Flap setting] at the model menu and call the setup screen shown below.

•Return to Model menu

Flap setting Model1 Condit1 7.9V 1/2

Group	Camber flap		Brake flap	
	Flap	Flap2	Flap3	Flap4
Up	+100	+100	+100	+100
Down	+100	+100	+100	+100
Offset	+0	+0	+0	+0

Labels: Up side/Down side adjustment, Operation reference point offset, Camber flap setting, Brake flap setting, Currently selected condition name, Condition group/single mode selection (Gr./Sngl) (For more information, see the description at the back of this manual.)

Operation is performed via the volume switches, etc., set for each flap control of the function. Click The operational volume switch is set up by "Function"

Flap setting Model1 Condit1 7.9V 2/2

Group	Brake flap → Camber flap	
	Status	Mixing
Up	+100	INH
Down	+100	--
Offset	+0	

Labels: Up side/Down side adjustment, Operation reference point offset, Brake flap to Camber flap setting, Mixing INH ↔ ON, The ON/OFF switch of mixing is chosen.

*The display screen is an example. The actual screen depends on the Model Type.

Setting method

- Tap flap (FLP) 1~4 up or down according to the wing type.
Adjust the travel independently.
- To offset the operation reference point of each flap, tap the corresponding offset item. Use the "▼▼" "▼" "▲" "▲▲" button to offset the reference point.
- When using brake FLP to camber FLP mixing,

tap the [INH] item and tap the screen. (ON is displayed.)

When setting a switch, tap the [--] item of the switch and tap the screen to call the selection screen. Then, select the switch and set its ON direction. (Always ON at "--" setting) (For a description of the switch selection method, see the description at the back of this manual.)

AIL → Camber flap

[Corresponding model type]: Airplane/
glider, 2 ailerons + 2 flaps or more

This mix operates the camber flaps (FLP1/2) in the aileron mode. When the aileron stick is manipulated, the ailerons and camber flaps perform aileron operation simultaneously and the operation characteristic of the roll axis is improved.

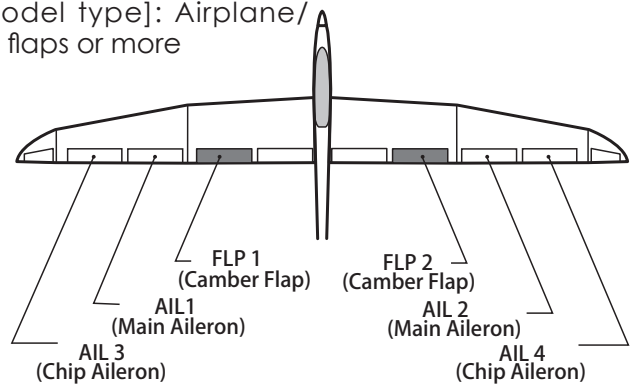

- The aileron left/right mixing rate of each flap servo can be fine-tuned.
- A mixing curve can be set.
- An ON/OFF switch can be set.
- Linking is possible: Link this mix to other mixes.
- Select [AIL→Camber flap] at the model menu and call the setup screen shown below.

- Return to Model menu

● **Mixing curve setting**
(For a description of the setting method, see the description at the back of this manual.)

Currently selected condition name

AIL → Camber flap Model1 Condit1 7.9V 1/2

Pos. +0 Rate +0

EXP 1 Separ. Offset 0.0 Rate A +100.0 Rate B +100.0 EXP A 0.0 EXP B 0.0

Left/right overall adjustment at Rate A and Rate B

Activate the function by tapping the [INH].

Condition group/single mode selection (Gr./Sngl)

The ON/OFF switch of mixing is chosen.

To set linking, tap to the [OFF] item

AIL → Camber flap Model1 Condit1 7.9V 2/2

Status INH

Group Gr.

Switch --

Link OFF

Travel

	Left	Right
Flap	+0	+0
Flap2	+0	+0

Adjustment of each flap servo

Setting method

- Tap [INH].
(ON is displayed.)
- When setting a switch, tap the [--] item of the switch and tap the screen to call the selection screen, and then select the switch and set its ON direction. (Always ON at "--" setting)
(For a description of the switch selection method, see the the back of this manual.)
- Tap the left or right item of each flap servo.
Adjust the mixing rate.

*When the mixing direction is reversed by the linkage, adjustments can be made by changing the mixing rate polarity (+ or -).

- A mixing curve can be set. (1/2 page)
(For a description of the mixing curve setting method, see the description at the back of this manual.)
- To set linking, tap the [Link] item.
Set it to ON and tap the screen.

AIL → Brake flap

[Corresponding model type]: Airplane/
glider, 4 flaps or more

This mix operates the brake flaps (FLP3/4) in the aileron mode. When the aileron stick is manipulated, the aileron and brake flaps perform the aileron operation simultaneously and the operation characteristic of the roll axis is improved.

- The aileron left and right mixing rates can be adjusted for each flap servo.
 - A mixing curve can be set.
 - Mixing during flight can be turned ON/OFF by setting a switch. (Always ON at [--] setting)
 - Linking can be set: Link this mix to other mixes.
- Select [AIL→ Brake flap] at the model menu and call the setup screen shown below.

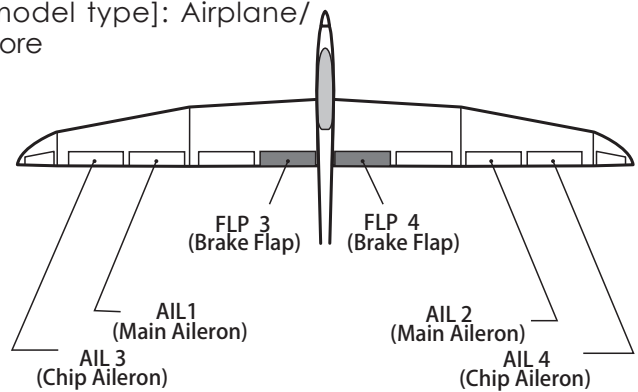

- Return to Model menu

● **Mixing curve setting**
(For a description of the setting method, see the description at the back of this manual.)

Currently selected condition name

AIL → Brake flap Model1 Condit1 7.9V 1/2

Pos. +0 Rate +0

EXP 1 Separ.

Offset 0.0

Rate A Rate B

+100.0 +100.0

EXP A EXP B

0.0 0.0

Left/right overall adjustment at Rate A and Rate B

Activate the function by tapping the [INH].

Condition group/single mode selection (Gr./Sngl)

The ON/OFF switch of mixing is chosen.

To set linking, tap to the [OFF] item

AIL → Brake flap Model1 Condit1 7.9V 2/2

Status INH

Group Gr.

Switch --

Link OFF

Travel

	Left	Right
Flap3	+0	+0
Flap4	+0	+0

Adjustment of each flap servo

● Setting method

- Tap the INH item.
(ON is displayed.)
- When setting a switch, tap to the [--] item of the switch and tap the screen to call the selection screen, and then select the switch and set its ON direction. (Always ON at "--" setting)
(For a description of the switch selection method, see the at the back of this manual.)
- Tap the left or right button of each flap servo. Adjust the mixing rate.

adjustments can be made by reversing the mixing rate polarity (+ or -).

- A mixing curve can be set.
(For a description of the curve setting method, see the description at the back of this manual.)
- To set linking, tap the Link item.
Set it to ON and tap the screen.

*When the mixing direction is reversed by the linkage,

Aileron → Rudder

[Corresponding model type]:
Airplane/glider, general

Use this mix when you want to mix the rudders with aileron operation.

- A mixing curve can be set.
- Mixing during flight can be turned ON/OFF by setting a switch. (Always ON at [-] setting)
- The mixing rate can be fine-tuned by setting a VR.

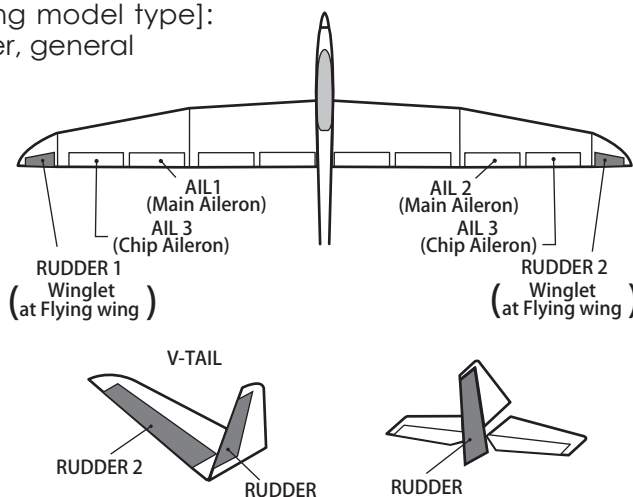
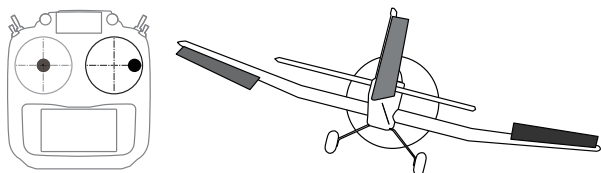

- Select [Aileron→ Rudder] at the model menu and call the setup screen shown below.

- Return to Model menu

● **Mixing curve setting**
(For a description of the setting method, see the description at the back of this manual.)

Currently selected condition name

Aileron → Rudder Model1 Condit1 7.9V 1/2

Pos. +0 Rate +0

EXP 1 Separ.

Offset 0.0

Rate A Rate B

+100.0 +100.0

EXP A EXP B

0.0 0.0

Left/right overall adjustment at Rate A and Rate B

Activate the function by tapping the [INH].

Condition group/single mode selection (Gr. /Sngl)

The ON/OFF switch of mixing is chosen.

Aileron → Rudder Model1 Condit1 7.9V 2/2

Status INH

Group Gr.

Switch --

Fine tuning

Control --

Mode

Rate +0 (+0)

Fine tuning VR setting

Operation mode

Adjustment rate

Setting method

- Tap [INH].
(ON is displayed.)
- When setting a switch, tap to the [--] item of the switch and tap the screen to call the selection screen, and then select the switch and set its ON direction. (Always ON at "--" setting)
(For a description of the switch selection method, see the back of this manual.)
- When setting a VR, tap to the Fine Tuning "--" item and tap the screen to call the selection screen, and then select the VR. The adjustment rate can be set. The VR operation mode can also be selected.
- A mixing curve can be set.
(For a description of the curve setting

method, see the description at the back of this manual.)

[Fine tuning VR operation mode]

[LIN.] Mixing rate 0% at center of VR. When the VR is turned clockwise and counterclockwise, the mixing rate increases and decreases, respectively.

[ATL+] Mixing rate 0% at left end of VR. When the VR is turned, the mixing rate increases.

[ATL-] Mixing rate 0% at right end of VR. When the VR is turned, the mixing rate increases.

[SYM.] When the VR is turned to the left or right of the neutral position, the mixing rate increases.

Elevator → Camber [Corresponding model type]: Airplane/glider, 2 ailerons or more

This function is used when you want to mix the camber flaps with elevator operation. When used, the flaps are lowered by up elevator, and lift can be increased.



Note: Tailless wing elevator can be operated when this mix is activated.

- A mixing curve can be set.
- Mixing during flight can be turned ON/OFF by setting a switch. (Always ON at [--] setting)
- The mixing rate can be fine-tuned by setting a VR.

- Select [Elevator→Camber] at the model menu and call the setup screen shown below.

- Return to Model menu

● **Mixing curve setting**
(For a description of the setting method, see the description at the back of this manual.)

Currently selected condition name

Elevator → Camber Model1 Condit1 7.9V 1/3

Pos. +0 Rate +0

EXP 1 Separ.

Offset 0.0

Rate A Rate B

+100.0 +100.0

EXP A EXP B

0.0 0.0

Overall adjustment by Rate A and Rate B.

Ailerons and flaps rate adjustment

	AIL3	AIL	AIL2	AIL4	RUD
Rate 1	+0	+0	+0	+0	+0
	(+0)	(+0)	(+0)	(+0)	(+0)
Rate 2	+0	+0	+0	+0	+0
	(+0)	(+0)	(+0)	(+0)	(+0)
	FLP3	FLAP	FLP2	FLP4	RUD2
Rate 1	+0	+0	+0	+0	+0
	(+0)	(+0)	(+0)	(+0)	(+0)
Rate 2	+0	+0	+0	+0	+0
	(+0)	(+0)	(+0)	(+0)	(+0)

The value inside the parentheses shows the current rudder position.

Activate the function by tapping the [INH].

Condition group/single mode selection (Gr./Snagl)

The ON/OFF switch of mixing is chosen.

Elevator → Camber Model1 Condit1 7.9V 3/3

Status INH

Group Gr.

Switch --

Fine tuning

Control --

Mode

Rate +0 (+0)

Fine tuning VR setting

Operation mode

Adjustment rate

Setting method

- Tap [INH].
(ON is displayed.)
- When setting a switch, tap the [--] item of the switch and tap the screen to call the selection screen, and then select the switch and set its ON direction. (Always ON at "--" setting)
(For a description of the switch selection method, see the description at the back of this manual.)

- When setting a VR, tap the Fine tuning "--" item and tap the screen to call the selection screen, and then select the VR. The adjustment rate can be set.
The VR operation mode can also be selected.
- A mixing curve can also be set.
(For a description of the curve setting method, see the description at the back of this manual.)

Camber mixing

[Corresponding model type]: Airplane/glider, 2 ailerons or more

This function adjusts the rate of camber operation which operates the wing camber (aileron, camber flaps, brake flaps) in the negative and positive directions. The aileron, flap, and elevator rates can also be adjusted independently by curve, and attitude changes caused by camber operation can be corrected.

*Initial setting assigns camber operation to side lever LS.

- The up/down side rates of the aileron, flap, and elevator servos can be adjusted by curve. When the mixing direction is reversed by the linkage, adjustments can be made by changing the mixing rate polarity (+ or -).
- Mixing during flight can be turned ON/OFF by setting a switch. (Always ON at [--] setting)
- A delay can be set for each condition. A cut switch which can turn OFF the delay function can be set.
- The speed of the aileron, flap, and elevator servos can be set. (In side/Out side)

- Select [Camber mixing] at the model menu and call the setup screen shown below.

Activate the function by tapping the [INH].

Condition group/single mode selection (Gr./Sngl)

The ON/OFF switch of mixing is chosen.

Condition delay cut switch

Condition delay setting

Currently selected condition name

Servo speed setting (For a description of the setting method, see the description at the back of this manual.)

• Return to Model menu

Ailerons, flaps and elevators rate adjustment

● **Mixing curve setting (For a description of the setting method, see the description at the back of this manual.)**

Overall adjustment by Rate A and Rate B.

Setting method

- Tap [INH].
(ON is displayed.)
- When setting a switch, tap to the [--] item of the switch and tap the screen to call the selection screen, and then select the switch and set its ON direction. (Always ON at "--" setting)
(For a description of the switch selection method, see the description at the back of this manual.)
- When setting a condition delay, tap to the [Condition delay] item.
Set the delay.

When setting a cut switch, tap [Cut-switch] and tap the screen to call the selection screen, and then select the switch and set its ON direction. (Always ON at [--] setting)
(For a description of the condition delay function, see the description at the back of this manual.)

(Curve/rate setup screen)

- The curve and rate are adjusted by calling the aileron, flap, and elevator curve/rate screens.
The rate and curve of each servo can be set by calling each screen. (For a description of the curve setting method, see the description at the back of this manual.)
The servo speed can also be adjusted.

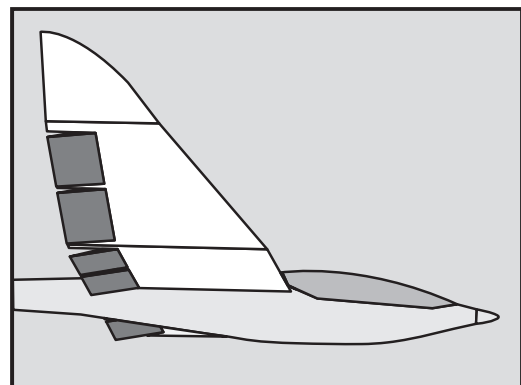
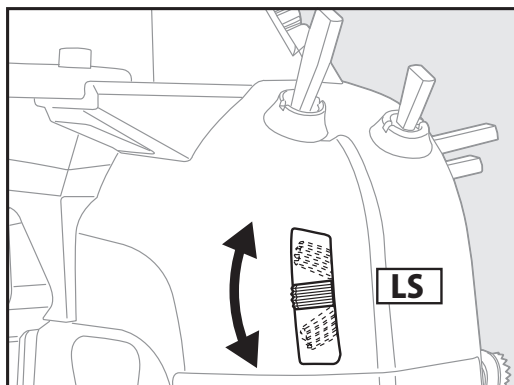
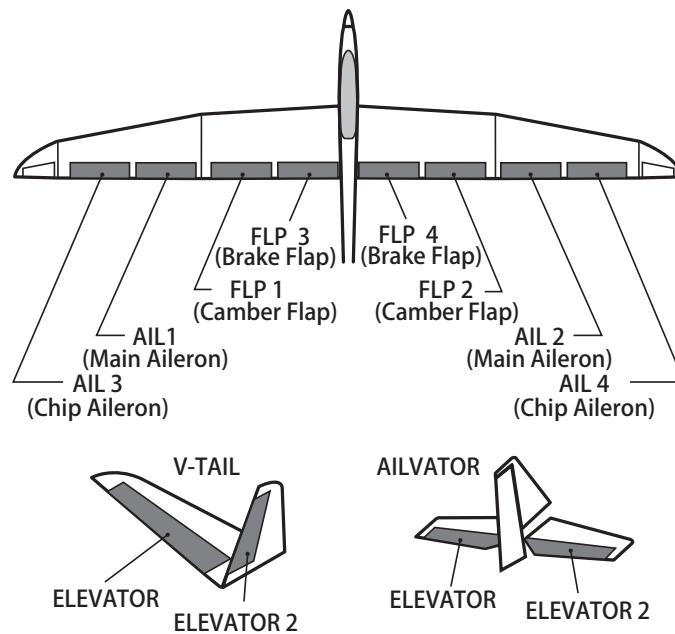

Airbrake → ELE

[Corresponding model type]:
Airplane/glider, general

This mix is used when you want to mix the elevators with airbrake (spoiler) operation. It raises the elevators to correct for dropping of the nose during airbrake operation.

*This function does not operate when airbrake is not assigned at the Function menu in the Linkage menu.

- The Rate 1 side/Rate 2 side mixing rate with the elevator servos can be adjusted.
- A mixing curve can be set.
- Mixing during flight can be turned ON/OFF by setting a switch. (Always ON at [--] setting)
- The mixing rate can be fine-tuned by setting a VR.

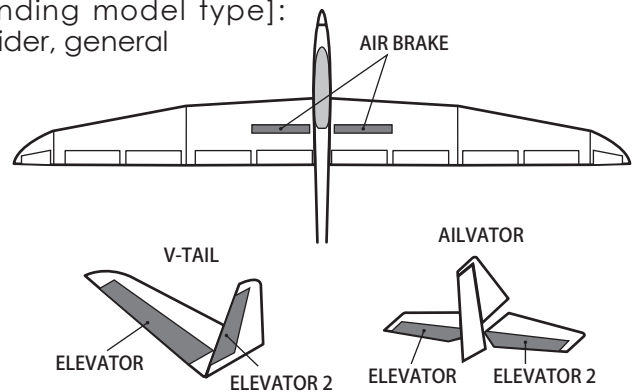

*The display screen is an example. The actual screen depends on the model type.

- Select [Airbrake→ ELE] at the model menu and call the setup screen shown below.

- Return to Model menu

● **Mixing curve setting**
(For a description of the setting method, see the description at the back of this manual.)

Currently selected condition name

Up/Down overall adjustment at Rate A and Rate B

Activate the function by tapping the [INH].

Condition group/single mode selection (Gr./Sngl)

The ON/OFF switch of mixing is chosen.

Adjustment of elevator servo

Fine tuning setting

Setting method

- Tap [INH].
(ON is displayed.)
- When setting a switch, tap the [--] item of the switch and tap the screen to call the selection screen, and then select the switch and set its ON direction. (Always ON at "--" setting)
(For a description of the switch selection method, see the description at the back of this manual.)
- When setting a VR, tap the Fine tuning

"--" item and tap the screen to call the selection screen, and then select the VR. The adjustment rate can be set. The VR operation mode can also be set.

(For a description of the fine tuning VR setting method, see the description at the back of this manual.)

- A mixing curve can be set.
(For a description of the curve setting method, see the description at the back of this manual.)

Camber flap → ELE

[Corresponding model type]: Airplane/
glider, 2 ailerons + 1 flap or more

This mixing is used to correct changes (elevator direction) generated when the camber flaps (speed flaps) are used.

- The elevator servos up side/down side rate can be adjusted. When the mixing direction is reversed by the linkage, adjustments can be made by changing the mixing rate polarity (+ or -).
- A mixing curve can be set.
- Mixing during flight can be turned ON/OFF by setting a switch. (Always ON at [--] setting)
- The mixing rate can be fine-tuned by setting a VR.

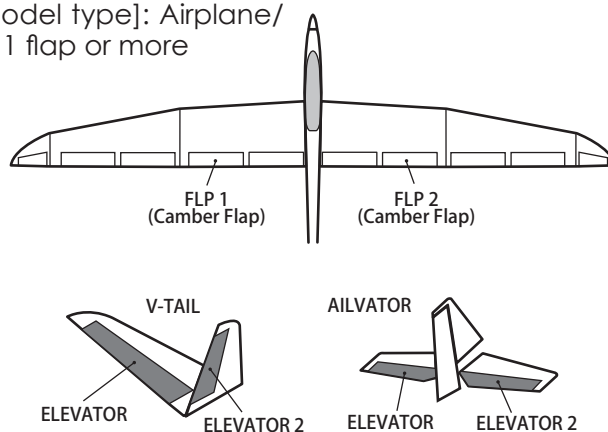

- Select [Camber flap→ELE] at the model menu and call the setup screen shown below.

- Return to Model menu

● **Mixing curve setting**
(For a description of the setting method, see the description at the back of this manual.)

Currently selected condition name

Camber flap → ELE Model1 Condit1 7.9V 1/2

Pos.	+0	Rate	+0
------	----	------	----

EXP 1	Separ.
Offset	0.0
Rate A	Rate B
+100.0	+100.0
EXP A	EXP B
0.0	0.0

Up/Down overall adjustment at Rate A and Rate B

- Activate the function by tapping the [INH].
- Condition group/single mode selection (Gr./Sngl)
- The ON/OFF switch of mixing is chosen.

Camber flap → ELE Model1 Condit1 7.9V 2/2

Status	INH
Group	Gr.
Switch	--

Travel	Rate 1	Rate 2
Elevator	+0	+0

Adjustment of elevator servo

Fine tuning Control	Rate	Mode
--	+0	(+0)

Fine tuning setting

Setting method

- Tap [INH].
(ON is displayed.)
- When setting a switch, tap to the [--] item of the switch and tap the screen to call the selection screen. Then, select the switch and set its ON direction. (Always ON at "--" setting)
(For a description of the switch selection method, see the description at the back of this manual.)
- Tap elevator servos. Adjust the mixing rate.

- *When the mixing direction is reversed by the linkage, adjustments can be made by changing the mixing rate polarity (+ or -).
- When setting a VR, tap the Fine tuning "--" item and tap the screen to call the selection screen, and then select the VR. The VR operation mode can be selected.
- A mixing curve can be set.
(For a description of the curve setting method, see the description at the back of this manual.)

Rudder → Aileron

[Corresponding model type]:
Airplane/glider, general

This function is used when you want to mix the ailerons with rudder operation. It is used when rudder is applied during roll maneuvers, knife edge, etc. of acrobatic planes. It can be used to bank scale models, large models, etc. like a full size plane.

- A mixing curve can be set.
- Mixing during flight can be turned ON/OFF by setting a switch. (Always ON at [-] setting)
- Linking can be set: Link this mix to other mixes.
- The mixing rate can be fine-tuned by setting a VR.

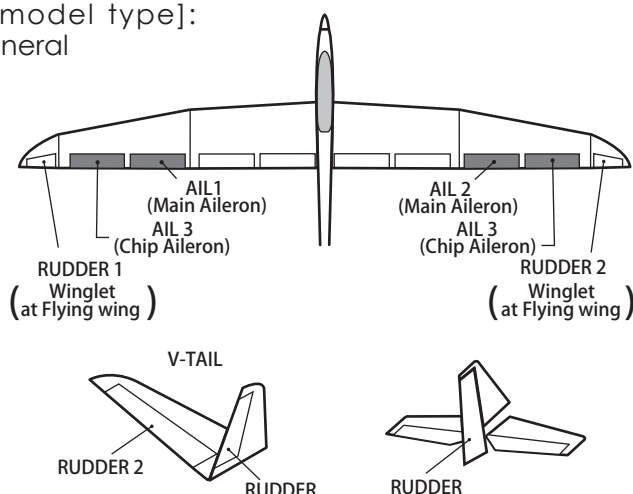

- Select [Rudder→Aileron] at the model menu and call the setup screen shown below.

- Return to Model menu

● **Mixing curve setting**
(For a description of the setting method, see the description at the back of this manual.)

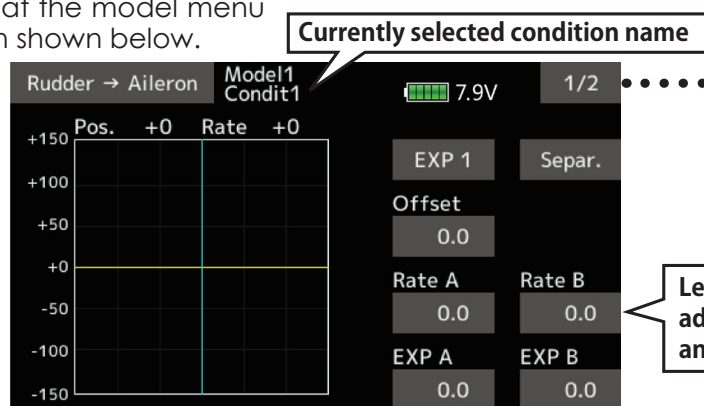

Activate the function by tapping the [INH].

Condition group/single mode selection (Gr./Sngl)

The ON/OFF switch of mixing is chosen.

To set linking, tap to the [OFF] item

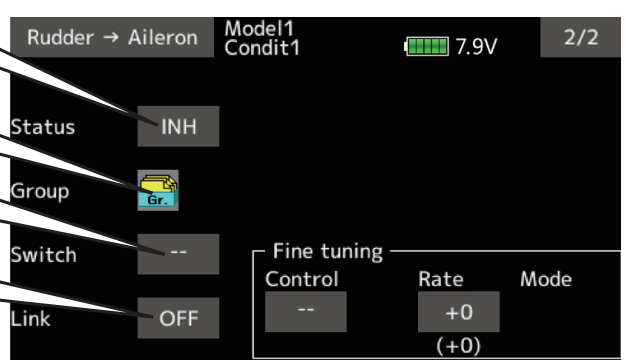

Left/right overall adjustment at Rate A and Rate B

Fine tuning setting

Setting method

- Tap [INH].
(ON is displayed.)
- When setting a switch, tap to the [--] item of the switch and tap the screen to call the selection screen. Then, select the switch and set its ON direction. (Always ON at "--" setting)
(For a description of the switch selection method, see back of this manual.)
- When setting a VR, tap to the Fine tuning "--" item and tap the screen to call the selection screen and then select the VR. The adjustment rate can be set.

The VR operation mode can also be set.
(For a description of the fine tuning VR setting method, see the description at the back of this manual.)

- A mixing curve can be set.
(For a description of the curve setting method, see the back of this manual.)
- When linking: tap the [Link] item. (ON is displayed.)

Rudder → Elevator

[Corresponding model type]: Airplane, general

This function is used when you want to mix elevator operation with rudder operation. It is used to correct undesirable tendencies when rudder is applied in roll maneuvers, knife edge, etc. of acrobatic planes.

- Link can be set: Links this mixing to other mixings.
- The mixing rate can be fine-tuned by setting a VR. (Fine tuning)

- A mixing curve can be set.
- Mixing during flight can be turned ON/OFF by setting a switch. (Always ON at [--] setting)

- Select [Rudder→Elevator] at the model menu and call the setup screen shown below.

- Return to Model menu

● **Mixing curve setting**
(For a description of the setting method, see the description at the back of this manual.)

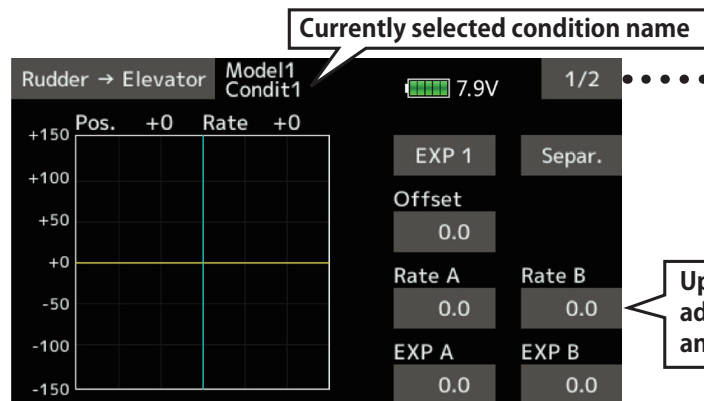

Activate the function by tapping the [INH].

Condition group/single mode selection (Gr./Sngl)

The ON/OFF switch of mixing is chosen.

To set linking, tap to the [OFF] item

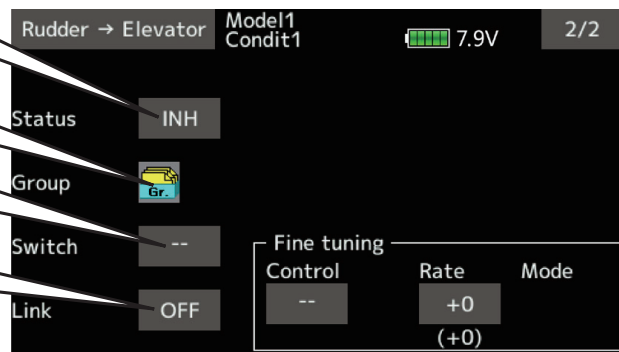

Fine tuning setting

Setting method

- Tap [INH].
(ON is displayed.)
- When setting a switch, tap to the [--] item of the switch and tap the screen to call the selection screen. Then, select the switch and set its ON direction. (Always ON at "--" setting)
(For a description of the switch selection method, see the description at the back of this manual.)
- When setting a VR, tap the Fine tuning "--" item and tap the screen to call the selection screen and then select the VR. The

adjustment rate can be set.

The VR operation mode can also be set.

(For a description of the fine tuning VR setting method, see the description at the back of this manual.)

- A mixing curve can be set.
(For a description of the curve setting method, see the description at the back of this manual.)
- When linking: tap the [Link] item. (ON is displayed.)

Butterfly

[Corresponding model type]: Glider, 2 ailerons or more

This function allows powerful brake operation by simultaneously raising the left and right ailerons and lowering the flaps (camber flap, brake flap).

This setting will allow the ailerons to be raised while the flaps are simultaneously lowered. Butterfly (crow) produces an extremely efficient landing configuration by accomplishing the following:

1. Slow the aircraft's velocity.
2. Provide washout at the wing tips to reduce the tendency to tip stall.
3. Create more lift toward the center of the wing allowing it to fly at a slower speed.

- Mixing during flight can be turned ON/OFF by setting a switch. (Always ON at [--] setting)
 - The butterfly operation reference point can be offset. When the screen is tapped with the offset item selected when operated to the position to be changed, the reference point is offset. If the reference point is offset too much, unexpected operation may be performed.
 - The ailerons and flaps operation speed can be adjusted. (In side/Out side)
 - A delay can be set for each condition. A cut switch which can turn OFF the delay function can also be set.
 - The differential rate can be adjusted.
- *When servo binding occurs when setting the ailerons and flaps in butterfly mixing, use the AFR function to adjust the rate.
- *The display screen is an example. The actual screen depends on the model type.

When using this function, Tap [INH]. (ON is displayed.)

Condition group/single mode selection (Gr. / Sngl)

The ON/OFF switch of mixing is chosen.

Condition delay setting

- Select [Butterfly] at the model menu and call the setup screen shown below.

To next page

Condition delay cut switch

The differential rate can be adjusted.

*When differential rate is "+", Up rate is decrease and DOWN rate is increase.

*When differential rate is "-", the calculation method of UP/DOWN and a direction become reverse.

When offsetting the butterfly operation reference point, operate to the throttle stick point you want to change and then touch the Offset button. The reference point displays 0%. When [Yes] is touched, the reference point is changed. Then, "Initialize elevator curve?" appears, allowing you to confirm your setting.

*The display screen is an example. The actual screen depends on the Model Type.

•Return to Model menu →

Butterfly NEW Condit.1 7.9V 2/2

Mixing rate

AIL3	AIL	AIL2	AIL4		
+0	+0	+0	+0		
FLP3	FLAP	FLP2	FLP4	ABK	Mode
+0	+0	+0	+0	+0	A

Elevator setting

Curve	Rate 1	ELE	ELE2	Fine tuning	Control
		+0	+0		RD
	Rate 2	+0	+0	Rate (+0)	Mode
				+20	LIN.

Select the Mixing Rate AIL and FLP box. Adjust the mixing rates.

Elevator rate adjustment

Fine tuning setting

*In case of tailless wing not display.

(To elevator curve setup screen)

(Elevator correction rate setup screen)

Butterfly Model1 Condit.1 7.9V

Pos. -84 Rate +0

Point Separ.

Offset 0.0 Add

Position 0.0 Rate +34.5

← →

The offset position is indicated by a red dotted line by an elevator curve.

Overall adjustment by Rate A and Rate B

Mixing curve setting
*For a description of the curve setting method, see the description at the back of this manual.

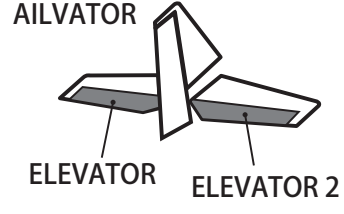
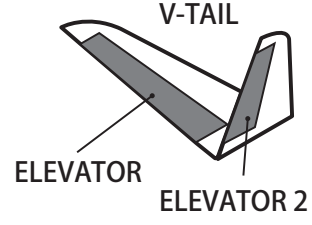
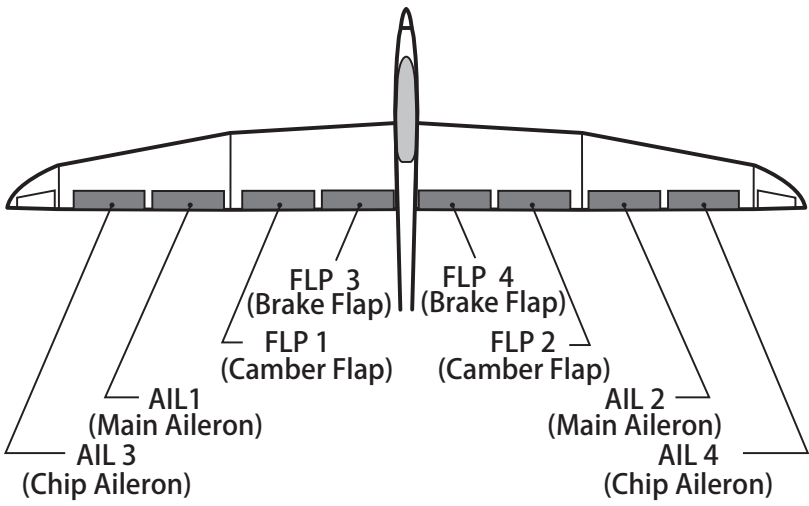
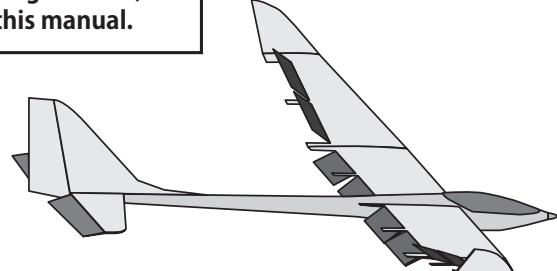

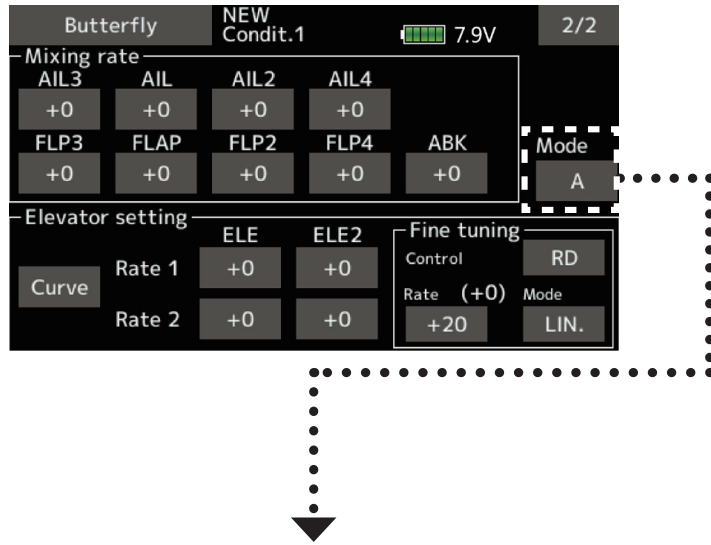

Throttle stick full stroke MODE

- Mode A
(Normal)
- The butterfly operation direction is reversed at the neutral position (50) of the throttle stick.
- Mode B
(Throttle stick full stroke MODE)
- It does not reverse at the neutral position, so you can set the butterfly operation start point with the full stroke of the throttle stick.

At offset 20



At offset 20

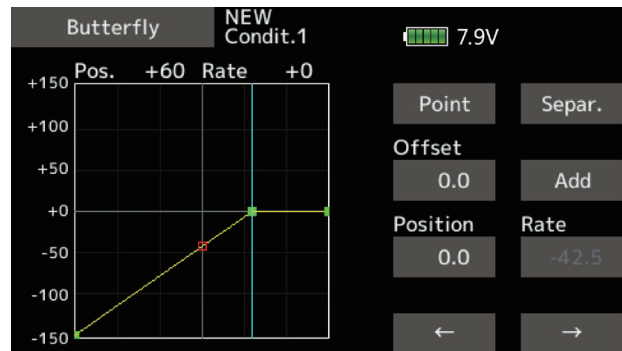

At offset 70



The direction of butterfly motion is reversed.

At offset 70



The direction of butterfly motion is not reversed.

Trim mix 1/2

[Corresponding model type]: Glider, general

These functions call the ailerons, elevators, and flaps (camber flaps, brake flaps) trim offset rates preset according to the flight state.

The amount of ailerons, elevator, and flaps (camber flap, brake flap) trim offset can be set to a switch.

As an example **Trim mix 1** can be set up for launching, with speed flaps and ailerons dropped, and a slight amount of up elevator. **Trim mix 2** can be used for high speed flying, with both ailerons and speed flaps reflexed slightly, and a bit of down elevator.

The trim functions can be activated during flight by setting a switch. To prevent sudden trim changes when switching flight conditions, a delay can be set to provide a smooth transition between the two. Trim mix 2 will have priority over Trim mix 1.

Example

1. Move to the [INH] item. Set the trim mix function to [ON].
*When separating the settings for each condition, move to the [Group] item and set it to [Single].
2. Select the ON/OFF switch.
3. Select the [Manual] or [Auto] mode.
In the [Auto] mode, also select an auto SW. This switch can be linked to a stick, etc.

<Speed>
In: The operation speed at switch ON can be set.
Out: The return speed at switch OFF can be set.

<Fine Tuning>
The offset rate can be varied in the Fine Tuning numeric range set at screen by VR, etc. selection.

<Condition Delay>
When flight conditions are set, the operation speed can be set for each condition. Condition delay operation can be interrupted and each rudder quickly returned to its original position by selecting a cut switch.

*The display screen is an example. The actual screen depends on the Model Type.

When using this function, Tap [INH]. (ON is displayed.)

The ON/OFF switch of mixing is chosen.

Manual/Auto mode selection
Manual: Switches the function ON/OFF by switch
Auto: Trim mix function call can be linked to a stick, etc. A stick switch, etc. separate from the function ON/OFF switch is set.

Condition delay setting

- Select [Trim mix1 or 2] at the model menu and call the setup screen shown below.

To next page

Trim mix 1	Model1 Condit1	Speed	In	Out
Status	INH	Aileron	0	0
Switch	--	Flap	0	0
Mode	Manual	Elevator	0	0
Auto switch	--	Air brake	0	0
Delay	0	Fine tuning Control		
Cut switch	--	--		

Condition delay cut switch

When a fine tuning VR is set, the trim rates of ailerons, flaps and elevators can be adjusted.

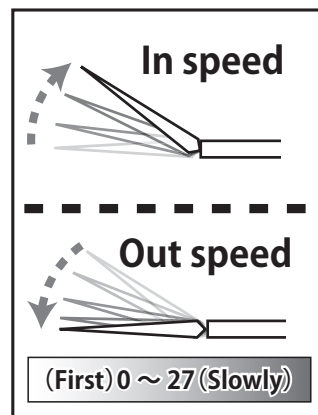

- Return to Model menu

Trim mix 1	Model1 Condit1	AIL3	AIL	AIL2	AIL4	ABK
Offset		+0	+0	+0	+0	+0
Fine tuning		+0	+0	+0	+0	+0
		(+0)	(+0)	(+0)	(+0)	(+0)
FLP3	FLAP	FLP2	FLP4	ELE	ELE2	
+0	+0	+0	+0	+0	+0	+0
+0	+0	+0	+0	+0	+0	+0
(+0)	(+0)	(+0)	(+0)	(+0)	(+0)	(+0)

The value inside the parentheses shows the current rudder position.

The offset rate of ailerons, flaps and elevators can be adjusted. Tap to the corresponding setting item. Adjust the rate.

Snap roll

[Corresponding model type]: Airplane, general

This function selects the switch and rate adjustment of each rudder, (ailerons, elevators, or flaps) when a snap roll is performed.

- Four snap roll directions can be set. (Right/up, right/down, left/up, left/down)
- Operation mode: When [Master] mode is selected, the Snap Roll function is turned ON/OFF by master switch in the state in which the direction switch was switched to the direction in which you want to snap roll. When [Single] mode is selected, snap roll in each direction can be executed by means of independent switches.
- A safety switch can be set. As a safety measure, the switch can be set so that snap roll is not executed when, for instance, the landing gear is lowered, even if the switch is turned on accidentally. The snap roll switch is activated only when the safety switch is ON.
- The operation speed of the aileron, elevator, and flap servos can be adjusted for each snap roll direction. (In side/out side)

(Example) Setting example for F3A

- Mode: [Master]
- Safety SW: [SW-G] (Safety measure)
- Master SW: [SW-H] (Main switch for executing snap roll)
- Direction switches:
*The snap roll up side left and right and down side left and right direction switches are selected here.

Right/Up: [SW-D] OFF-OFF-ON
 Right/Down: [SW-D] ON-OFF-OFF
 Left/Up: [SW-A] OFF-OFF-ON
 Left/Down: [SW-A] ON-OFF-OFF

- Speed adjustment
The operation speed of each control surface when the snap switch is ON can be changed and snap roll executed by stick while there is switch operation can be performed

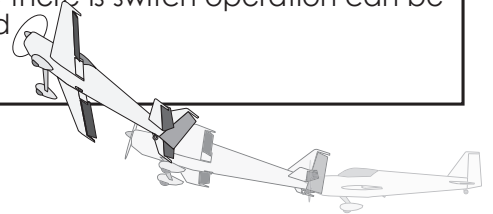

- Select [Snap roll] at the model menu and call the setup screen shown below.

•Return to Model menu

Master or Single is chosen

Snap roll directions

Snap roll		Model1 Condit1	7.9V 1/2		
Mode	Master-SW	Safety-SW			
	ACT/INH	Switch	Aileron	Elevator	Rudder
Right/Up	OFF	--	+100	+100	+100
Right/Down	OFF	--	+100	-100	-100
Left/Up	OFF	--	-100	+100	-100
Left/Down	OFF	--	-100	-100	+100

Master mode : Direction switches
Single mode : Snap roll switches

The ON/OFF switch of snap roll is chosen.

The safety switch is chosen.

To next page

Condition group/ single mode selection (Gr./Sngl)

Snap roll		Model1 Condit1	7.9V 2/2					
Speed		Aileron		Elevator		Rudder		
		In	Out	In	Out	In	Out	
Right/Up		0	0	0	0	0	0	
Right/Down		0	0	0	0	0	0	
Left/Up		0	0	0	0	0	0	
Left/Down		0	0	0	0	0	0	

In speed

Out speed

(First) 0 ~ 27 (Slowly)

Air brake

[Corresponding model type]: Airplane, general

This function is used when an air brake is necessary when landing or diving, etc.

The preset elevators and flaps (camber flap, brake flap) offset amount can be activated by a switch.

The offset amount of the aileron, elevator, and flap servos can be adjusted as needed. Also the speed of the aileron, elevator, and flap servos can be adjusted. (In side/Out side) A delay can be set for each condition, and a Cut switch which will turn OFF the delay can be chosen. Trim amounts can be fine-tuned by setting a VR. You can also set the Auto Mode, which will link Airbrake to a stick, switch, or dial. A separate stick switch or dial can also be set as the ON/OFF switch.

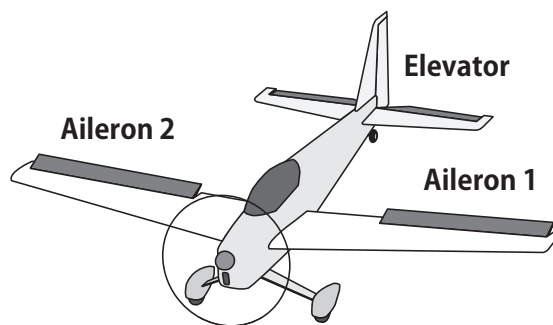

- Select [Air brake] at the model menu and call the setup screen shown below.

*The display screen is an example. The actual screen depends on the Model Type.

When using this function, Tap [INH]. (ON is displayed.)

The ON/OFF switch of air brake is chosen.

Manual/Auto mode selection
Manual: Switches the function ON/OFF by switch
Auto: Air brake function call can be linked to a stick, etc. A stick switch, etc. separate from the function ON/OFF switch is set.

Air brake		Model1 Condit1	7.9V	1/2
Status	INH			
Switch	--	Speed	In	Out
Mode	Manual	Aileron	0	0
Auto switch	--	Flap	0	0
Delay	0	Elevator	0	0
Cut switch	--	Air brake	0	0
		Fine tuning		
		Control	--	

Condition delay setting and cut switch setting.

Fine tuning setting

In speed

Out speed

(First) 0 ~ 27 (Slowly)

• Return to Model menu

Air brake		Model1 Condit1	7.9V	2/2	
Offset	AIL3 +0	AIL +0	AIL2 +0	AIL4 +0	ABK +0
Fine tuning	+0 (+0)	+0 (+0)	+0 (+0)	+0 (+0)	+0 (+0)
	FLP3 +0	FLAP +0	FLP2 +0	FLP4 +0	ELE +0
	+0 (+0)	+0 (+0)	+0 (+0)	+0 (+0)	+0 (+0)

The value inside the parentheses shows the current rudder position.

Offset : The offset rate of ailerons, flaps, and elevators can be adjusted. Tap to the corresponding setting item. Adjust the rate.

Fine tuning : When a fine tuning VR is set on the next page, the ailerons', flaps', and elevators' trim rates can be adjusted. Tap to the corresponding setting item. Adjust the rate.

Gyro

[Corresponding model type]: Airplane/glider/multicopter, general

This function is used when a GYA Series gyro is used to stabilize the aircraft's attitude. The sensitivity and operation mode (Normal mode/GY mode) can be switched with a switch.

- Three rates (Rate 1/Rate 2/Rate 3) can be switched.
- Up to 3 axes (Gyro/Gyro 2/Gyro 3) can be simultaneously controlled.

*Initial setting does not assign a sensitivity channel. Use the Function menu of the Linkage menu to assign the sensitivity channel (Gyro/Gyro2/Gyro3) used to a vacant channel beforehand.

Set [Control] and [Trim] other than Function to [--].

- Select [Gyro] at the model menu and call the setup screen shown below.

•Return to Model menu

Tapping this will change INH to either ON or OFF and enable operation. Adjustment of the three rates (sensitivity) and switching between Normal and AVCS is possible.

Gyro		Rate 1		Rate 2		Rate 3	
	INH	Gr.		INH	Gr.	INH	Gr.
Type	Switch	Type	Switch	Type	Switch	Type	Switch
	GY	--		GY	--	GY	--
Mode	Rate	Mode	Rate	Mode	Rate	Mode	Rate
GYRO	Normal 0	Normal 0	Normal 0	Normal 0	Normal 0	Normal 0	Normal 0
GYR2	Normal 0	Normal 0	Normal 0	Normal 0	Normal 0	Normal 0	Normal 0
GYR3	Normal 0	Normal 0	Normal 0	Normal 0	Normal 0	Normal 0	Normal 0

The operation mode (AVCS/NOR) and sensitivity of the 3 axes Gyro/Gyro2/Gyro3 can be set.

Condition group/ single mode selection (Gr. /Sngl)

The ON/OFF switch of gyro is chosen.

3 rate (gyro gain) adjustment

- Three rates (Rate 1/Rate 2/Rate 3) can be used.
Tap to the [Rate] item. Adjust the rate.
- When using this function, Tap [INH].
- When a Futaba GYA gyro is used, when [GY] type is selected, the sensitivity set value is directly read in both the AVCS and Normal modes.
- When setting a switch, tap the Switch item and tap the "--" button to call the selection screen, and then select the switch and set its ON direction.
(For a description of the switch selection method, see the description at the end of this manual.)

(Example) Setting three axis using a GYA450 and GYA451 (2)

- Wing type: Aileron 2 servos mounted fuselage selected
- Set **5CH → Gyro** (GYA451AIL), **7CH → Gyro2** (GYA451ELE), **8CH → Gyro3** (GYA450RUD), **Control and Trim → "--"** : at the Function menu of the Linkage menu.
- Gyro setting of the Model menu.

Rate	ACT	Type	Switch	Gyro	Gyro 2	Gyro 3
1	OFF/ON	GY	SE	AVCS : 60%	AVCS : 60%	AVCS : 60%
2	INH					
3	ON/OFF	GY	SE	Normal : 60%	Normal : 60%	Normal : 60%

*Set so that Rate 1 is turned on at the back position of switch E and Rate 3 is turned ON at the front position. Since switch E is turned OFF at the center, Rate 2 remains [INH].

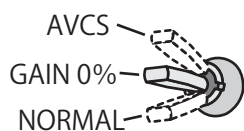

When AVCS is used we recommend that the sensitivity CH be set to the 3-position.

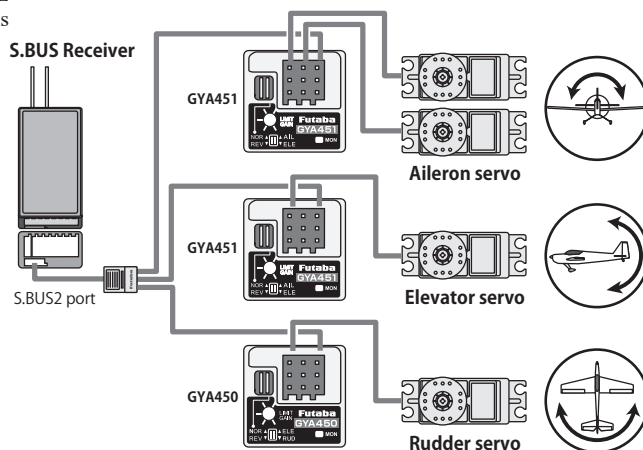

Ailevator

[Corresponding model type]: Airplane/glider, Tail type Ailevator (Effective only when 2 servos used at the elevators)

This function improves the operating performance of the roll axis by operating the elevators as ailerons.

Ailevator is where each elevator in a standard (conventional) or v-tail moves independently, like ailerons on a wing. In addition to each elevator side moving up and down together, each side moves in opposite directions when moving as an ailevator. On a V-tail, this is also known as a ruddervator, as they can serve the same purpose. Typically, both ailevator and ailerons are coupled together to maximize roll performance, especially on larger wingspan planes.

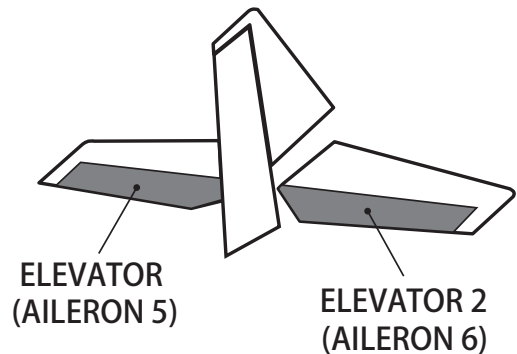

Note: Select ailevator as the Model type at the Model type screen. This changes the output channel. Check the Function menu.

- Select [Ailevator] at the model menu and call the setup screen shown below.

• Return to Model menu →

**Condition group/
single mode
selection (Gr. /Sngl)**

Ailevator		Model1 Condit1		7.9V	
Group					
		Elevator		Aileron	
		Down	Up	Left	Right
Elevator (Aileron 5)	Gr.	+100	+100	+0	+0
Elevator2 (Aileron 6)	Gr.	+100	+100	+0	+0

(Elevator function)
The up and down rates of the left and right elevators when the elevator stick is manipulated can be individually adjusted.

(Aileron function)
When the elevators are used as ailerons, aileron travel of the left and right elevators can be adjusted.

- Travel adjustment

Tap to the item you want to adjust.

Adjust the rate using the "▼▼" "▼" "▲" "▲▲" buttons.

*If the mixing direction is reversed by the linkage, adjustments can be made by changing the mixing rate polarity (+ or -).

*If a large value of travel is specified, when the sticks are moved at the same time, the controls may bind or run out of travel. Decrease the travel until no binding occurs.

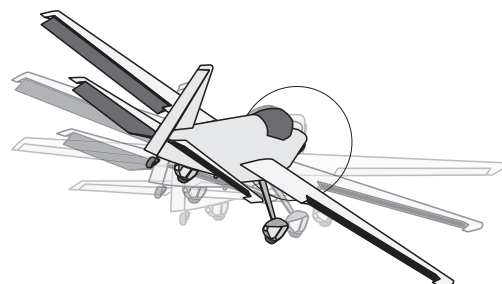

Acceleration

[Corresponding model type]: Airplane/glider general

Acceleration setting can be performed at Elevator, Elevator → Camber and Aileron → Rudder. (Glider only)

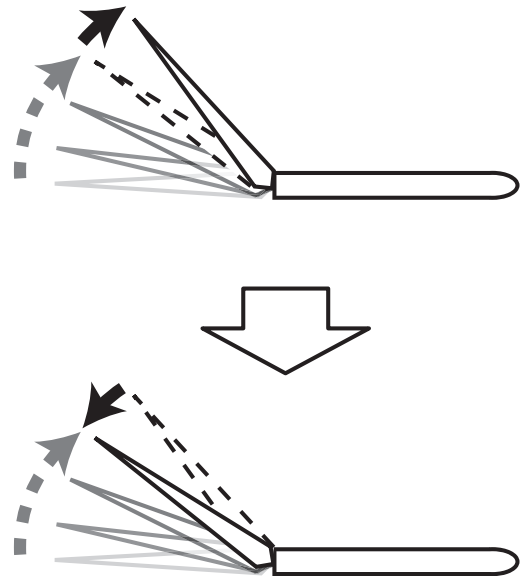

- This setting is divided into elevator setting and camber setting. The setting method is the same.
- Camber setting sets the acceleration function for Ele to camber mixing. Setting is not performed when Ele to camber mixing is INH.
- The acceleration function can be set for both the up side and down side.
- Function ON/OFF switch setting is performed for Aileron → Rudder setting only.
- Aileron → Rudder setting is acceleration function setting for Aileron → Rudder mixing. It is not performed when Aileron → Rudder mixing is INH.

- Select [Acceleration] at the model menu and call the setup screen shown below.

When using this function, Tap [INH]. (ON is displayed.)

Condition group/ single mode selection (Gr. /Sngl)

**To next page
2/3 : Elevator → Camber
3/3 : Aileron → Rudder**

• Return to Model menu

The rate the angle increases.

Operation up to this range will initiate acceleration.

Act position

Current position

**The return time after operation (Damping) can be set.
(First return) 1 ~ 100 (Slow return)
(Acceleration doesn't function as 0.)**

Setting method

- Acceleration rate setting (Rate)
- The return time after operation (Damping) can be set.
- The operation point at acceleration and deceleration can be set. When an operation point is exceeded, acceleration is performed.

Note: When using the acceleration function, since the servo stroke is large, make your settings so there is no binding of your linkage.

Motor

[Corresponding model type]: Airplane/glider, general

This function lets you set the operation speed when the motor of an F5B or other EP glider is started by switch. The operation speed can be set in 2 ranges of slow speed flight and high speed flight (Speed 1/ Speed 2). This function can also be operated as a safety function by setting 2 switches.

- The in side and out side operating speeds can be adjusted independently in 2 ranges (Speed 1/ Speed 2).
- The boundary between the 2 ranges can be set. (From speed 1 to speed 2)

- Select [Motor] at the model menu and call the setup screen shown below.

- The set operation speed operation can be activated at initial operation only. (1 time operation) However, operation can be repeated by setting the switch to OFF before operation is finished. When you want to reset 1 time operation, set the ACT/INH item to [INH] and then reset it to [ON].
- The motor (CH3) is controlled by SW-G. (Initial setting) When changing the switch or stick which controls the motor, first change Function of the Linkage menu.

Note: When using this function, always check initial operation with the propeller removed.

- Return to Model menu

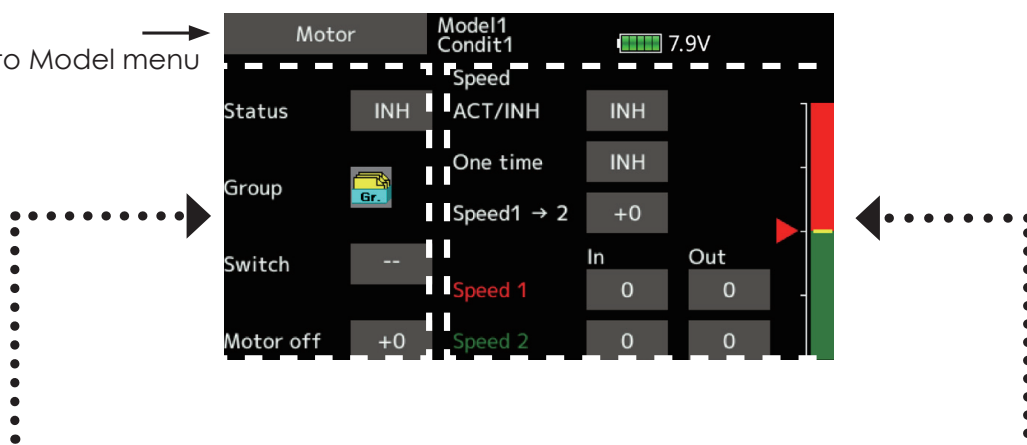

- When using this function, Tap [INH].
- Group/single mode switching (For more information, see the description at the back of this manual.)
- Switch
A switch that turns the function itself ON/OFF can be selected.
- Motor off position
Tap the motor off button when [SW-G] is in the motor OFF position you want to set. The direction of the motor switch is memorized. The screen graph display OFF direction also changes.

- When using this function, Tap [INH].
- When you want to set the "One time mode", tap to the [One time] item and tap the screen.
- Speed 1 to 2
The speed 1 and speed 2 region boundary can be changed,
- Operation speed adjustment
The speed when speed 1 and speed 2 are ON (In) and OFF (Out) can be adjusted.

Notes

- First decide the motor OFF direction, and then set the speed. When you want to reset the motor OFF direction, also reset the speed.
- We recommend that motor OFF be set in combination with F/S.
- Set the basic operation direction with the reverse function to match the ESC used.
- Always set the motor OFF position.

V-Tail

[Corresponding model type]: Airplane/glider, Tail type V-tail

This function lets you adjust for left and right rudder angle changes at elevator and rudder operation of a V-tail airplane.

V-tail is when 2 servos are used together to control rudder movement as elevators. In addition to each rudder side moving up and down together, each side moves in opposite directions when moving as elevators. On a V-tail, this is also known as a ruddervator, as they can serve the same purpose.

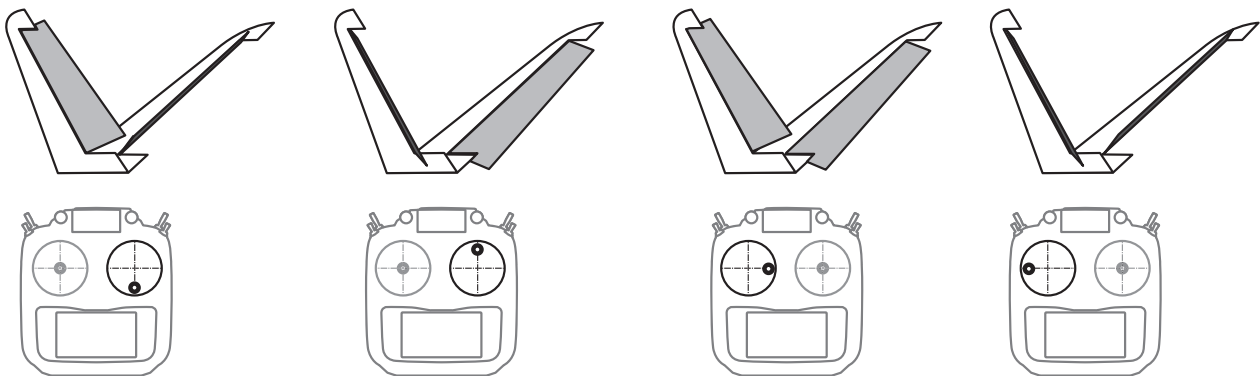
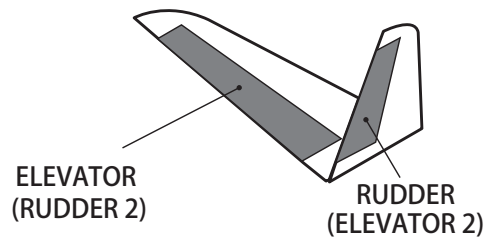

- Select [V-Tail] at the model menu and call the setup screen shown below.

- Return to Model menu

- Travel adjustment
 - Tap to the item you want to adjust.
 - Adjust the rate using the "▼▼" "▼" "▲" "▲▲" buttons.
 - *If the mixing direction is reversed by the linkage, adjustments can be made by changing the mixing rate polarity (+ or -).
 - *If a large value of travel is specified, when the sticks are moved at the same time, the controls may bind or run out of travel. Decrease the travel until no binding occurs.

Winglet

[Corresponding model type]: Airplane/glider, winglet(2RUD)

This function adjusts the left and right rudder angles of airplanes with winglets.

It can be used for special airplanes with two rudders. The amount of movement of the two mounted rudder servos can be adjusted separately. Two servos are operated with one rudder stick.

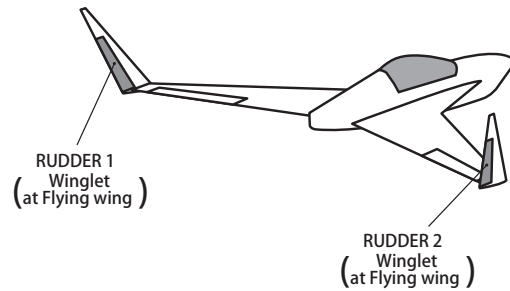

- Select [Winglet] at the model menu and call the setup screen shown below.

•Return to Model menu →

Condition group/
single mode
selection (Gr./Sngl)

(Rudder 1/2)
The travel at rudder stick left and right operation can be individually set.

- Travel adjustment
 - Tap to the item you want to adjust.
 - Adjust the rate using the "▼▼" "▼" "▲" "▲▲" buttons.
- *If the mixing direction is reversed by the linkage, adjustments can be made by changing the mixing rate polarity (+ or -).

GYA553 setting

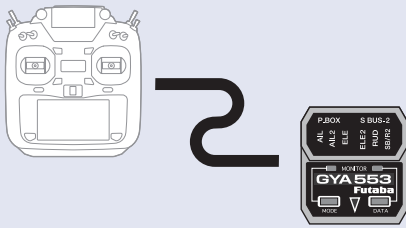

By connecting the T16IZ SUPER and the 6-axis gyro GYA553 for airplanes, you can set the GYA553.

Connection T16IZ SUPER and GYA553

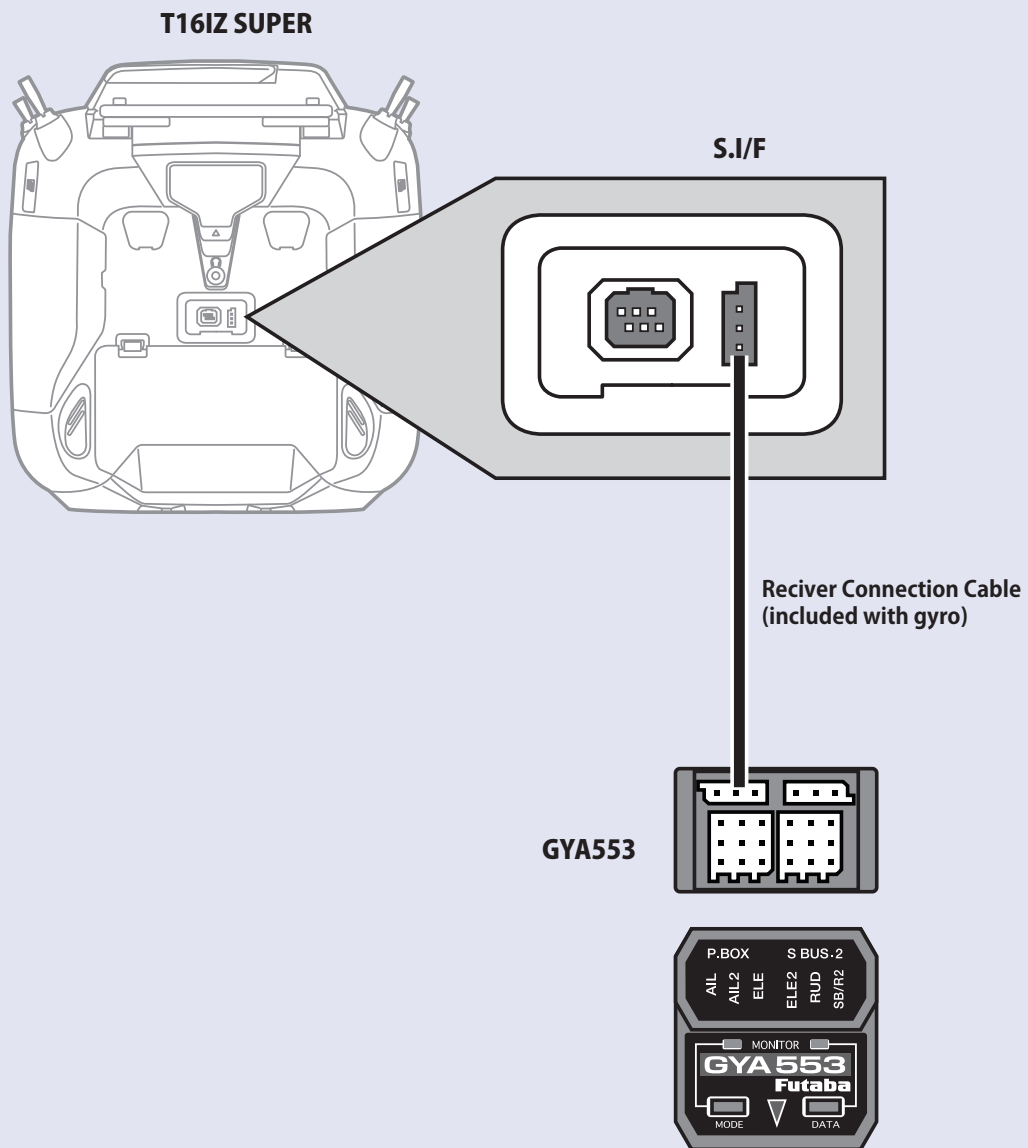

⚠ CAUTION

❗ Be sure to connect and disconnect the GYA553 and T16IZ SUPER connection cable with the power off.

Gyro setting GYA553

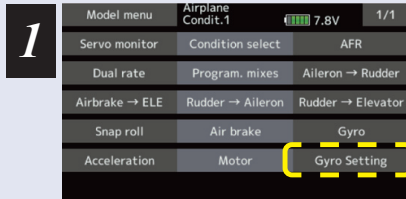

1. Select "Gyro setting" on the last page of Airplane Model Menu

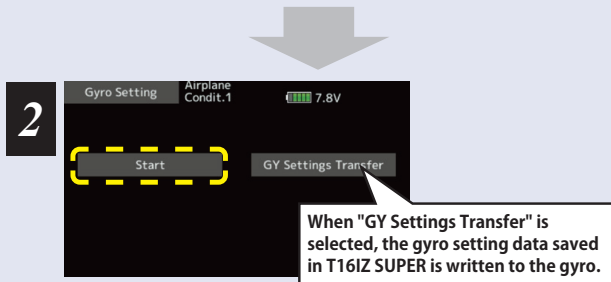

2. Select "Start"

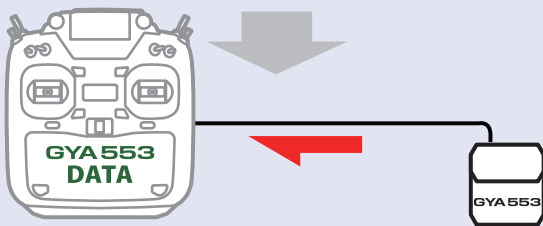
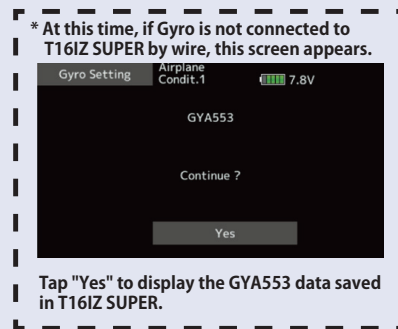

Select "Start"
This will download the gyro data to the T16IZ SUPER.

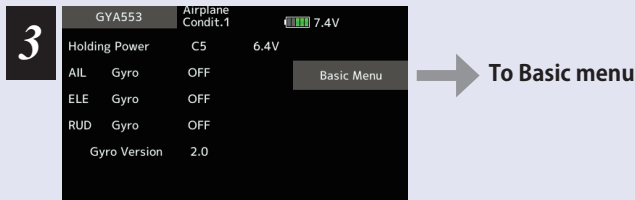

3. Home screen is displayed

◆ When copying data from Gyro A to Gyro B

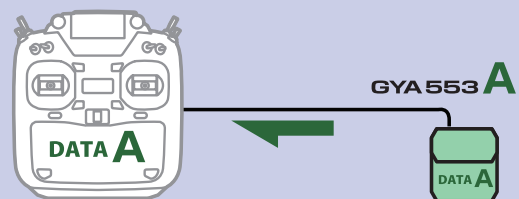

Connect the gyro A to the T16IZ SUPER and press [Start]. (Enter the data of A into T16IZ SUPER)



If you press Start here, the B data will be downloaded to the T16IZ SUPER and the A data will be lost.

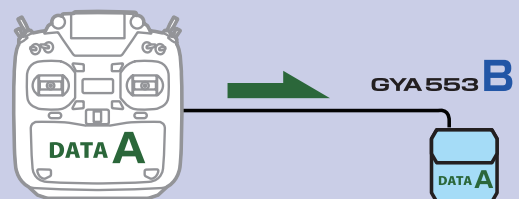

Connect Gyro B to T16IZ SUPER and press [GY Settings Transfer]. (Put data on A into gyro B)

Home screen

On the home screen, basic information such as gyro operation mode, sensitivity, battery voltage are displayed.

Gyro operation mode / Gyro gain

Displays "AVCS" or "Normal" operation mode and gyro gain of aileron (roll), elevator (pitch) and rudder (yaw) axis.

GYA553 Software version

The software version of the connected GYA553 is displayed.

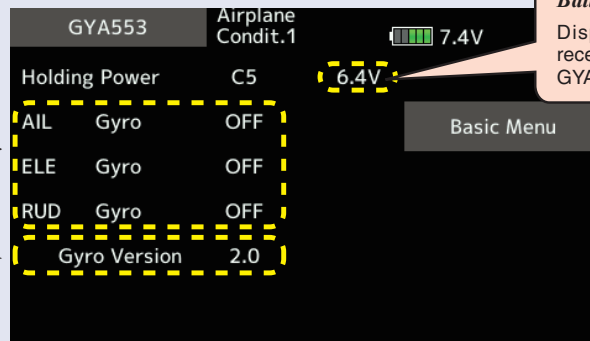

Battery voltage

Displays the voltage of the receiver battery connected to GYA.

Basic menu

Home screen

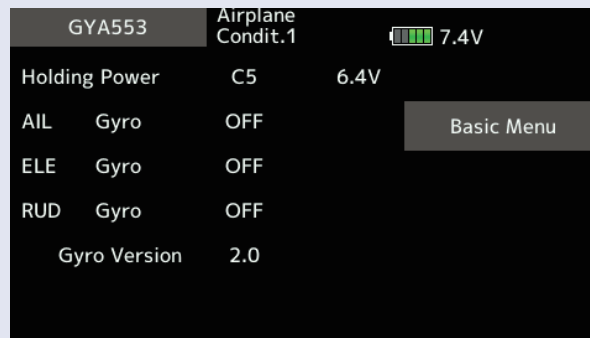

Basic menu

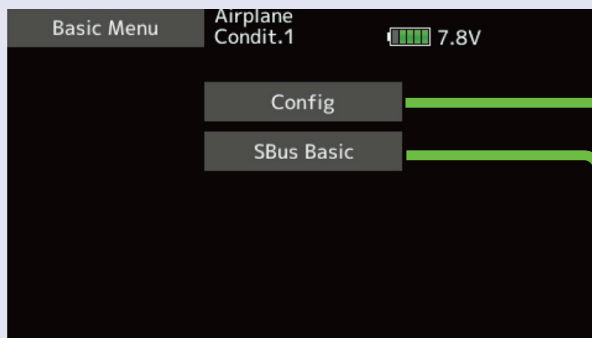

◆ Config

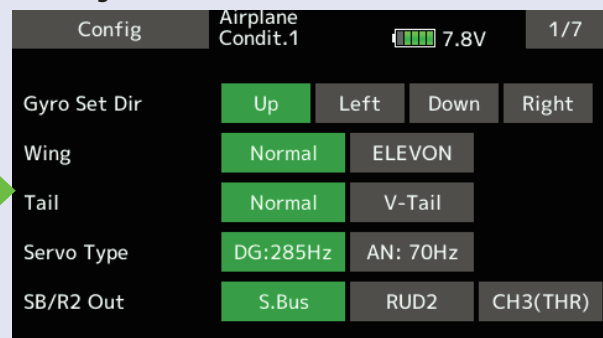

◆ S.BUS basic

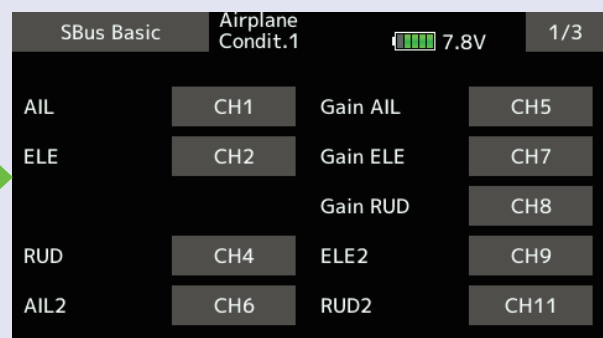

Config

Config 1/7 Gyro set mounting direction

Config	Airplane Condit.1	7.8V	1/7	
Gyro Set Dir	Up	Left	Down	Right
Wing	Normal	ELEVON		
Tail	Normal	V-Tail		
Servo Type	DG: 285Hz	AN: 70Hz		
SB/R2 Out	S.Bus	RUD2	CH3(THR)	

Set the mounting direction of GYA. Set mounting direction with reference to figure below.

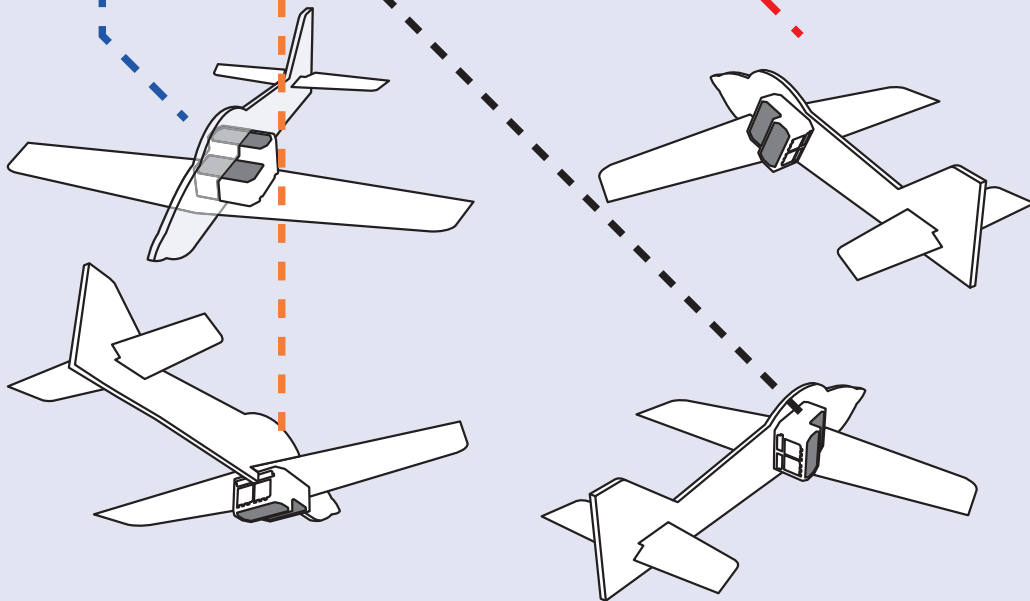

Config 1/7 WING/TAIL

Set with the wing type/tail type of GYA553. The wing type/tail type of the transmitter is not used and is normal.

- Turn off the elevon/V-tail mixing on the transmitter side.
- Do not use transmitter sub-trim. Adjust using the gyro neutral offset.
- When using the S.BUS servo, you can also use the neutral offset function of the S.BUS servo setting parameters.

Config	Airplane Condit.1	7.8V	1/7	
Gyro Set Dir	Up	Left	Down	Right
Wing	Normal	ELEVON		
Tail	Normal	V-Tail		
Servo Type	DG: 285Hz	AN: 70Hz		
SB/R2 Out	S.Bus	RUD2	CH3(THR)	

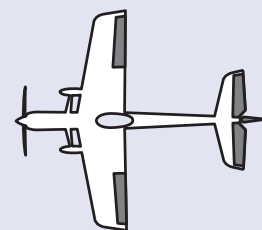

Select wing type

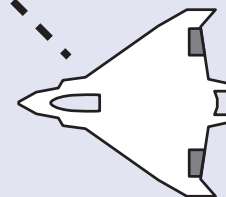

Select tail type



Config

Config 1/7 Servo type

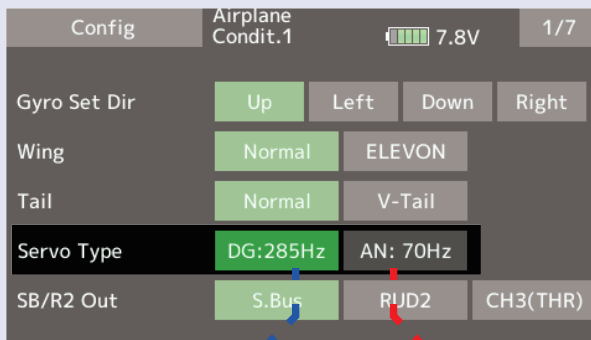

Digital servo

Analog servo

Select the servo type according to the servo to be used.

Digital servo → DG : 285 Hz

Analog servo → AN : 70 Hz

The stability of digital-servo mode of a flight increases in order to perform a high-speed control action.

Config 1/7 SB/R2 OUT

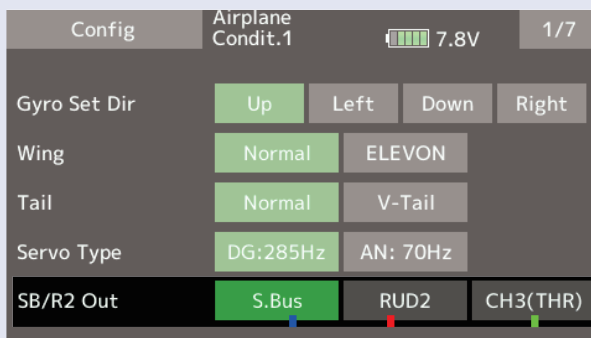

Select the SB/R2 port.

S.BUS

Rudder 2

Throttle

S.BUS devices can be connected to this port.



When using two rudder servos

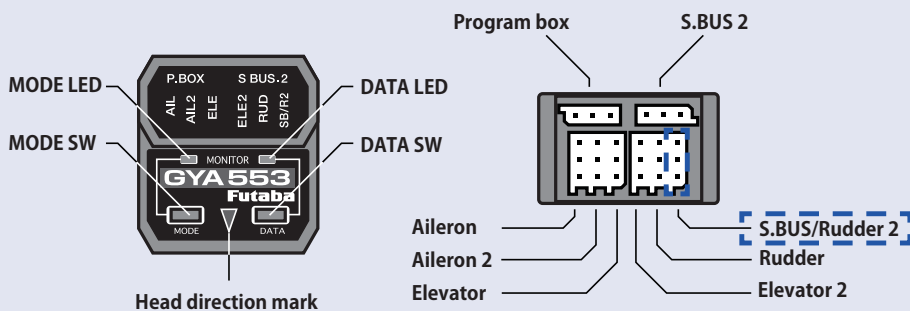

Config

Config 2/7 Gyro direction

It is the direction setting of the gyro. Be careful as it will crash if the direction is reversed.

For dual aileron, dual elevator, and dual rudder aircraft, check the operating direction of each second aileron/elevator/rudder.

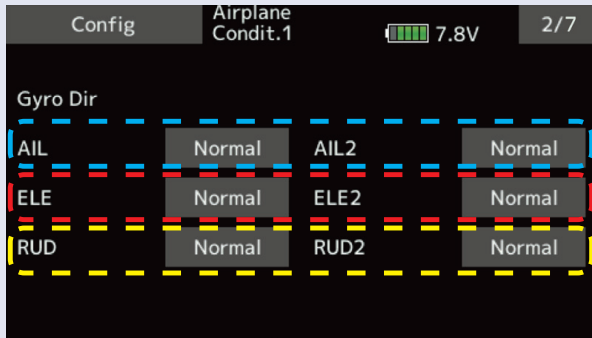

Tilt the airplane to the left on the ground and check that the ailerons operate to the right.

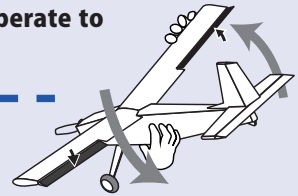

Turn the airplane to the right on the ground and check that the rudder operates to the left.

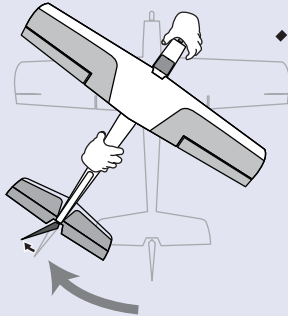

Raise the airplane with its nose upward and check that the elevator operates downward.

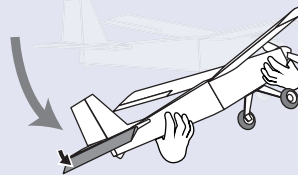

Config 3/7 Neutral offset

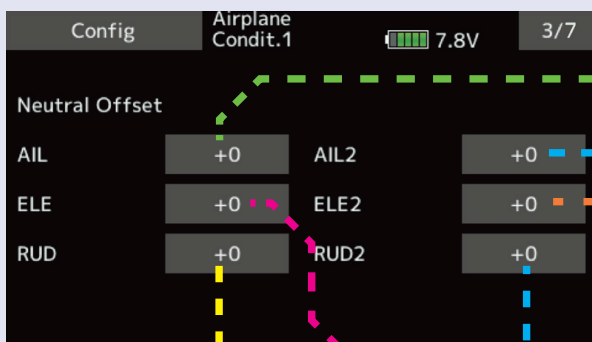

Neutral position setting for each servo.

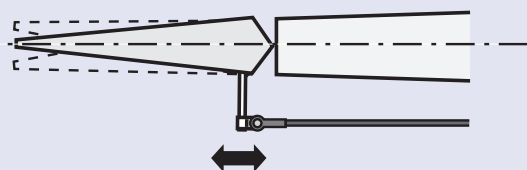
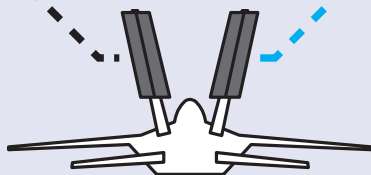
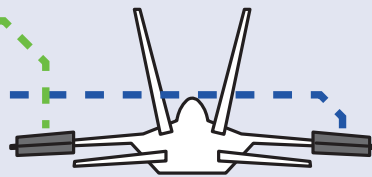

This will move the neutral to the desired position.

Config

Config 4/7 5/7 Servo limit

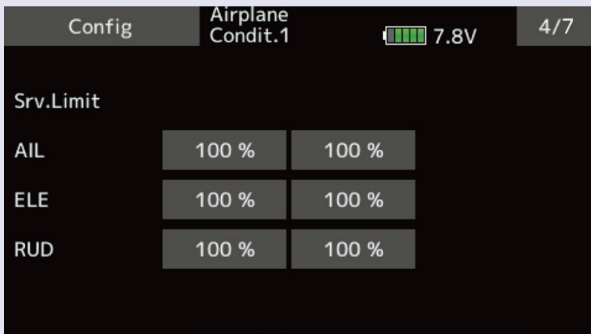

This is the limit setting for each servo. The position of the maximum operation is read into the gyro in the first setting.

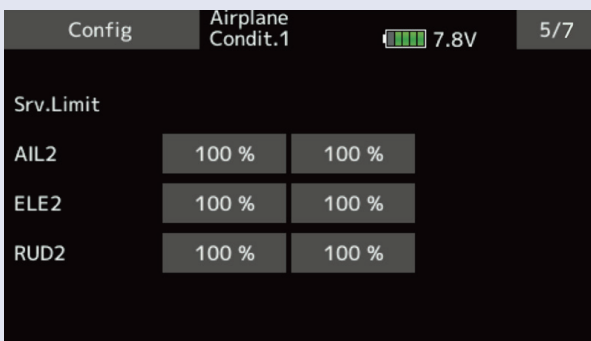

Aileron example

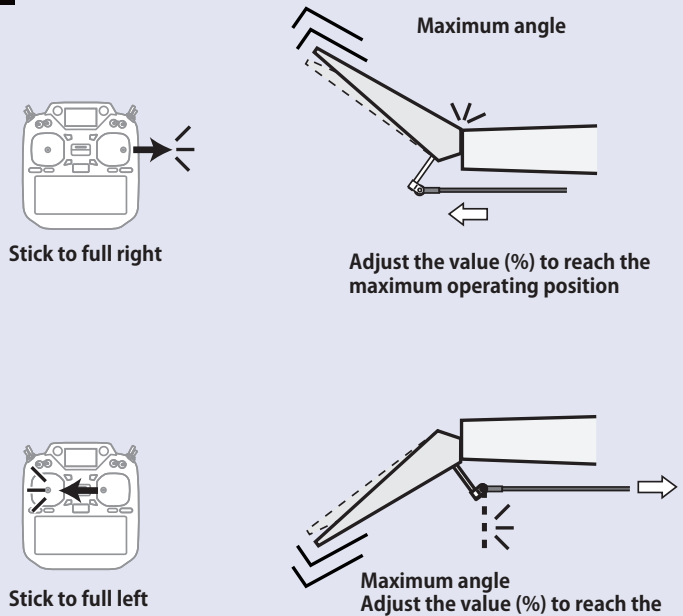

Config

Config 6/7 Holding Power

It is a function to adjust the posture holding force of the aircraft in AVCS mode. Decreasing the value weakens the holding power and makes the operation feeling closer to the normal mode.

The current rate numbers C1 to C5 are displayed by operating the channel of the transmitter.

Like the flight condition function of the transmitter, you can set up to 5 different data for the attitude holding force rate of the aircraft in AVCS mode by operating the switch from the transmitter, and switch between them. You can set the holding power rate selector switch to the channel with the AFR function of the transmitter, and set the point for each rate on the AFR point curve to switch. It is also possible to use the flight condition function to work with the flight condition switch.

Config 6/7

With the switch button, the "holding power" of each rate (C1 to C5) can be displayed and adjusted.

Display and adjust the current rate numbers C1 to C5 by operating the channel on the transmitter.

S.BUS Basic 2/3

By operating the channel of the transmitter, the channel position of the current rate numbers C1 to C5 will be displayed in green.

When set to SW of DG1 or DG2

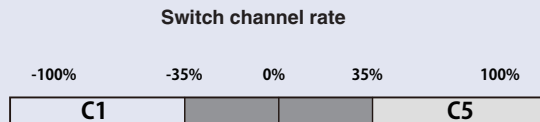
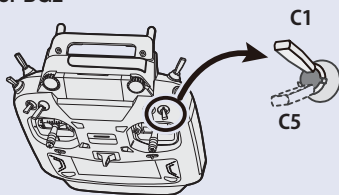

When set to dial or lever

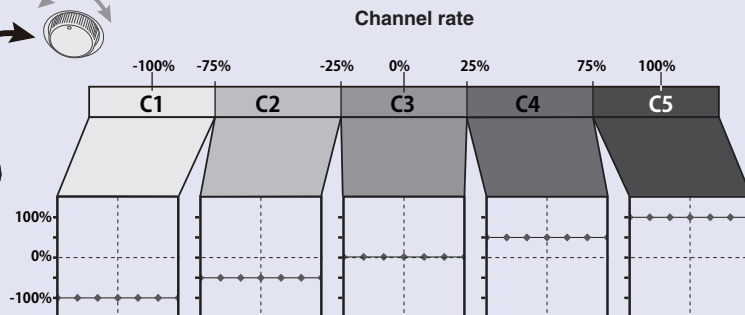
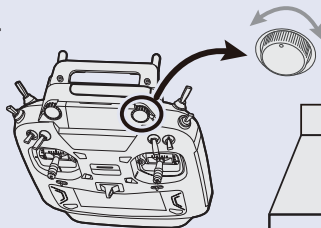

Config 7/7 Reset



Reset each Config item. It returns to the initial value.

SBUS Basic menu

Set the CH for each function according to the transmitter to be used. Any unused functions should be set to INH (Inhibited).



The channel of each function can be changed.

Tap to move to the rate switching CH setting page.

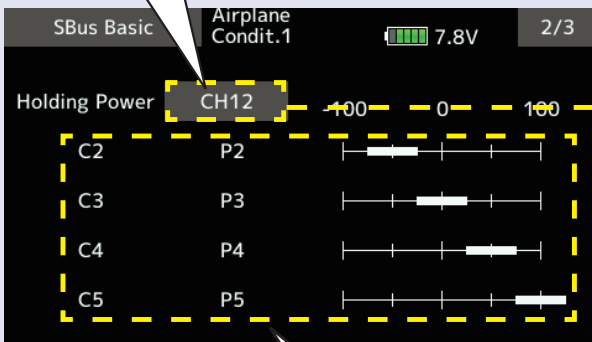

Holding Power C2 to C5

⚠ WARNING

Always verify that the S.BUS function assignments match your transmitter's function (in the FUNCTION menu) assignments. If any changes are made within the transmitter function assignments, then it will also be necessary to make the changes within the S.BUS function assignments. To change the channel, GYA553 and T16IZ SUPER must be connected.

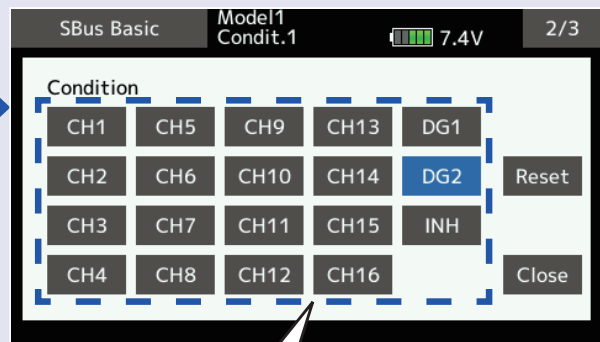

Tap the CH used for rate switching to select it.



Reset each S.BUS function. It returns to the initial value.

ON-OFF channel for auto recovery

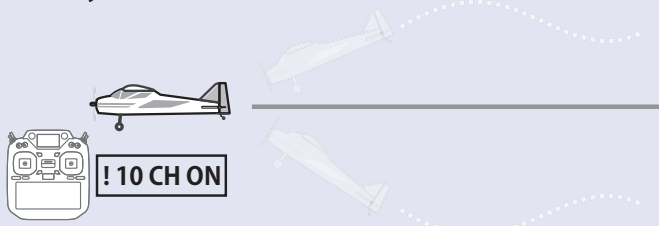

MODEL MENU (Helicopter functions)

This section contains information on the commands that apply to helicopters only. For instructions on airplane, glider and multicopter, refer to the sections pertaining to those aircraft.

Use the Model type function in the Linkage menu to select the swash type matched to the fuselage beforehand.

Also, add flight conditions at the Condition Select screen if necessary before setting the model data at each function. (Up to 8 conditions can be used)

The AFR function, dual rate function and other functions common to all model types, are described in a separate section.

◆ Condition hold

When performing adjustments, such as idling up, when the engine is engaged, keep the throttle stable so as to prevent the engine from revving too high. Once your adjustments are complete, always make sure to set the function to [OFF].

⚠ WARNING

! For safety reasons, when performing individual adjustments it is recommended that you shut off the engine and disconnect the motor to prevent rotation.

*Sudden, abrupt rotation can result in death or serious injury.

*Condition hold ON/OFF operation is possible under normal conditions and the throttle stick is more than 1/3rd into the slow throttle range. Throttle servos will remain at the throttle stick position during ON operation.

● ON/OFF operation on the Home screen

Under the conditions described above, tap the Condition hold [OFF] displayed on the screen.

During function operation, Condition hold will display [ON] and an alarm will sound.

Model menu (Helicopter) functions table

 Servo monitor	Displays the servo test and operation position
 Condition select	Flight conditions addition, deletion, copy, condition renaming, and condition delay can be set.
 AFR	Sets the angle and curve of all the operation functions.
 Dual rate	D/R curve which can be switched with a switch, etc. can also be added.
 Program. mixes	Program mixing which can be freely customized. Up to 10 mixes can be used for each condition.
 Pitch curve	Pitch curve and hovering trim adjustment
 Throttle curve	Throttle curve and hovering trim adjustment
 Acceleration	Allows a brief "overload" in response to sudden throttle and pitch commands
 Throttle hold	Moves the throttle to idle during autorotation
 Swash mixing	Compensates for each control response
 Throttle mixing	Compensates for power loss when cyclic applied
 Pitch → Needle	Adjusts response curve in different flight conditions
 Pitch → Rudder	Handles torque changes from pitch angle inputs
 Gyro	Used to switch gyro sensitivity
 Governor	Used to switch RPM of the helicopter's head
 Gyro setting	Detailed setting of CGY755/CGY760R

Condition select

Flight condition's addition, deletion, copy, condition renaming, and condition delay can be set. [All model types]

The functions in the Model menu can be used by switching the settings of up to 8 flight conditions by using the Condition select function to add flight conditions. Add conditions, as required.

When you do not want to use the Condition select function, this setting is unnecessary. In this case, use the flight conditions assigned at initial setting.

- Since switching by stick and lever position, in addition to ordinary toggle switch, is possible as the flight condition selector switch, this function can be linked with other operations.
- A Condition Delay function can be set. Unnecessary fuselage motion generated when there are sudden changes in the servo

positions and when there are variations in the operating time between channels during condition switching can be suppressed. The delay can be set for each channel.

When setting the delay function at the switching destination condition, the related function changes after a delay corresponding to the set amount.

- When multiple conditions were set, their operation priority can be freely changed.
- The condition name can be changed. The selected condition name is displayed on the screen. When a condition has been added, give it a name which can be easily confirmed.

- Select [Condition select] at the model menu and call the setup screen shown below.

Condition Renaming

1. Select the condition by tapping the condition you want to rename in Conditions List.
2. Tap the [Rename] button.
3. Enter the new name from the keyboard which appears on the screen.
4. When the keyboard [Condition name] key is tapped, the new name is registered.

Condition Addition

1. When the [Add] button is tapped, the Condition Select screen appears.
*Only the number of buttons corresponding to the conditions which can be added are displayed.
2. Select the desired conditions by tapping the buttons.
*The selected conditions are added to Conditions List.
3. Tap the [--] button to call the <Switch> screen.
4. Select the switch to be used in condition switching.
(See "Switch selection method" at the end of this manual for selection method details.)
5. The "Condition1" data for the added conditions is copied.

Condition Copy

1. Tap the [Copy] button. The Copy screen appears.
2. Select the condition by tapping the button of the copy source conditions.
3. Next, select the condition by tapping the copy destination condition.
4. Tap the [Copy] button.
5. When the [Yes] button is tapped, the data is copied. (To abort copying, tap the [No] button.)

Condition Remove

1. Select the condition by tapping the condition you want to reset in Conditions List.
2. Tap the [Remove] button.
3. When the [Yes] button is tapped, the condition is reset. (To abort resetting, tap the [No] button.)

Priority change

1. Tap the condition whose priority you want to change in Conditions List.
2. Change the priority with the priority [Δ] or [∇] button. (The last condition has the highest priority.)

*The initial setting condition cannot be moved. It has the lowest priority.

Condition delay setting

1. Switch to the condition you want to set.
2. Tap the Delay button of the channel you want to set.
3. Use the value input buttons to set the delay.
 - Initial value: 0
 - Adjustment range: 0~27 (maximum delay)

Ch	Function	Delay	
1	Aileron	0	Gr.
2	Elevator	0	Gr.
3	Throttle	0	Gr.
4	Rudder	0	Gr.
5	Gyro	0	Gr.
6	Gyro2	0	Gr.

AFR

The angle and curve of each operation function can be set. [All model types]

AFR function is used to adjust the throw and operation curve of the stick, lever, and switch functions for each flight condition.

This is normally used after End Point has defined the maximum throw. When mixing is applied from one channel to another channel, both channels can be adjusted at the same time by adjusting the operation rate through the AFR function.

- Operation curve adjustment: Three types of curves (EXP1, EXP2, and Point) can be selected. A maximum 17 points curve can be used for the point curve type. (Initial setting: 9 points) The number of points can also be increased and decreased and curves from complex curves to simple curves can be used.
- Operation speed adjustment: The operation speed of each function when the function is operated (including at flight condition switching) can be adjusted. The function operates smoothly at a constant speed corresponding to the set speed.

When D/R is turned ON, the display will show "D/R----", and the rudder angle (rate) and EXP can be set when D/R is ON.

- Select [AFR] at the model menu and call the setup screen shown below.

Return to Model menu

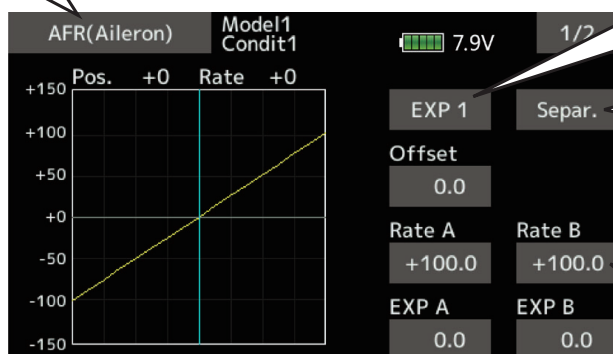

Curve select EXP1, EXP2, Point curve

Curve select Separately ⇔ Combination (Left and right symmetrical curve.)

Left/right, Up/down, overall adjustment at Rate A and Rate B

● Operation curve setting (For a description of the setting method, see the description at the back of this manual.)

Function selection

1. When the function select button is tapped, a selection screen appears.
2. Select the function you want to set at the selection screen.

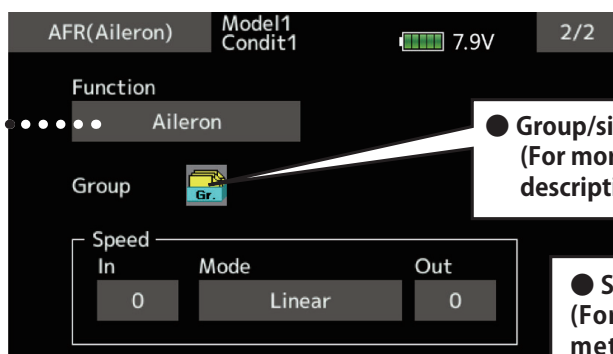

● Group/single mode switch (Gr./Sngl) (For more information, see the description at the back of this manual.)

● Servo speed setting (For a description of the setting method, see the description at the back of this manual.)

Dual rate

D/R curves which can be switched by switch, etc. can be added. The curve can be adjusted by the AFR function.

- Up to 6 rates can be added for each condition.
- D/R is set for each condition and is not reflected at other conditions.
- D/R at the top of the D/R list has priority.

- Select [Dual rate] at the model menu and call the setup screen shown below.

•Return to Model menu

Dual rate		Model1 Condit1	7.9V	
	Status	Function	Switch	
1	D/R 1	INH	Aileron	SD
2	D/R 2	INH	Elevator	SA
3	D/R 3	INH	Rudder	SB
4	D/R 4	INH	Aileron	--
5	D/R 5	INH	Aileron	--
6	D/R 6	INH	Aileron	--

The ON/OFF switch of dual rate is chosen.

Activate the D/R function by tapping the [INH].

When the function select button is tapped, a selection screen appears. Select the function you want to set at the selection screen.



● **Setting rudder angle, EXP**
On this D/R screen you can set functions and switchover switches. Rudder angle (rate) and EXP settings are performed on the AFR screen when the D/R switch is ON.

Program. mixes

Program mixing which can be freely customized. Up to 10 mixings can be used for each condition. [All model types]

Programmable mixing may be used to correct undesired tendencies of the aircraft, and it may also be used for unusual control configurations. Mixing means that the motion of a command channel, called the "master," is added to the motion of the mixed channel, called "slave."

You may choose to have the Masters trim added to the Slave channel response, if you desire ("Trim" setting). The mixing curve can be changed so that the undesired tendencies can be corrected effectively by setting the EXP1/EXP2/Point modes.

Offset-type mixing applies a fixed offset or preset to the programmed channel servo operation and may control up to four circuits simultaneously.

The Programmable mixing includes a powerful link function, which allows Programmable mixing to be linked with the special mixing functions, or with other programmable mixing functions. The link function can be set up for Master and Slave channel individually.

- Tap the [Prog. mixes] button in the Model menu to call the setup screen shown below.

•Return to Model menu →

Channel	Mixing	Mode	Gr.
1	Inhibit	Offset	Gr.
2	Inhibit	Mixing	Gr.
3	Inhibit	Mixing	Gr.
4	Inhibit	Mixing	Gr.
5	Inhibit	Mixing	Gr.

● **Group/single mode switch (Gr./Sngl)**
(For more information, see the description at the back of this manual.)

After this function is activated, the master and slave function names (or offset mixing) are displayed.

Mixing/Offset mode switch

● **Operation curve setting**
(For a description of the setting method, see the description at the back of this manual.)

Activate the function by tapping the [INH].

The ON/OFF switch of prog. mixes is chosen.

Master function (or Stick, Switch, Dial) is chosen.

Slave function is chosen.

Servo speed setting

Trim mode setting ON/OFF.

Fine tuning trim setting

The on time (start/stop time) can be set up to 4 seconds. It is useful for landing gear control of the jet or scale plane, etc.

Setting methods

●Group/single mode selection

Activating functions for only the selected conditions:

1. Tap the [Gr] button and switch to the [Sngl] mode.

*Each time the button is tapped, it toggles between the Gr and Sngl modes.

●Mixing mode selection

Using the offset mode:

1. Tap the Mode button and switch to the Offset mode.

*Each time the button is tapped, it toggles between the Mixing and Offset modes.

●Mixing setup screen selection

1. Tap the button of the mixing you want to set. The mixing setup screen is displayed. Activate the function.

2. Activate the function by tapping the [INH] button.

*Each time this button is tapped, it toggles between [INH] and [ON/OFF].

●Mixing ON/OFF switch setting and ON/OFF direction switching

*An ON/OFF switch is not set even when the function is activated.

1. When you want to turn mixing ON/OFF by switch, tap the [--] button to call the <Switch> screen and then select the switch and its ON direction.

*For a description of the selection method, see [Switch setting method] at the back of this manual.

●Master channel setting (except offset type mixing)

1. Tap the Master button to call the Function menu and select the master channel.

2. To link this mixing with other mixing, tap the "Link" button.

*Each time the button is tapped, it toggles between mixing direction + and - and "OFF" (no link).

*Master channel control can be set to stick, VR, and other simple travels which do not include End point, AFR, D/R, mixing setting, etc. In this case, display the <Function,H/W> screen by tapping the [Stick, Switch, Dial] button and then select master channel side control.

●Slave channel setting

1. Tap the Slave button to call the Function menu and select the slave channel.

2. To link this mixing with other mixing, tap the "Link" button.

*Each time the button is pressed, it toggles between mixing direction + and - and "OFF" (no link).

●Trim mode ON/OFF setting

1. To turn the trim mode ON/OFF, tap the Trim button on the screen.

*When mixing includes master side trim, set the Trim button to [ON]. When mixing does not include master side trim, set the Trim button to [OFF].

*Each time this button is pressed, it toggles between [ON] and [OFF].

*This is effective when the master channel is set by Function.

●Mixing curve type selection

1. Tap the curve type selection button of the curve type you want to use to display the selection screen. Then, select the curve you want to use.

*For a description of the curve setting method, see the description at the back of this manual.

●Fine tuning trim setting

1. When using the curve fine tuning function, tap the [--] button of the Fine Tuning item to call the <Switch> screen and then select the lever, VR, etc. you want to use.

*For a description of the fine tuning trim setting method, see the description at the back of this manual.

●Servo speed setting

1. When setting the servo speed, tap the speed button. The Servo speed setup screen is displayed.

*For a description of the servo speed setting method, see the description at the back of this manual.

*Offset mixing changes the speed. Use the Speed In and Speed Out buttons to readjust the speed.

The mixing switch can set a delay with a different rate at starting and stopping.

*This function is inactive when a mixing switch is not set.

Pitch curve / Pitch trim

Pitch curve

This function adjusts the pitch operation curve for each flight condition for the optimal flight state relative to movement of the throttle stick.

*Up to 17 points can be set for the point curve types. However, when using the 3 points or 5 points specified to create a curve, a simple curve can be created by reducing the number of input points to 3 or 5, and then entering the specified value at the corresponding points that you created a curve.

- Select [Pitch curve] at the model menu and call the setup screen shown below.

- Return to Model menu

Currently selected condition name

● Mixing curve setting

*For a description of the curve setting method, see the description at the back of this manual.

Point curve type is 9 points (initial), but for simple use, 4~5 points are sufficient.

Normal curve adjustment

- For normal curve, usually use [Point] type and create a basic pitch curve centered about hovering. Use this function together with the THR curve (normal) function and adjust the curve so that up/down control is best at a constant engine speed.

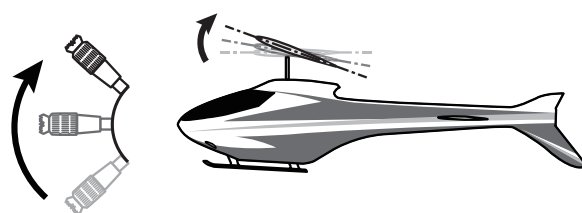

Idle up curve adjustment

- For the high side pitch curve, set the maximum pitch which does overload the engine. For the low side pitch curve, create curves matched to loop, roll, 3D, and other purposes and use the idle up curves according to the performance.

Throttle hold curve adjustment

- The throttle hold curve is used when executing auto rotation dives.

Operation precautions

⚠ WARNING

- ! When actually starting the engine and flying, always set the idle up condition switch to OFF and start the engine in the idling state.

Setting method

- Group/Single item: When you also want to input the same setting contents at other conditions, perform setting in the group mode. In this case, the same contents are input to the other conditions set in the group mode. When you want to set each condition independently, select the single mode (initial setting). Other conditions can be set independently.

Curve setting examples

The screens shown below are curves created by entering the pitch rate at low, center, and high side (3 points or 5 points) at each condition. When actually creating a curve, input the rate specified at the fuselage (or the reference value).

*For a description of the curve setting method, see the description at the back of this manual.

•Pitch Curve (Example)

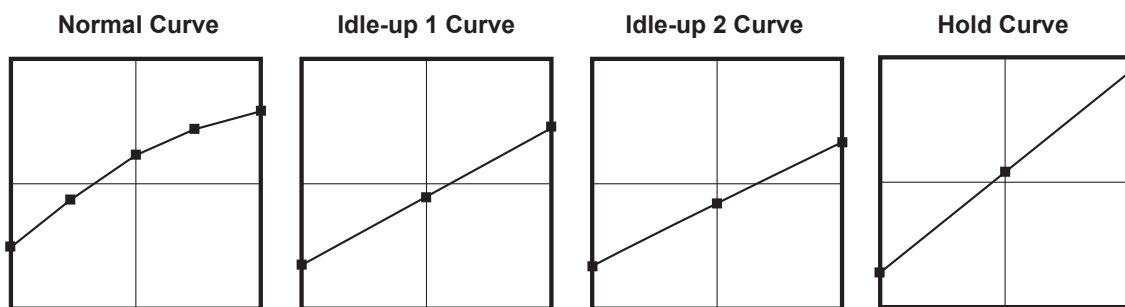

Pitch servo speed setting
(For a description of the setting method, see the description at the back of this manual.)

Pitch trim (Hovering pitch, high pitch, low pitch)

The hovering pitch, low pitch, and high pitch trim setup screen can be called from the Pitch curve setup screen.

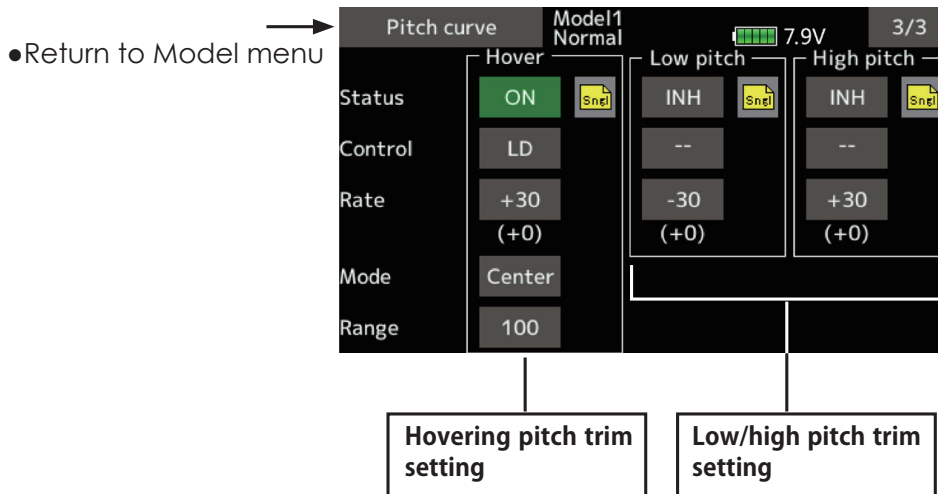

Hovering pitch trim

The Hovering Pitch trim function trims the pitch near the hovering point. Normally, it is used with the hovering condition. The hovering pitch can be fine tuned for changes in rotor speed accompanying changes in temperature, humidity, and other flight conditions. Adjust the hovering pitch so that rotor speed is constant. This function can be used together with the hovering Throttle Trim function for more delicate operation.

Setting method

- When using only the hovering (normal) condition, switch the group mode to the single mode (initial setting) before setting.
- Tap [INH]. (ON is displayed.)
- Select the adjustment knob.
Selection example: LD
- The trim operation mode (Mode: Center/Normal) can be selected.
Center mode: Maximum amount of change near center by center trim operation (recommended)
Normal mode: Normal trim (parallel movement trim) operation. The advantage of using this mode is that the hovering pitch can be adjusted without changing the curve.
- Trim adjustment range (Range) setting
When this value is made small, trim can only be used near the center.
- The trim rate can be adjusted and the operation direction can be changed.

High Pitch/Low Pitch Trim

High Pitch/Low Pitch Trim is the pitch servo high side and low side trim function.

Setting method

- When setting the adjustment knobs common to all the conditions, set them in the group mode.
- Tap [INH]. (ON is displayed.)
- Select the adjustment knobs.
Selection example: LS (high side), RS (low side)
- The trim rate can be adjusted and the operation direction can be changed.
- Trim acts as high side or low side trim with the center as the standard.

Throttle curve / Throttle Hover trim

Throttle curve

This function adjusts the throttle operation curve for each condition for optimum engine speed to throttle stick movement.

Up to 17 curve points can be set for the point curve type. However, when the 5 points and other

point data is used, a simple curve can be easily created by reducing the number of input points of the curve to 5 and entering the specified value at the corresponding points.

- Select [Throttle curve] at the model menu and call the setup screen shown below.

- Return to Model menu

● **Mixing curve setting**
*For a description of the curve setting method, see the back of this manual.

Throttle hover trim operating position (White line)

Point curve type is 9 points (initial), but for simple use, 4~5 points are sufficient.

Normal curve adjustment

- Normal curve creates a basic curve centered around hovering. Use it along with the normal pitch curve and adjust so that up/down control at a constant engine speed is easiest.

Idle up curve adjustment

- Set an idle up curve that maintains a constant speed at all times, even during operation which reduces the pitch performed in flight. Create a curve matched to loop, roll, 3D, or other purposes and the idle up curve according to the performance.

Operation precautions

⚠ WARNING

- ❗ When actually starting the engine and flying, always set the idle up condition switch to OFF and start the engine in the idling mode.

Setting method

- Group/single item: When you want to simultaneously enter the same settings to other functions, make the settings in the group mode. In this case, the same setting

contents are entered to the all conditions. When you want to set each condition independently, make the settings after selecting the single mode (Initial setting).

Curve setting examples

The curves shown below are created by using the point curve type and inputting the data of the 5 points 0% (low side), 25%, 50% (center), 75%, 100% (high) side at each condition. They are

created by reducing the number of points on the line to 5. When actually creating a curve, enter the data specified per the aircraft (or the reference value).

*For a description of the curve creation method, see the description at the back of this manual.

●Throttle Curve (Example)

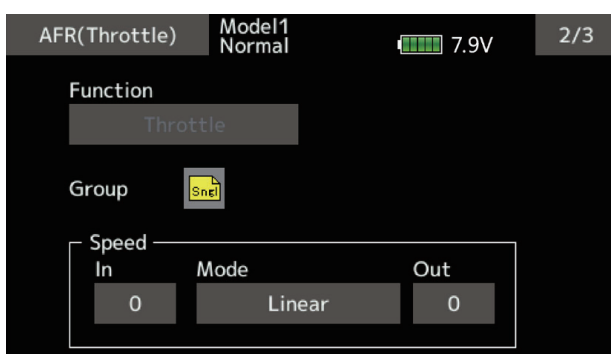
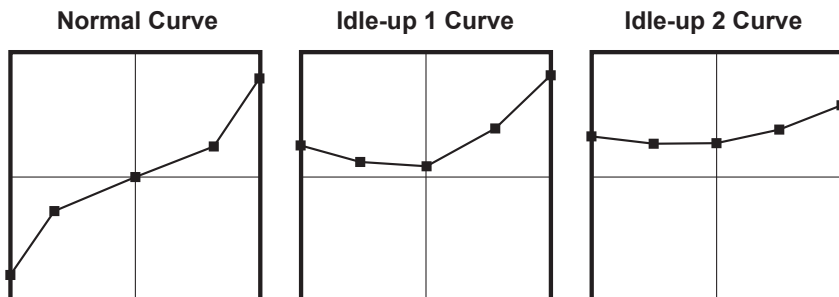

Throttle servo speed setting
(For a description of the setting method, see the description at the back of this manual.)

Throttle Hover trim

The Throttle Hover trim setup screen can be called from the Throttle curve setup screen.

- Return to Model menu

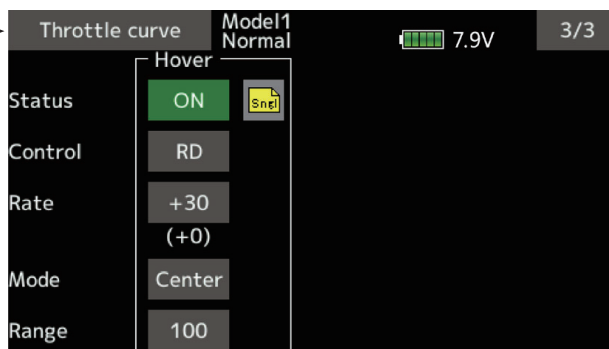

The Throttle Hover function trims the throttle near the hovering point. Normally, use it with hovering conditions. Changes in rotor speed accompanying changes in the temperature, humidity, and other flight conditions can be trimmed. Adjust the throttle so that rotor rotation is most stable. More delicate trimming is also possible by using this function along with the Hover Pitch function.

Setting method

- When using the hovering (normal) condition only, switch the group mode to the single mode (initial setting) and make the settings.
- Tap [INH]. (ON is displayed.)
- Select the adjustment knob.
Selection example: RD
- The trim operation mode (Mode: Center/Normal) can be selected.
Center mode: Maximum rate of change near center by center trim operation (recommended)
Normal mode: Normal trim (horizontal movement trim) operation.
- Trim adjustment range (Range) setting
When the value is made small, trim acts only near the center.
- The trim rate can be adjusted and the operation direction can be set.

Acceleration

This function is used to adjust the pitch and the throttle rise characteristic at acceleration/deceleration operation. An acceleration function which temporarily increases the pitch and throttle operations at throttle stick acceleration/deceleration operation can be set.

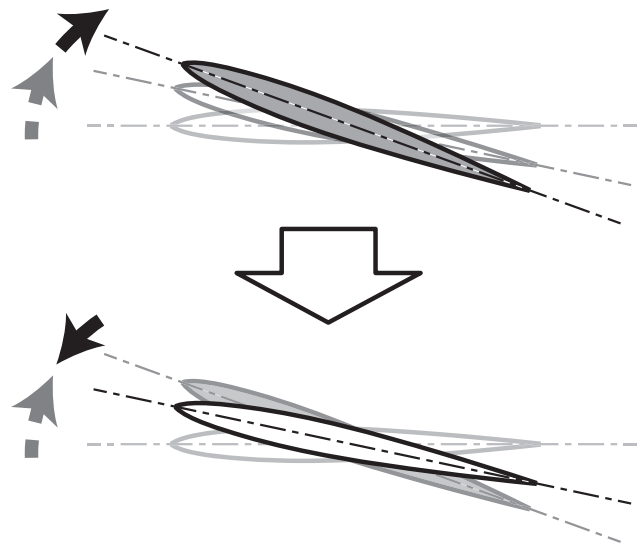

Example of acceleration function use

- When used at pitch, the acceleration function is effective when you want to quicken the response of the fuselage at 3D flight flip, etc.
When used, high pitch temporarily exceeds maximum pitch, but immediately returns to maximum pitch.

- Select [Acceleration] at the model menu and call the setup screen shown below.

When using this function, Tap [INH]. (ON is displayed.)

Condition group/ single mode selection (Gr./Sngl)

**To next page
1/2 : Pitch
2/2 : Throttle**

Operation up to this range will initiate acceleration.

Act position

Current position

The rate the angle increases.

**The return time after operation (Damping) can be set.
(First return) 1 ~ 100 (Slow return)
(Acceleration doesn't function as 0.)**

Setting method

- Acceleration can be set at both setting at acceleration (high) and setting at deceleration (low).
(The operation point is displayed on a graph.)
- Acceleration rate setting (Rate)
- The return time after operation (Damping) can be set.
- The operation point at acceleration and deceleration can be set. When an operation point is exceeded, acceleration is performed.

Note: When using the acceleration function, since the pitch stroke is large, make your settings so there is no binding of your linkage.

Throttle hold

This function sets the throttle cut position for autorotation. The throttle position can also be set to an idling position. Setting of these 2 positions can be selected by switch. This allows use for switching during training.

- Select [Throttle hold] at the model menu and call the setup screen shown below.

• Return to Model menu

Mode	Status	Switch	Hold pos.	Speed	Mode	Auto pos.
Cut mode	INH	--	17	0	Manual	50
Idle mode	INH	--	50	0	Manual	50

Labels in image:
 - Current position (points to slider)
 - Set to the engine stop position. (points to Cut mode Hold pos.)
 - Hold position (points to Idle mode Hold pos.)
 - Engine cut setting (points to Cut mode section)
 - Engine idle setting (points to Idle mode section)
 - Set to the idling position. (points to Idle mode Hold pos.)

Example of use

- Since throttle hold has 2 modes (Cut) and (Idle), using it in the Idling mode during training and in the Cut mode when stopping the engine at contest, etc. is convenient.

Note: When throttle hold is set to ON in the normal condition, throttle hold acts and the throttle servo is deactivated. Always set throttle hold to ON in the hold condition.

Setting method

- Operation mode selection
 Manual mode(Manual): The throttle hold function is operated by switch operation only.
 Auto mode(Auto): The throttle hold operation is linked to the throttle stick position.
 Auto position setting: When the auto mode is selected, the throttle position (auto position) can be selected. Move the throttle stick to the position you want to set and tap the screen. (Auto position is displayed.)
- Hold position adjustment
 Throttle Hold (Cut) sets the throttle cut position. Adjust it so that the carburetor is fully closed.
 Throttle Hold (Idle): Make this adjustment to maintain idling for training. Adjustments can be made based on the throttle curve idle position.
- The throttle servo operating speed can be adjusted. (Speed)
- Throttle cut or training function can be switched by hold function selector switch.

Operation precautions

⚠ WARNING

- ❗ When starting the engine, confirm that the idle up condition and throttle hold condition are OFF.

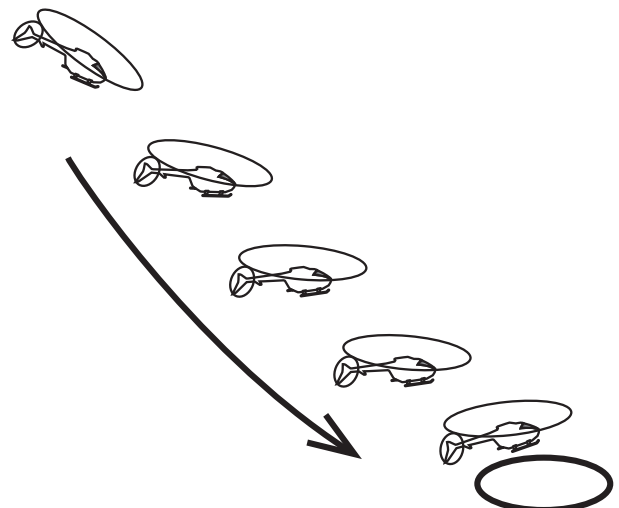

Swash mixing

The swash mix function is used to correct the swash plate in the aileron (roll) direction and elevator (cyclic pitch) corresponding to each operation of each condition.

Adjustment by independent curve for aileron, elevator, and pitch operations is possible. The operation can be smoothly adjusted by calling up the “Curve setup” screen by tapping the mixing item that corresponds to the mixing and direction which needs correction.

Example of use

- As an example, use swash mixing to correct undesirable tendencies in the roll direction.
- For a condition which uses Aileron to Elevator, set this function to ON. When raising the nose at a right roll, when the Rate B side is input and the right aileron is operated, the elevator moves to the down side. Tune by adjusting the Rate. For right roll, adjust to the rate A side.

- Select [Swash mixing] at the model menu and call the setup screen shown below.

- Return to Model menu

● Mixing curve setting
 *For a description of the curve setting method, see the description at the back of this manual.

Setting method

- When using this function, Tap [INH]. (ON is displayed.)
- When you want to set the same contents at other conditions, select the group mode. When you want to set the selected condition only, select the single mode (initial setting).
- The correction rate can be set by curve.
- A switch can be set.

When [--] is set, the swash mixing function is operated by merely selecting the condition.

When setting an [ON]/[OFF] switch, tap to the [--] item and tap the screen to call the selection screen and set the switch and its ON position.

Throttle mixing

This function corrects slowing of engine speed caused by swash plate operation during aileron or elevator operation. The method of applying clockwise or counterclockwise torque when pirouetting can also be corrected.

An acceleration function which temporarily increases the throttle side correction rate relative to rapid stick operation can also be set.

- Select [Throttle mixing] at the model menu and call the setup screen shown below.
- Return to Model menu

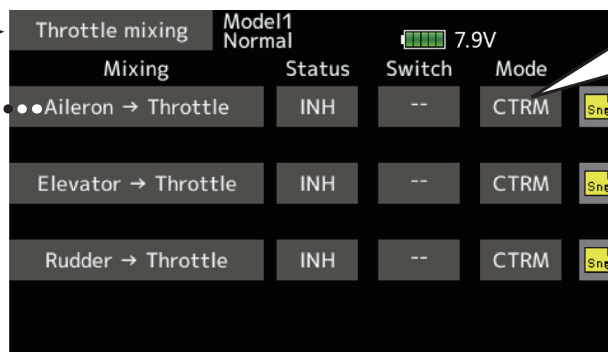

"CTRM" : The correction rate maximum when the throttle stick is centered.
 "Linear" : Correction applied for the entire throttle range.

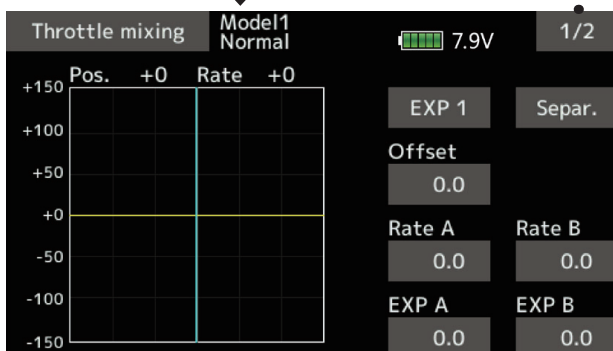

● **Mixing curve setting**
 *For a description of the curve setting method, see the description at the back of this manual.

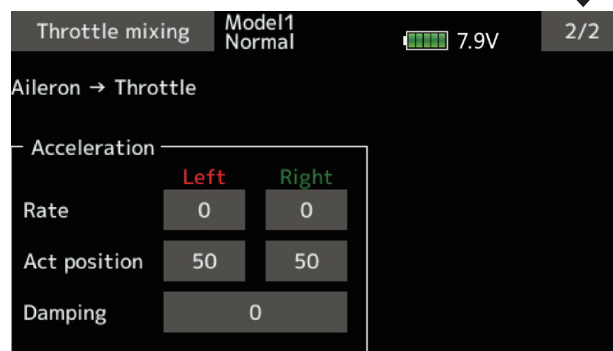

<Acceleration function setting>

- Acceleration can be set for both settings (Left) and (Right)
- Acceleration rate setting (Rate)
- The return time (Damping) after operation can be set.
- The operation point (Act position) when the correction rate is increased and decreased can be set independently. When an operation point is exceeded, acceleration operation is performed.

Setting method

- When using this function, Tap [INH]. (ON is displayed.)
- When you want to set the same contents at other conditions, select the group mode. When you want to set the selected condition only, select the single mode (initial setting).
- The correction rate can be set by curve.
- A switch can be set. When [--] is set, the swash mixing function is operated by merely selecting the condition. When setting an [ON]/[OFF] switch, tap to the [--] item and tap the screen to call the selection screen and set the switch and its ON position.

When correction is necessary, tap to the mixing item corresponding to the mixing that needs correction and tap the screen to call the curve setup screen, and then correct the slowing.

Setting example

- Aileron to Throttle applies a load to the engine and corrects slowing of the engine speed when the aileron stick was operated. Engine racing can be adjusted independently at the right aileron and left aileron by Rates A and B.

Pitch → Needle

This mixing is used when the engine is equipped with needle control or other fuel-air mixture adjustment. A needle curve can be set.

An acceleration function which temporarily

increases needle operation at throttle stick acceleration/deceleration operation can be set. The rise characteristic of the needle servo at acceleration and deceleration operation can be adjusted.

- Select [Pitch→Needle] at the model menu and call the setup screen shown below.

- Return to Model menu

● **Mixing curve setting**
*For a description of the curve setting method, see the description at the back of this manual.



Normally, use [Point] type.

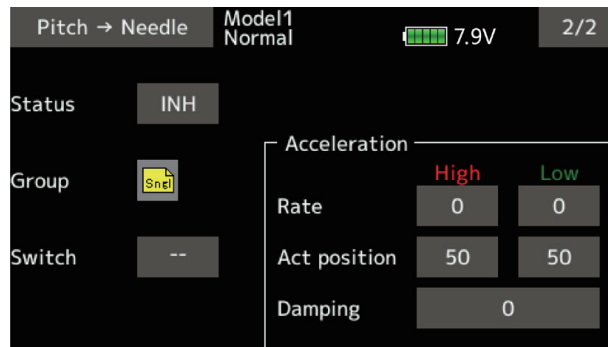

Setting method

- When using this function, Tap [INH]. (ON is displayed.)
- When you want to set the same contents at other conditions, select the group mode.
When you want to set the selected condition only, select the single mode (initial setting).
- A needle curve can be set.
- A switch can be set.

When [--] is set, the mixing function is operated by merely selecting the condition.

When setting an [ON]/[OFF] switch, tap to the [--] item. Tap the screen to call the selection screen and set the switch and its ON position.

< Acceleration function setting >

- Acceleration can be set at both acceleration (high) and deceleration (low).
- The acceleration rate (rate) and the return time after operation (damping) can be set.
- An operation point (Act position) at acceleration and deceleration can be set. When an operation point was exceeded, acceleration operation is performed.

Pitch → Rudder (Revolution mixing)

Use this mix when you want to suppress the reaction torque generated by main rotor pitch and speed changes during pitch operation. Adjust so that the nose does not move in the rudder direction.

An acceleration function which temporarily increases the correction rate at throttle stick acceleration/deceleration operation can be set. The mixing rate at acceleration/deceleration can be set.

- Select [Pitch→Rudder] at the model menu and call the setup screen shown.

● **Mixing curve setting**
 *For a description of the curve setting method, see the description at the back of this manual.



Normally, use [Point] type.

Setting method

- When using this function, Tap [INH]. (ON is displayed.)
- When you want to set the same contents at other conditions, select the group mode.
 When you want to set the selected condition only, select the single mode (initial setting).
- A mixing curve is set.

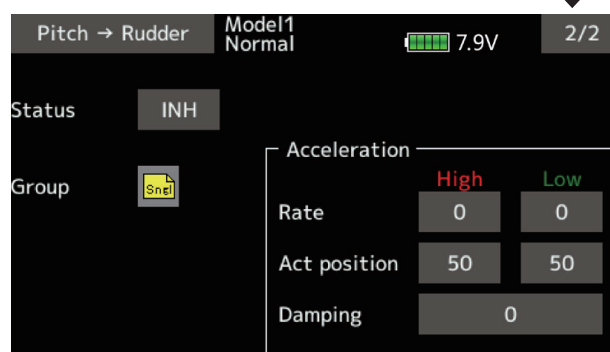

<Normal condition mixing curve>

The mixing curve rate starts from a small value.

For a rotor with a clockwise operation direction (polarity), when pitch was operated at the plus side, set so that mixing is in the clockwise direction. First, trim at hovering and then adjust the neutral position.

1. Adjustment between slow and hovering
 Repeatedly hover from take off and land from hovering at a constant rate matched to your own rhythm, and adjust the pitch so the nose does not deflect when the throttle is raised and lowered.
2. Throttle high side (climbing and diving from hovering)
 Repeat climbing and diving from hovering at a constant rate matched to your own rhythm and adjust the pitch so that the nose does not deflect when the throttle is raised and lowered.

<Idle up condition mixing curve>

Set the mixing rate so that the rudder direction at high-speed flight is straight ahead. Adjust for each condition used.

<Acceleration function setting>

- Acceleration operation can be performed for both setting at acceleration (High) and setting at deceleration (Low).
- Acceleration rate setting (Rate)
- The return time after operation (Damping) can be set.
- An operation point (Act position) at acceleration and deceleration can be set independently. When an operation point was exceeded, acceleration operation is performed.

Gyro [Helicopter]

This function is used to adjust gyro sensitivity. The sensitivity and operation mode (Normal mode/AVCS mode) can be set for each condition.

The gyro sensitivity can be switched with each condition or the switch. (3 sensitivities)

*Compatible with 3 axis gyro (CGY750).

Note: [Gyro] [Gyro2] [Gyro3] Default function [Gyro]: **CH6**(FASSTest12CH) **CH5**(Other system type)

[Gyro2] : **CH9**

[Gyro3] : **CH10**

Always set to [--] both (control) and (trim) for the [Gyro] function at the Function menu in the Linkage menu.

- Select [Gyro] at the model menu and call the setup screen.
- Return to Model menu

The operation mode (AVCS/NOR) and sensitivity of the 3 axes Gyro/Gyro2/Gyro3 can be set.

Tapping these will pull up the detailed selection screen for each.

Rate1 Gyro type and gain

Rate2 Gyro type and gain

Rate3 Gyro type and gain

When using Rate2/Rate3, make it INH → ON or OFF.

Condition group/single mode selection (Gr./Sngl)

The ON/OFF switch of gyro is chosen.

3 rate (gyro gain) adjustment

Use this when you want to adjust sensitivity via VR, etc., and not on-screen data entry. Tap "--", select "VR", etc., and then tap the value to adjust. (Won't operate when value is "0".)

	Gyro (RUD) setting	Gyro2 (AIL) setting	Gyro3 (ELE) setting
Gyro	Model1 Normal		
	Gyro(RUD)	Gyro2(AIL)	Gyro3(ELE)
Rate 1	Normal 80	Normal 50	Normal 50
	ON (80)	ON (50)	ON (50)
Rate 2	Normal 80	Normal 50	Normal 50
	INH (80)	INH (50)	INH (50)
Rate 3	Normal 80	Normal 50	Normal 50
	INH (80)	INH (50)	INH (50)

	Gyro(RUD)	Gyro2(AIL)	Gyro3(ELE)
Rate 1	ON Sngl	INH Sngl	INH Sngl
Rate 2	GY --	GY --	GY --
Rate 3	Normal 80	Normal 80	Normal 80
Fine tuning	-- +0	-- +0	-- +0

Setting method

- When using this function, Tap [INH]. (ON is displayed.)
- When you want to set the same contents at other conditions, select the group mode. When you want to set the selected condition only, select the single mode (initial setting).
- Three rates can be switched for each condition. (Rate 1/Rate 2/Rate 3)
- A fine tuning VR can be set.

Usage example #1: Using gyro for only the rudder and adjusting sensitivity for each condition

* Gyro gain channel

Gyro : CH5

For the FASSTest12CH, Gyro/RUD is 6ch. The gyro sensitivity adjustment connector connects to 6ch.

- Select [Gyro] at the model menu and call the setup screen.

Tapping here will let you select either Normal or AVCS.

This is all that is needed for use in this case.

Set gain of a rudder

	Gyro	Mod				
	Gyro(RUD)	Normal		Gyro2(AIL)		Gyro3(ELE)
Rate 1	Normal	80		Normal	50	Normal
	ON	(80)		ON	(50)	ON
		80		Normal	50	Normal
		(80)		INH	(50)	INH
Rate 3	Normal	80		Normal	50	Normal
	INH	(80)		INH	(50)	INH

Because the sensitivity is switched (Sngl) per condition, Rate 2 and Rate 3 are not used.

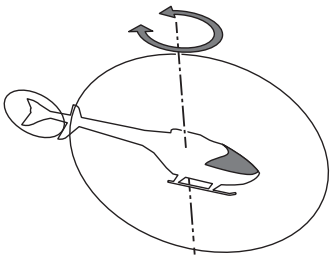

Because sensitivity changes for hovering and idleup, perform switchover for each condition and adjust sensitivity.

Usage example #2: Using 3-axis gyro CGY750 and adjusting sensitivity for each condition

* Gyro gain channel

Gyro RUD : CH5 For the FASSTest12CH, Gyro/RUD is 6ch.

Gyro2 AIL : CH9

Gyro3 ELE : CH10 For the CGY750, simply connect the S.BUS; functions do not need to be set.
(For the FASSTest12CH, change Gyron/RUD to 6ch.)

- Select [Gyro] at the model menu and call the setup screen.

Tapping here will let you select either Normal or AVCS for each of the three axes.

This is all that is needed for use in this case.

Set gain of a rudder

Set gain of an aileron

Set gain of an elevator

	Gyro	Model1				
	Gyro(RUD)	Normal		Gyro2(AIL)		Gyro3(ELE)
Rate 1	Normal	80		Normal	50	Normal
	ON	(80)		ON	(50)	ON
		80		Normal	50	Normal
		(80)		INH	(50)	INH
Rate 3	Normal	80		Normal	50	Normal
	INH	(80)		INH	(50)	INH

Because the sensitivity is switched (Sngl) per condition, Rate 2 and Rate 3 are not used.

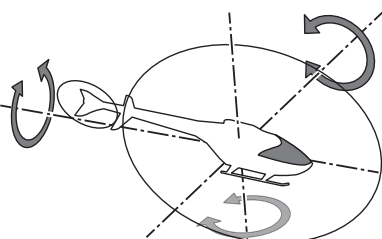

Because sensitivity changes for hovering and idleup, perform switchover for each condition and adjust sensitivity.

Governor

When using a Futaba governor, this function is used to switch the RPM of the helicopter's head. Up to 3 rates can be set for each condition.

*The governor is used by connecting the governor speed setting channel to CH7 (initial setting).

*When using an independent governor [ON]/[OFF] switch, connect the AUX([ON]/[OFF]) connector of the governor to CH8 (initial setting) and set the switch to CH8 (Governor2) at the Function menu of the Linkage menu.

*When using the Fuel Mixture function, the mixture servo is controlled from the governor. When transmitting the mixture curve data from the transmitter to the governor, the governor AUX (m.trm) connector must be connected to CH8 (initial setting) and governor side setting performed. See the governor instruction manual.

Note: Always set (Control) and (Trim) to [--] for [Governor] and [Governor 2] of the Function menu of the Linkage menu.

- Select [Governor] at the model menu and call the setup screen shown below.

- Return to Model menu

The screenshot shows the Governor setup screen with the following details:

- Header: Governor, Model1 Normal, 6.7V
- Three columns for Rate 1, Rate 2, and Rate 3.
- Each rate column has an INH button and a Sngl button.
- Rate 1, 2, and 3 each have a Rate setting of 50.0 (50.0) and a Tuning setting of +0 (+0).
- At the bottom, there is a Unit selection menu with options [%] and [rpm], and a Mode selection menu with options 1000, -, and 2000 rpm.

Annotations on the screenshot:

- An arrow points from the Model menu to the Governor screen.
- A box labeled "RPM adjustment" points to the Rate settings.
- A box labeled "Fine tuning VR settings" points to the Tuning settings.
- A box labeled "Unit display selection: [%] [rpm]" points to the Unit selection menu.

Setting method

•Activate the mixing

When using this function, Tap [INH]. (ON is displayed.)

*When the function is set ON/OFF at the governor setup screen, the governor rpm setting channel end point servo travel and limit point are now initialized.

*When changed from INH to ACT (ON), the servo travel is initialized to 100 and the limit point is initialized to 155.

*When operation is changed to INH at all conditions, the servo travel is initialized to 100 and the limit point is initialized to 135.

•RPM adjustment

Tap to the rate item.

Adjust the rpm using the "▼▼" "▼" "▲" "▲▲" buttons.

Initial value: 50% (1500rpm)

Adjustment range: OFF, 0~110% (OFF, 700~3500rpm)

*When the value is tapped reset to the initial value.

•Unit display selection

Tap to the UNIT item [%] [rpm]. Select the unit.

●Diplay mode selection

- *When [rpm] mode is selected above setting, the display mode can be selected.
- *There is no change in the transmitter output even when the "Mode" is changed. Calibration should be performed via the governor.
- *In order to use the Governor function of the T16IZ SUPER, it is necessary to change the settings on the governor for the low side 700 rpm mode.

When the Mode of the Governor screen's model menu is changed, the change is also indicated on-screen.

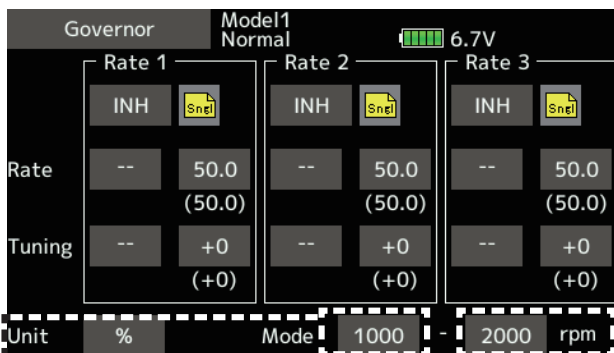

The chart below indicates the mode percentage and the corresponding RPM.

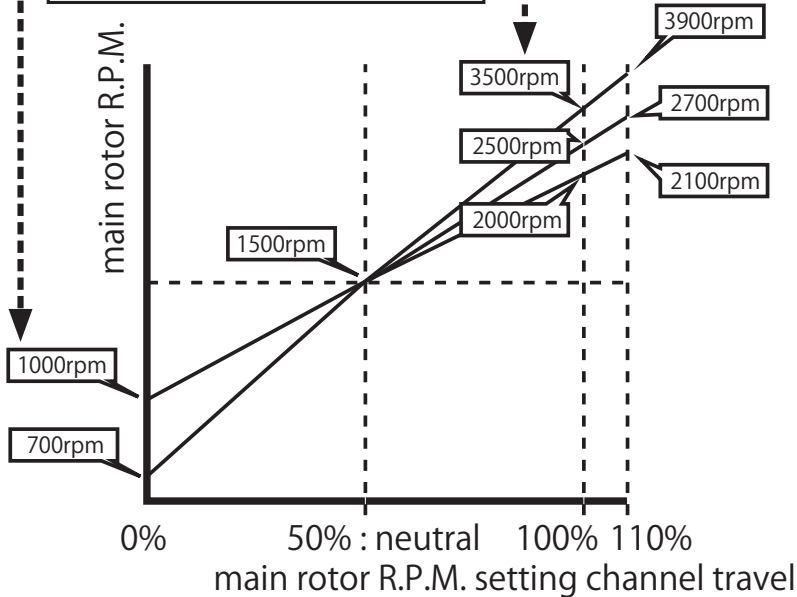

●Fine tuning VR settings

Tap to the [--] item and tap the screen to access the selection screen. Select the control.

*For a description of the switch selection method, see the description at the back of this manual.

Tap to the rate item.

Adjust the trim rate using the "▼▼" "▼" "▲" "▲▲" buttons.

Initial value: 0% (0rpm)

Adjustment range: -20~+20%

*When the screen is tapped for one second, the sensitivity is reset to the initial value.

Tap the screen to return to the cursor mode.

Gyro setting

The T16IZ SUPER has the same functions as the GPB-1.

The CGY755 / CGY760R can be set up from the T16IZ SUPER screen by connecting to the T16IZ SUPER. Some functions can be set wirelessly.

*CGY760R needs to be Ver3.0 ~. Update CGY760R.

A. Wired connection: Advanced settings (all functions same as GPB-1)

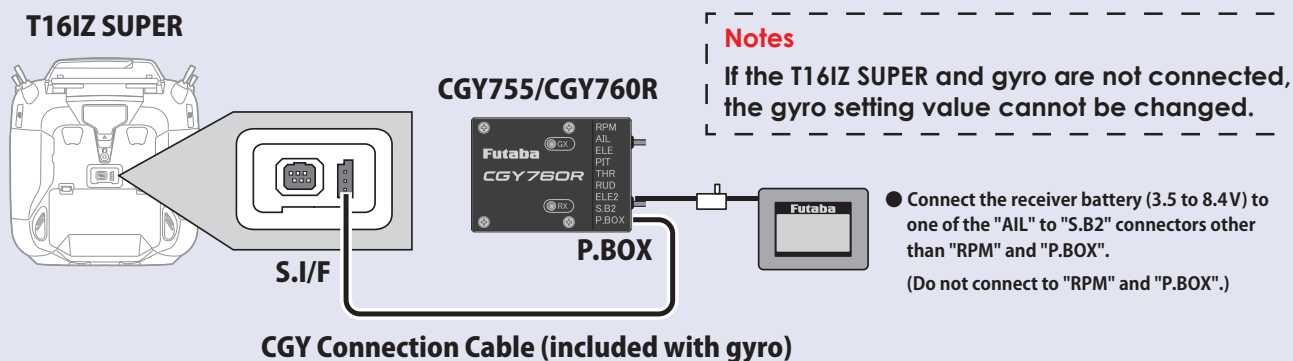

B. Wireless tunings: Gyro tunings can be made wirelessly. (Limited items)

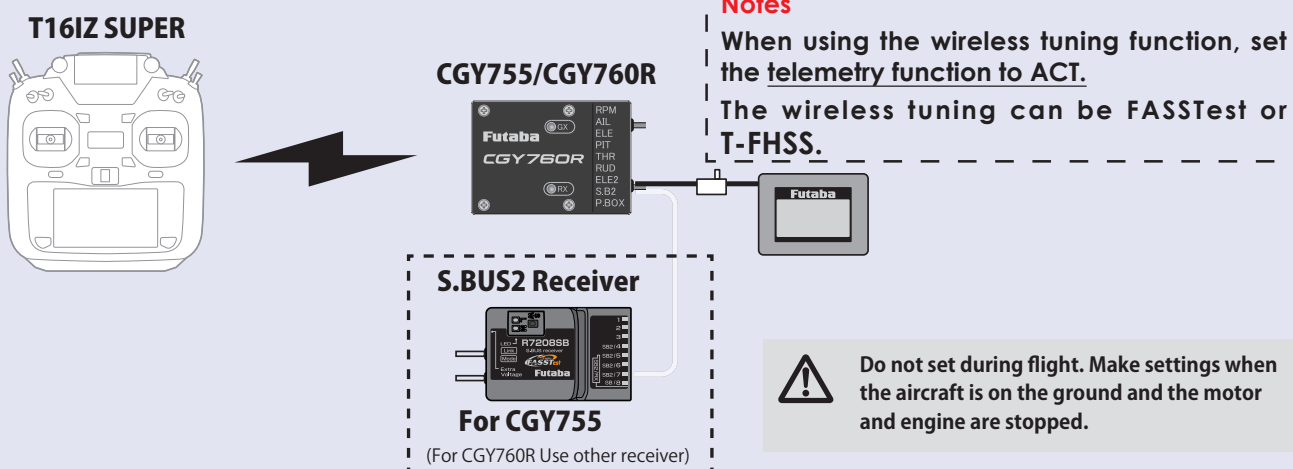

Wireless Tunings function list

-FLT. TUNE

Base Gain: Gyro base gain setting
CYC. Rt: Cyclic rate setting
Cnt. AuthAIL: Control Authority Aileron
Cnt. AuthELE: Control Authority Elevator
EXPO.: Exponential
FLT. Styl: Flight style
ELE. Comp: Elevator pre compensation

-SWH. BASIC

SWS. Rate: Rate adjustment
PIT. Rate: Rate adjustment
SWS. Ring

- Governor Basic

GOV Gain: Governor gain
L Lmt. L rpm : Low limit hovering RPM
L Lmt. H rpm : Low limit idling RPM

-Flight Tune Expert

HeadHld A : Head hold aileron
StopTune A : Stop tune aileron
HeadResp: Head Response
HeadHld E: Head hold elevator
StopTune E : Stop tune elevator

-Rudder Expert

EXP. AVCS: Rudder exponential AVCS
EXP. NORM: Rudder exponential NORMAL
CNT. DIIn: Control delay in
CNT. DIOut: Control delay out
ANG: Pirouette speed
Tail Resp: Tail response

Gyro setting CGY755 CGY760R



A. Wired connection: Advanced settings

1

Model menu	New-1 Normal	7.7V	1/1
Servo monitor	Condition select	AFR	
Dual rate	Program. mixes	Pitch curve	
Throttle curve	Acceleration	Throttle hold	
Swash mixing	Throttle mixing	Pitch → Needle	
Pitch → Rudder	Gyro	Governor	
Gyro Setting			

⚠ CAUTION

❗ Be sure to connect and disconnect the CGY760R/CGY755 and T16IZ SUPER connection cable with the power off.

1. Select "Gyro setting" on the last page of Helicopter Model Menu

*If "CRSF" is ON in the system type of the linkage menu, "Gyro setting" cannot be selected.

2

When "GY Settings Transfer" is selected, the gyro setting data saved in T16IZ SUPER is written to the gyro.

* At this time, if Gyro is not connected to T16IZ SUPER by wire, the EQ ID screen appears.

2. Select "Start"

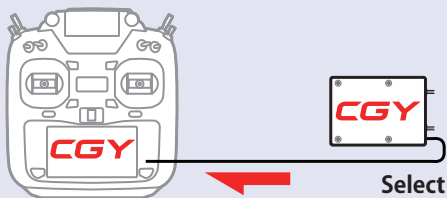

Select "Start" This will download the gyro data to the T16IZ SUPER.

3

→ To basic menu
 → To expert menu
 → To receiver

3. Home screen is displayed

◆ When copying data from Gyro A to Gyro B

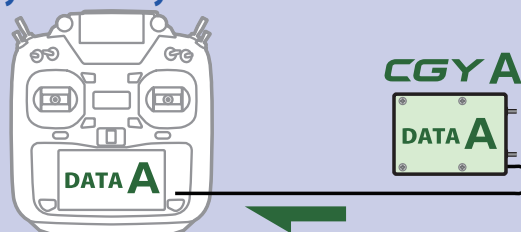
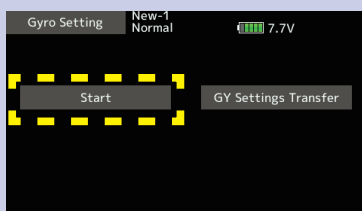

Connect the gyro A to the T16IZ SUPER and press [Start]. (Enter the data of A into T16IZ SUPER)

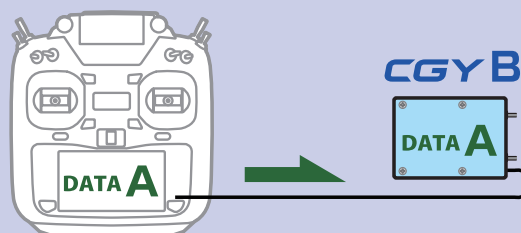

If you press Start here, the B data will be written to the T16IZ SUPER and the A data will be lost.

Connect Gyro B to T16IZ SUPER and press [GY Settings Transfer]. (Put data on A into gyro B)

Gyro setting CGY755 CGY760R



B. Wireless tunings

Before making Wireless tunings, it is necessary to download the setting data from the gyro to the T16IZ SUPER via a wired connection.

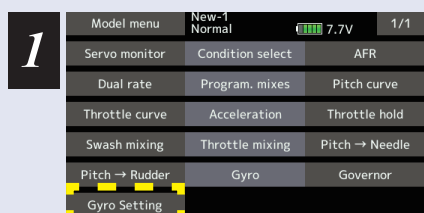
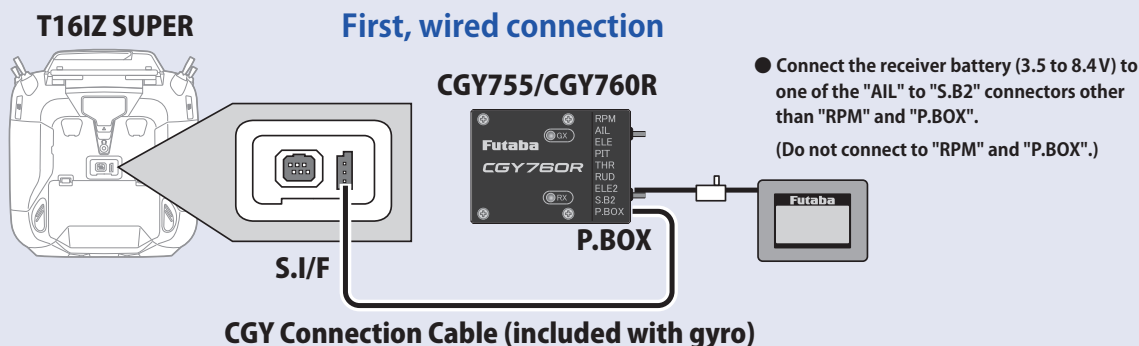

1. Select "Gyro setting" on the last page of Helicopter Model Menu

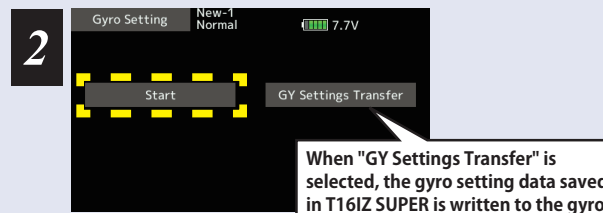

2. Select "Start"
This will download the gyro data to the T16IZ SUPER.

Next, Wireless tunings

Once the gyro data is stored in the T16IZ SUPER, if it is the same gyro, there is no need to make a wired connection from the second time on. If you want to use another gyro, you need to reconnect the cable and download the data.

To configure the Wireless tunings, set two consecutive free channels to use for Wireless tunings in SBUS Basic 4/4.

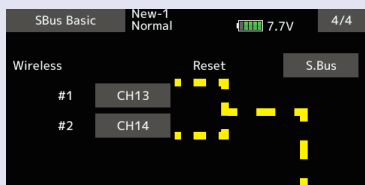

2 consecutive free channels

Linkage menu → Function
Example using 13CH and 14CH

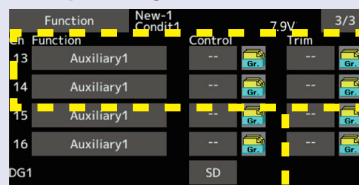

Set Control and Trim to NULL (--).

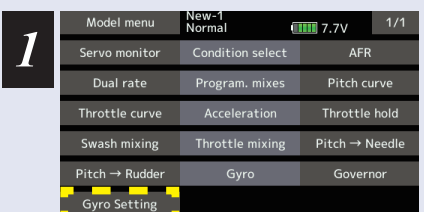

1. Select "Gyro setting" on the last page of Helicopter Model Menu

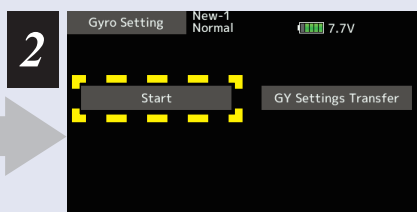

2. Select "Start"

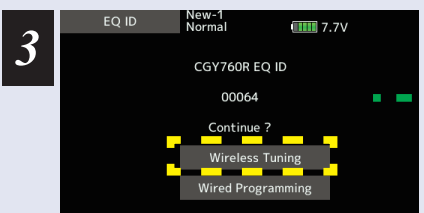

3. Select "Wireless Tuning"

Check that the gyro to be set matches the EQ ID.

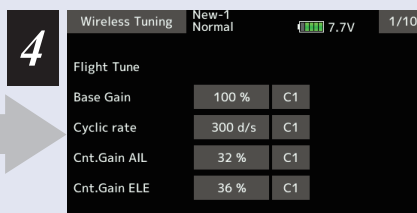

4. Items that can be set wirelessly are displayed

Home Screen

Home Screen Display

On the home screen, basic information such as swash type, gyro operation mode, sensitivity and governor ON / OFF, engine operating time etc, are displayed.

For functions that can set conditions in this manual, mark **Cond** is written.

Condition number

With switch operation from the transmitter, several parameters can be switched by setting up to 5 types of data. If you set the condition switch to the channel having the AFR function of the transmitter and set the point for each flight condition with the AFR point curve, it can also be linked with the flight condition switch.

• When either the DG1 or DG 2 switch is selected, the following options are available.

Function Menu of your transmitter (DG1). Assigning DG1 to a switch or flight mode allows the use of two separate values for the condition selectable parameters.

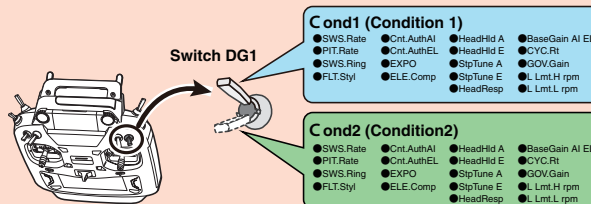

*Indicates when the setup style is "3D".

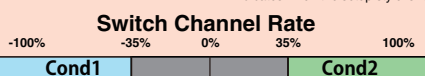

• If you set a condition switch channel, using the AFR function on that channel set a flat point curve for each flight condition. Then you can utilize all 5 flights conditions.

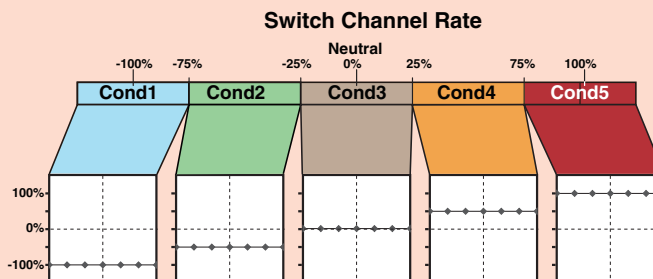

Set the point curve with AFR for each flight condition of the transmitter.

Swash plate type

Displays the swash plate type set in "SWH. BASIC" menu.

Gyro operation mode / Gyro gain

Displays "AVCS" or "Normal" operation mode and gyro gain of aileron (roll), elevator (pitch) and rudder (yaw) axis.

Governor ON / OFF

Indicates the ON / OFF switch status of the governor function. When "ON" is displayed, the governor function is activated.

RPM display

The maximum RPM of the engine or rotor head RPM memorized by the governor during operation is displayed. Data is reset when the power is turned off. If you want to check multiple times during the flight, leave the power on after flight. Press and hold RPM button to reset the display.

Engine running time

Displays the running time of the engine. Up to 9,999 hours are displayed. Press and hold time button to reset the display. The operation time is stored in memory even when the power is turned off until it is reset.

Battery voltage

Displays the voltage of the receiver battery connected to CGY.

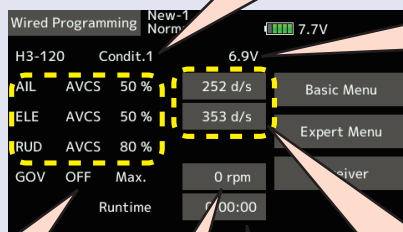

Roll and Elevator rate maximum display

This screen displays the maximum roll rate and maximum elevator rate recorded during flight. Data is reset when the power is turned off. If you want to check the maximum rate, leave the power on after flight. Press and hold rate button to reset the display.

Home Screen

Home Screen

Wired Programming	New-1 Normal	7.7V
H3-120	Condit.1	6.9V
AIL	AVCS 50 %	252 d/s
ELE	AVCS 50 %	353 d/s
RUD	AVCS 80 %	
GOV	OFF Max.	0 rpm
	Runtime	0:00:00

Basic menu screen

Basic Menu	New-1 Normal	7.7V
Flight Tune		
Swash Basic		
Rudder Basic		
Governor Basic		
SBus Basic		

- ◆ Flight Tune (Aileron, Elevator)
- ◆ Swash Basic (Swash)
- ◆ Rud Basic (Rudder)
- ◆ Gov Basic (Governor)
- ◆ S.BUS Basic

Expert menu screen

Expert Menu	New-1 Normal	7.7V
Swash Detail		
Flight Tune Expert		
Rudder Expert		
Governor Expert		

- ◆ Swash Detail (Swash)
- ◆ Flight Tune Expert (Aileron)
- ◆ Rudder Expert (Rudder)
- ◆ Governor Expert (Governor)

Receiver screen

Receiver	New-1 Normal	7.7V
Internal Rx	ACT	
RF type	FASSTest	

- ◆ Internal Rx
- ◆ RF type

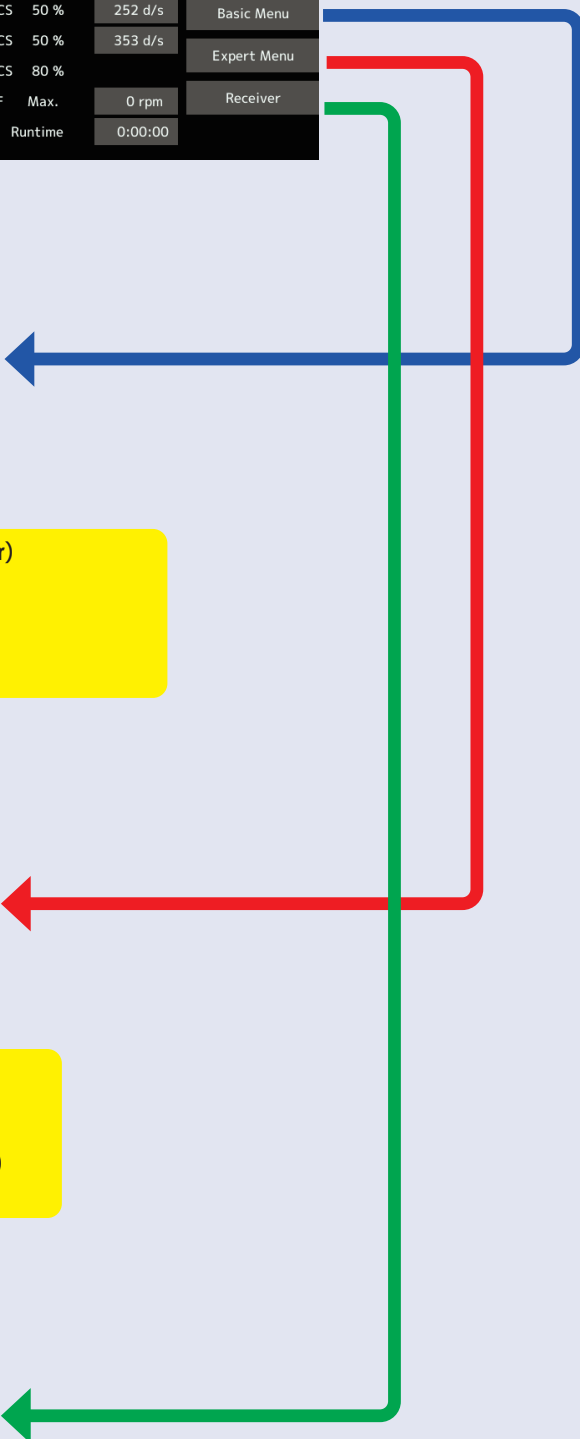

Basic Menu

As the name suggests, this menu allows changes to the basic settings of CGY.
Make sure to set each "BASIC MENU".

Basic menu screen

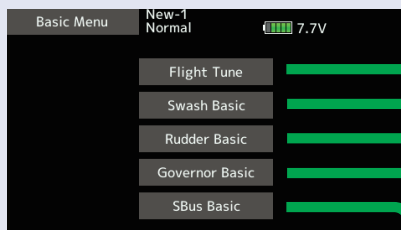

◆ Flight Tune (Aileron, Elevator)

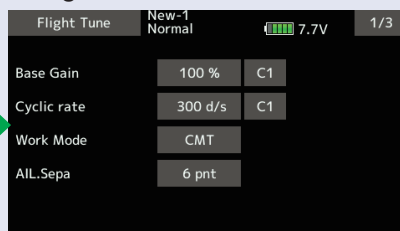

◆ Swash Basic (Swash)

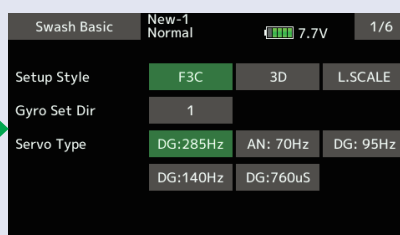

◆ Rud Basic (Rudder)



◆ Gov Basic (Governor)

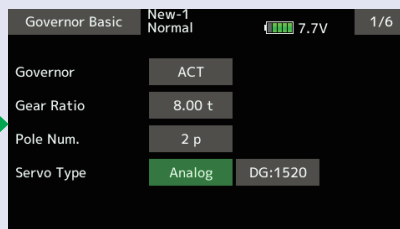

◆ S.BUS Basic



S.BUS Basic Menu

The "SBUS BASIC" screen is accessed via the "BASIC MENU" screen. Set the CH for each function according to the transmitter to be used. Any unused functions should be set to INH (Inhibited). For example, if the Gain A/E and Gain RUD remote gain functions are not going to be used, then set them to [INH]. The CGY760R/CGY755 will then allow you to make gain adjustments within the respective menu.



The channel of each function can be changed.

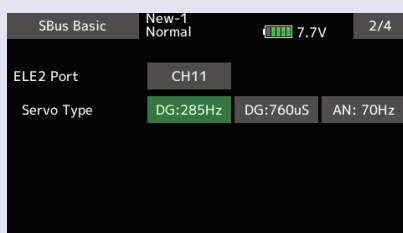

ELE2 channel Servo Type

(If you want to use the ELE2 port for purposes other than swash.)

This selects the ELE2 servo types. There are three types of the servo driving frequency selection, AN:70Hz, DG:285Hz, and 760µS. All Futaba digital servos can be operated with fastest DG:285Hz mode but some of other brands of servos do not support DG:285Hz mode. In this case, select the proper servo driving frequency per the manufacturer's specifications.

If you select H4-00 or H4-45 with 4 servo swashes, cannot set this ELE2 port servo type. In that case, select all swash servo types in SWH basic servo type.

Setting: AN:70Hz/DG:760 µS/DG:285 Hz Initial setting: DG:285 Hz

WARNING

⚠ The servo type parameter within the CGY must match the type of servo you are using. Incorrect setting may damage the CGY or the servo. Incorrect setting may also result in a loss of control during flight.

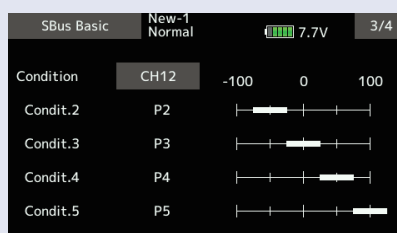
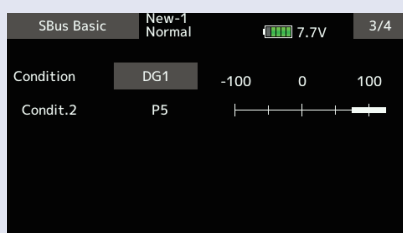

S. BUS connection: Condition on change channel

Using the methodology described previously, determine the "Cond CH #" and set the condition change channel of the transmitter. In this example, DG1 is the conditional change channel.

As with the flight condition function of the transmitter, it is possible to utilize pre-determined settings, each activated by a switch or switches on the transmitter. By setting the condition switch on the channel with the AFR function of the transmitter and setting the point for each flight condition with the AFR point curve, you can switch the condition of CGY760R/CGY755 in conjunction with the flight condition switch of the transmitter.

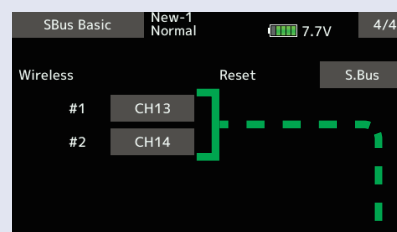
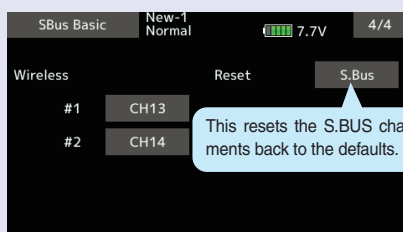

2 consecutive free channels

Wireless channel

The wireless channel uses two consecutive channels. For example, if CH13 is set to "# 1", CH14 is automatically set to "# 2". Therefore, when using this function, two consecutive free channels are required for the transmitter. It is not possible to use a channel assign that is used for another function.

CAUTION

- ⚠ Be sure to check the operation for all conditions 1 to 5 before flying.
- ⚠ The setting of "wireless CH" is possible only when the transmitter and the CGY are powered off and the CGY is turned on.
- ⚠ Be sure to connect and disconnect the CGY and T16IZ SUPER connection cable with the power off.

Swash Basic

This menu is utilized to perform the basic setup of swash motion. "SWH. BASIC" screen from the "BASIC MENU" screen.

The CGY760R/CGY755 is compatible with the following six types swash plate.

⚠ WARNING

⊘ Do not connect the servo to the gyros until you select the servo type in the "SWH. BASIC" menu.

*If the servo type is incorrect, it is possible to damage the servos or CGY.

The green display is the current state.

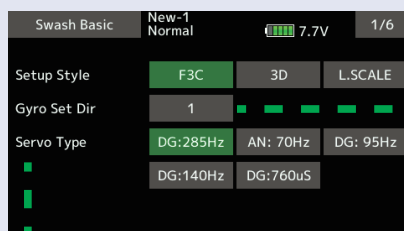

(1) Setup style

3D mode contains a proven set of parameters which are good for not only 3D but also F3C flying. F3C Mode and L.SCALE (Large scale model) Mode are for unique or special tuning types only.

*When the style is changed, setting of AIL/ELE/RUD is re-initialized and defaults are changed.

L.SCALE: Initial parameter mode corresponding to a large machine with a total length of 2.5 m or more.

(2) Gyro Set Dir: Mounting direction

Set the roll axis, pitch axis, yaw axis according to the mounting direction of CGY. When the LED on the Gx side finishes blinking, please turn the power off and on again to confirm that it is working properly.

Setting: 1 ~6 Initial setting: 1

⚠ WARNING

If you do not turn the power back on after changing "Gyro Set Dir", the gyro will not operate properly, there is a risk of crashing.

Gyro Set Dir--- 1

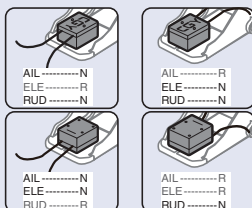
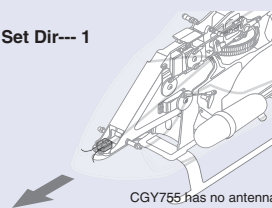

Gyro Set Dir--- 2

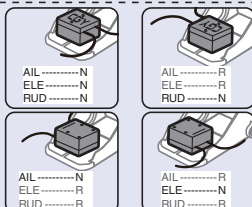
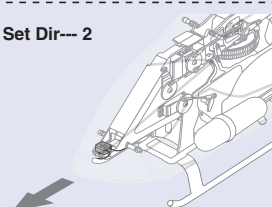

Gyro Set Dir--- 3

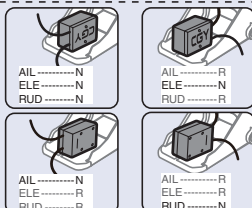
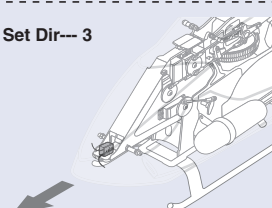

Gyro Set Dir--- 4

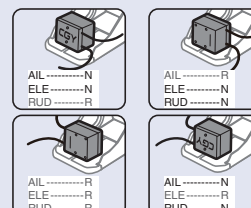
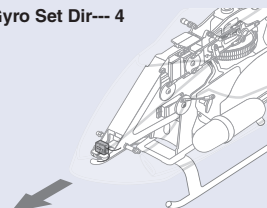

Gyro Set Dir--- 5

*Depending on the type of mounting plate, it is also possible to mount as shown in the figure.

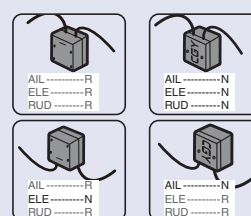
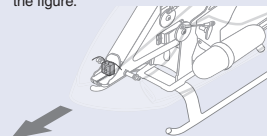

Gyro Set Dir--- 6

*Depending on the type of mounting plate, it is also possible to mount as shown in the figure.

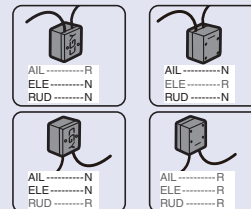
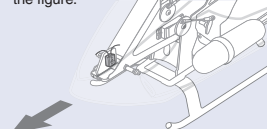

(3) Servo Type

This selects the swash servo types. There are four types or modes of the servo driving frequency selection, AN:70 Hz, DG:95 Hz, DG:140 Hz, DG:285 Hz, and 760 μS. All Futaba digital servos can be operated with fastest DG:285 Hz mode but some of other brands of servos do not support DG:285 Hz mode. In this case, select the proper servo driving frequency per the manufacturer's specifications.

Setting: AN:70 Hz/DG:95 Hz/DG:140 Hz/DG:760 μS/DG:285 Hz
Initial setting: DG:285 Hz

⚠ WARNING

⊘ The servo type parameter within the CGY must match the type of servo you are using. Incorrect setting may damage the CGY or the servo. Incorrect setting may also result in a loss of control during flight.

Swash Basic

Swash Basic	New-1	7.7V	2/6
SWASH Type	H3-120	H3-140	H3-90
	H4-00	H4-45	H1
Servo Dir #	1		

(4) SWASH Type: Swash change to plate type

Select the swash plate type. When you change the setting, other data is initialized.

Setting: H-1/H3-120/H3-140/H3-90/H4-00/H4-45 Initial setting: H3-120

⚠ WARNING

❗ All of the swash plate parameters are reset when the swash plate type is changed. Doing so eliminates any possible errors or malfunctions within the system. After changing the swash plate type, Please proceed through the entire setup process once again before attempting to fly the model.

FRONT

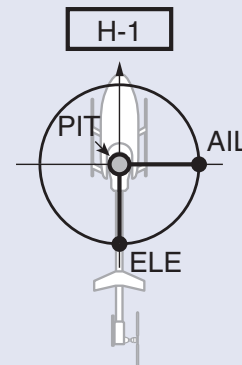
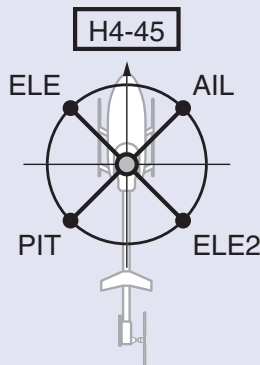
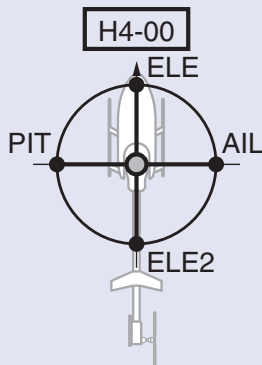
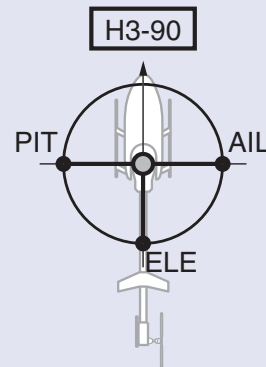
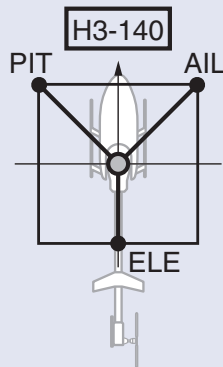
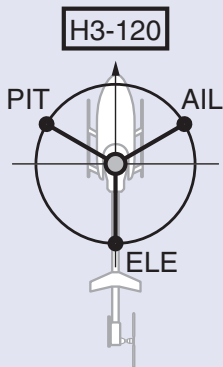

AIL-----Aileron servo
 ELE-----Elevator servo
 PIT-----Collective pitch servo
 ELE2-----Second elevator servo

Your transmitter should be reset to the default settings and the swash plate type selected with the transmitter should be set to "H-1" or single servo mode. All CCPM mixing is set up and handled in the CGY, and the transmitter functions should not be used. Before starting model set-up, be sure that all dual rates, pitch curve, and endpoint values are set to 100/100.

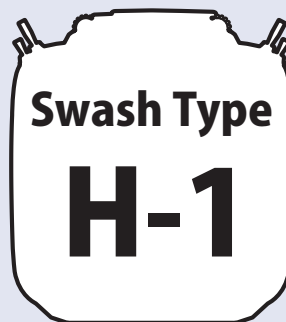

(5) Servo Dir #: Servo direction

Using different servo combinations will create the proper swash plate servo movement in electronic CCPM models (eCCPM). In the H3-xx swash mode, three of the swash servos directions are changed by pressing the Servo Dir #. Choose the combination number which produces level swash plate travel with a collective pitch input from the transmitter. There are 8 combination choices for the H3-xx swash mode. On H4-xx swash mode, there are 16 combination choices. After selecting the combination number, aileron, elevator, pitch, and 2nd elevator servo parameters are automatically set.

Note: Occasionally the aileron or elevator function directions are reversed even though collective pitch direction is correct. In this case, use the "SWS. Dir" parameter on the following screen (4/6) to fix this later.

Swash Basic



(6) AIL, ELE, PIT. Ntr:

Servo neutral adjustment

Adjust the neutral position of the swash servo (aileron, elevator, pitch, second elevator). The second elevator (ELE2) is displayed only when the swash type is H4-xx.

Setting ranges: +240 ~ -240 Initial value: 0

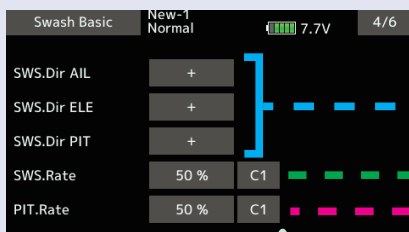

(7) SWS. Dir: Swash direction setting

This selects the aileron, elevator and collective pitch direction. Reverse the direction when the stick movement and swash movement are opposite. Each time you press the +/- button, the polarity switches.

(8) SWS. Rate: Rate adjustment

Cond

The Swash Rate settings are used to set a known base cyclic throw for the gyro to calculate the compensations and gain scale. This value does not represent the total cyclic throw, but rather shows the gyro a known point for the gyro to understand the helicopters geometry. It is important to note that one setting applies to both roll and pitch axes; they are not individually adjusted.

(DUAL RATES MUST BE 100)

-Suggested amount of base cyclic pitch

*800 size – 10 degrees

*700 size – 9 degrees

*600 - 550 size – 8 degrees

*500 size – 7 degrees

*450 and below- 6 degrees

Setting ranges: 0 ~100% Initial value: 50%

*The current condition number of CGY is displayed.
*The setting with "C#" display can be set for each condition.
1. Use the "C#" button to select the condition number.
2. Next, adjust value of the condition selected by the rate button.

For functions that can set conditions in this manual, mark **Cond** is written.

(9) PIT. Rate: Rate adjustment

Cond

The [PIT.Rate] is the amount of collective pitch travel allowed. A good starting range for Sport, 3D and F3C is +/-10 to +/-12 degrees.

Setting ranges: 0 ~100 Initial value: 50%

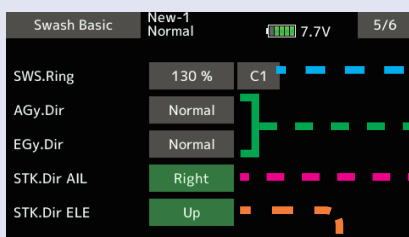

(10) SWS. Ring

Cond

This parameter is used to set the total maximum of cyclic throw as well as limit the swash travel to prevent binding of the swash plate servos when the control stick is moved toward a corner (for example, full right and full aft cyclic).

Setting ranges: 50 ~100% Initial value: 130%

(11) AGy. Dir: Aileron (roll) Gyro direction

EGy. Dir: Elevator (pitch) Gyro direction

This parameter controls which direction the CGY (roll / pitch axis) will compensate when the helicopter rolls (pitches). Pick the helicopter up and roll the helicopter to the right. The CGY should compensate by adding left cyclic to the swash plate. (Pick the helicopter up and rotate the nose of the helicopter downward. The CGY should compensate by adding aft cyclic to the swash plate.)

If the CGY compensates in the wrong direction, then it will be necessary to reverse the compensation direction setting.

⚠ WARNING

❗ Verify that the CGY compensates in the correct direction before flight. If the compensation direction is incorrect the model will roll or pitch uncontrollably even before it leaves the ground.

Be sure to set this aileron motion direction and elevator motion direction so that F/F mixing (Ele Comp and Rud. F/F menu) works effectively. Also, please perform this operation after setting the direction of operation.

(13) STK. Dir ELE: Elevator operation

Load the direction of elevator into the gyro.

[Setting method] Touch the "Up" button to enter the setting mode. "Sure?" Is displayed. Operate the elevator stick fully to the up. If you touch the [Yes] button, the operation direction of elevator is memorized.

⚠ WARNING





❗ Verify that the CGY compensates in the correct direction before flight. If the compensation direction is incorrect the model will roll or pitch uncontrollably even before it leaves the ground.

(12) STK. Dir AIL: Aileron operation

Load the direction of Aileron into the gyro.

[Setting method] Touch the "Right" button to enter the setting mode. "Sure?" Is displayed. Operate the Aileron stick fully to the right. If you touch the [Yes] button, the operation direction of Aileron is memorized.

Swash Basic

Swash Basic	Nsw-1 Normal	 7.7V	6/6
Pit.High	1100		
Pit.Zero	1520		
Pit.Low	1940		

(14) Pit. High: Pitch high memorizing

This parameter saves the full positive collective pitch point into the CGY.
[Setting method] Touch the "Pit. High" rate button to enter the setting mode. Operate the throttle stick fully to the high. Touch the "Pit. High" rate button again. "Sure?" Is displayed. If you touch the [Yes] button. The full positive pitch signal will be saved to the CGY.

(15) Pit. Zero: Pitch zero memorizing

This parameter saves the zero collective pitch point into the CGY.
[Setting method] Touch the "Pit. Zero" rate button to enter the setting mode. Operate the throttle stick to 0 degree pitch. Touch the "Pit. Zero" rate button again. "Sure?" Is displayed. If you touch the [Yes] button. The zero pitch signal will be saved to the CGY.

(16) Pit. Low: Pitch low memorizing

This parameter saves the full negative collective pitch point into the CGY.
[Setting method] Touch the "Pit. Low" rate button to enter the setting mode. Operate the throttle stick fully to the low. Touch the "Pit. Low" rate button again. "Sure?" Is displayed. If you touch the [Yes] button. The full negative pitch signal will be saved to the CGY.

Flight Tune (Aileron / Elevator Basic settings)

Flight tune sets control of helicopter roll (aileron) and pitch (elevator) axis. "FLT. TUNE" screen from the "BASIC MENU" screen.

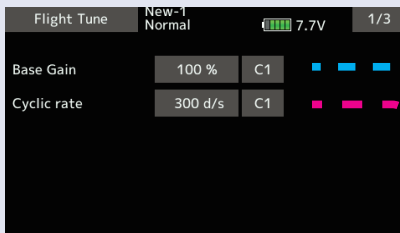

(1) Base. Gain: Gyro base gain setting

Cond

This sets the Cyclic Gyro Base Gain. If the Rotor Head Gain (Rot HD Gn) Channels are set to "INH" within the CGY "SBUS.BASIC" menu, then the remote transmitter gain adjustment is not available. Thus the actual working gain for the cyclic gyros is set by using the "Base Gain" button within this parameter.

Set to 100, a transmitter Gain value of 100% will display 100% on this parameter. If a pilot is in need of more gain, base gain can be increased to allow the gain on the CGY to be higher than 100%.

Note: If using a 6 CH or less "Base Gain" is equivalent to the rotor head gain and can be adjusted manually on the gyro instead of via the transmitter.

Setting ranges: 0~150% Initial value: 100%

(2) CYC. Rt: Cyclic rate setting

Cond

Cyclic rate sets the maximum roll and flip rate (d/s) as limited by the model's ability to reach that set rate. Flip and roll rates are set together with this single parameter.

Setting ranges: 10~500 d/s Initial value: 300 d/s

Flight Tune (Aileron / Elevator Basic settings)

Flight Tune	New-1 Normal	7.7V	2/3
Cnt.Auth.AIL	40 %	C1	
Cnt.Auth.ELE	40 %	C1	
Exponential	-20 %	C1	
FLT.Style	+50 %	C1	

(3) Cnt. AuthAIL: Control Authority Aileron Cond

Aileron Control Authority changes the rate at which the gyro will try to achieve the set "CYC. Rt". A higher value will create a quicker accelerated reaction to a stick input to reach and stabilize to the "CYC. Rt" value; a lower value will reach the desired "CYC. Rt" slower and accelerate slower to the desired angular rate.

Note: Setting this value too high could lead to a jerky feeling when making rapid stick corrections, a value too low will give you the impression the model is not following the pilot's stick inputs. Values of between 20-60 are the suggested range for most helicopters.

Setting ranges: 0~100%
Initial value: Cnt. AuthAIL = 40%

(4) Cnt. AuthELE: Control Authority Elevator Cond

Elevator Control Authority changes the rate at which the gyro will try to achieve the set "CYC. Rt". A higher value will create a quicker accelerated reaction to a stick input to reach and stabilize at the "CYC. Rt" value; a lower value will reach the desired "CYC. Rt" slower and accelerate slower to the desired angular rate.

Note: Setting this value too high could lead to a jerky feeling when making rapid stick corrections, a value too low will give you the impression the model is not following the pilot's stick inputs. Values of between 20-60 are the suggested range for most helicopters.

Setting ranges: 0~100%
Initial value: Cnt. AuthELE = 40%

(5) EXPO.: Exponential Cond

Tune the exponential as desired to change the feel of the cyclic controls around center stick. Negative values soften control feel; Positive values increase sensitivity.

Note: that any exponential present in the TRANSMITTER adds to the value set in the CGY.

Setting ranges: -100~0~+100% **Initial value:** -20%

(6) FLT. Styl: Flight style Cond

Increasing this value will create a more robotic reaction to the stick, leaving the pilot with the impression that the model is locked into in a position after an input. It will also tend to have a more calculated feeling when making inputs.

-Lowering the value will make the model feel more fluid and easy to rotate with the stick input. The model will feel a little more lively during faster cyclic movements and direction changes.

Setting ranges: 0~+100n **Initial value:** +50n

Flight Tune (Aileron / Elevator Basic settings)

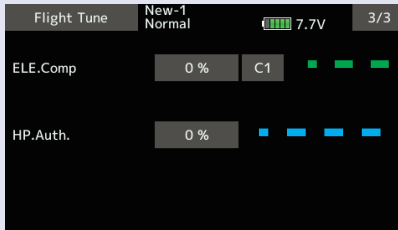

Note: To effectively operate the next "ELE Comp" (elevator correction), make sure to set "Pit High", "Pit Zero", "Pit Low" on the "SWASH BASIC" menu.

(7) *ELE. Comp: Elevator pre compensation* Cond

A helicopter that has a head that rotates clockwise, will exhibit a tendency whereby the nose will be pulled towards the disk with positive blade pitch. Conversely, the helicopter will push the nose away from the rotor disk during negative pitch inputs. In an instance of a slower servo set-up or larger (heavier) rotor blades, a small amount of elevator pre compensation may be needed to keep the nose of the helicopter flat at all times during collective pitch changes. In most cases with helicopter high-speed servos and standard 3D rotor blades, this function is not needed. If you do notice a slight tendency for the nose to try to rise or fall with collective input, increasing "ELE Comp" will reduce this behavior.

Setting ranges: 0~100% **Initial value:** 0%

(8) *HP. Auth.: High pitch authority*

When a rotor blades angle of attack is increased, the rotor blade becomes less reactive, in turn the helicopter might not feel as reactive at high pitch angles. If you want to increase the reaction of the cyclic during loaded and high pitch maneuvers, "HP. Auth" will increase control authority and can be used to make the helicopter feel more linear under loading. Some helicopters with direct link CCPM may use this to increase stability at high collective pitch flying as well. If a helicopter feels good for normal flying, but not the same during loaded situations, "HP. Auth" can be used to make it feel more linear. If "HP. Auth" is set very high, the helicopter will feel more aggressive at high pitch than around neutral.

Setting ranges: 0~100% **Initial value:** HP. Auth = 0%

Rudder Basic

In the "Rudder Basic" menu, you make the basic setting of the rudder gyro.

"Rudder Basic" screen from the "BASIC MENU" screen.

⚠ WARNING

❗ The servo type parameter within the CGY must match the type of servo you are using. Incorrect settings may damage the CGY or the servo. An incorrect setting may also result in a loss of control during flight.

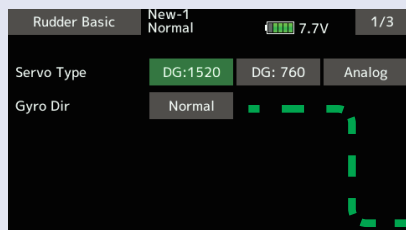

(1) Servo Type

Select the appropriate setting for the tail rotor servo.

Setting: Analog/DG:1520/DG760
Initial setting: DG:1520
DG 1520: BLS254, BLS257, S9254, S9257
DG 760: BLS276SV, BLS2515B, BLS251, S9256, S9251

(2) Gyro. Dir: Gyro direction

This parameter controls which direction the CGY (yaw axis) will compensate when the helicopter rotates. Hold the tail rotor linkage over the linkage ball on the servo, pick the helicopter up by the main shaft and rotate the mechanics counter-clockwise. The CGY should compensate by adding clockwise rotation pitch to the tail rotor blades. If the CGY compensates by adding counter-clockwise rotation pitch to the tail rotor blades, then it will be necessary to reverse the Compensation Direction setting by pressing the "Gyro Dir".

Setting value: Normal/Reverse **Initial value:** Normal

⚠ WARNING

⊘ Do not connect the tail rotor servo to the gyro until the servo type has been selected. Operating the servo using the incorrect setting may damage the CGY or the servo.

⊘ Do not operate with the linkage connected until the "Srv. Limit" function correctly sets the servo limit point. If the servo operates beyond the linkage operating range, there is a danger of either the servo or helicopter being damaged.

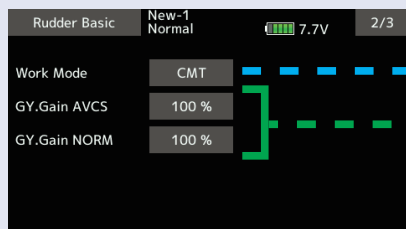

(3) Work Mode: Gyro working mode

The available choices are CMT, Normal or AVCS. The CMT mode will allow you to select either AVCS or Normal mode via the transmitter. In Normal mode the gyro will always operate in Normal Rate Mode, and when AVCS is selected, it will always operate in AVCS Mode.

Setting: CMT/Normal/AVCS **Initial setting:** CMT

(4) GY. Gain: Gyro base gain setting

This parameter sets the base gain of the gyro. This can be used to adjust the gain % if your actual transmitter gain does not match the gain on the CGY correctly.

Setting ranges: 0 ~ 150% **Initial value:** 100%

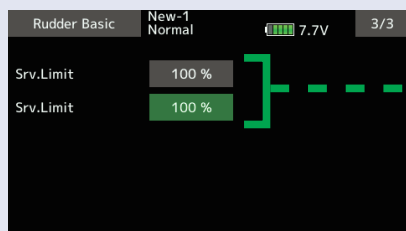

(5) Srv. Limit: Limit setting

When the CGY is in the "Srv.Limit" parameter mode, the gyro will no longer operate and the tail servo will always center when the tail rotor stick is released. Always exit the setup functions before attempting to fly the model. Before each flight, always ensure that the gyros are operating and compensating in the correct direction. The Servo Limit parameter within the CGY is used to set the mechanical limits for the tail rotor servo. To obtain the best performance it is recommended to set the limit in the CGY to 100% for both directions and then adjust the servo arm length to set the mechanical endpoints. After that has been completed, use the servo limit parameter to make small adjustments that could not be made mechanically. Values between 90% and 110% are considered optimal.

[Setting method]

Operate the rudder stick right or left in the direction you want to set. Touch the button that is lit in green to set the limit. Do the same for the other side.

⚠ WARNING

❗ When using the CGY for the first time, or when making mechanical changes involving throw, you must check and set the servo limits again to prevent binding.

Governor Basic

This menu sets the governor's fundamental functions. The menu Servo limit point setting must be set first.

"Governor Basic" screen from the "BASIC MENU" screen.

Note: When using the governor function, be sure to make each setting of "Governor Basic".

Note: After completing the linkage of the throttle, be sure to set the "Servo limit point setting" first, and then set the other functions.

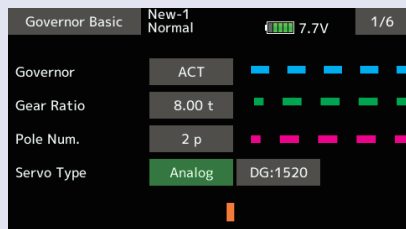

(1) Governor: Governor active

Set the governor operation mode of CGY. The initial setting is "ACT (active)" where, as the designation implies, the governor is active. If you do not want to use governor, select "INH (Inhibit)".

Setting: ACT (Active) / INH (Inhibit) **Initial setting:** ACT

(2) Gear Ratio:

Input the main rotor gear ratio by pushing the "Gear Ratio" button to select the desired working mode.

Setting ranges: 1.00 ~ 50.00t **Initial value:** 8.00 t

Notes:

- If the gear ratio is not properly set, the set speed and actual engine speed will be different.
- The gear ratio should be given in the helicopter instruction manual. If the helicopter instruction manual does not give the gear ratio, calculate the gear ratio as follows:

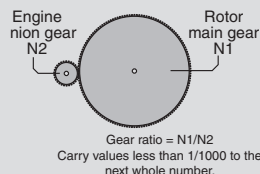

(3) Pole Num.: Pole number

This parameter is used when using a direct phase sensor attachment to a brushless motor lead. Input the motor pole count as specified by the brushless motor manufacturer. When using any revolution sensor other than a direct phase sensor type, set the pole number to 2p.

Note: For nitro use, set to 2p.

Note: The input signal range of the CGY is 0.0v - 3.0v. Exceeding this voltage range may cause damage to the CGY.

Setting ranges: 2-24P **Initial value:** 2P

(4) Servo Type

Select the throttle servo type. Digital servos offer the best response.

Setting: Analog/DG:1520 **Initial setting:** Analog

⚠ WARNING

❗ The servo type parameter within the CGY must match the type of servo you are using. Incorrect settings may damage the CGY or the servo. An incorrect setting may also result in the loss of control during flight.

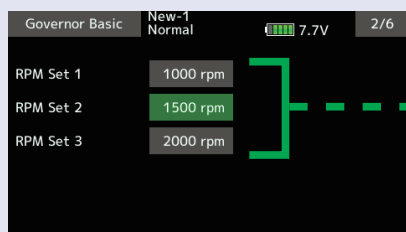

(5) RPM set.: RPM setting

Setting the main rotor RPM. This is calculated by engine revolution with the gear ratio of the main shaft.

When the rotation speed can be set with the governor mixing function of the transmitter, it is necessary to first match the display rpm value of 1-2-3 of "RPM Set" with the display rpm value of the transmitter.

Setting ranges: off / 700 ~ 4,000 rpm **Initial value:** 1,000 rpm

*To set lower than 1,000 rpm, set "Low. Revo" of "Governor Expert" menu to 700 rpm.

Governor Basic

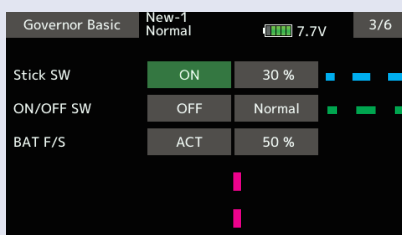

(8) BAT F/S: Battery fail safe

When the receiver battery voltage becomes equal to or less than "BFS. Volt" set in the "Governor Expert" menu, the battery fail safe function is activated, the governor function is turned OFF, and the throttle servo moves to the set position.

When Battery Fail Safe is enabled, items for setting the throttle servo position are displayed. The setting method is the same as "Stick sw", so please refer to this section of the manual for information on setting this function.

If the battery voltage is lower than the set voltage of the "Battery F/S" for about 3 seconds, the Gx (gyro) LED of the CGY solid red light. When "Battery F/S" is set to "ACT" in "GOV BASIC", the servo is fixed to the throttle position set by "Battery F/S". When the throttle stick is set to the slowest position, the "Battery F/S" function is temporarily canceled. However, after 30 seconds, the "Battery F/S" function is activated again and the servo is locked. When the "Battery F/S" operates, quickly landing and stopping the helicopter, please charge the battery.

⚠ WARNING

❗ When using the CGY for the first time, or when making changes in the throw of a servo and its linkage, always perform the limit setting operation.

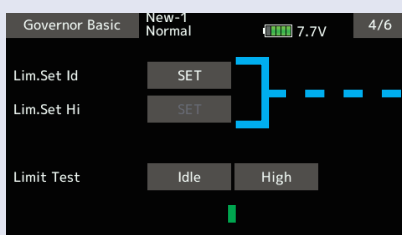

(10) Limit Test: Check the set limit point

Check the set limit point. Press "Idle" or "High" to move the servo to each limit point. Press "End" to end the test.

(6) Stick sw.: Stick switch

The governor can be activated by throttle stick position.

[Setting method] Touch the "Stick SW" button to enter the setting mode. Operate the throttle stick to the position where you want to turn Governor ON. Touch the "Stick SW" button again. "Sure?" is displayed. If you touch the [Yes] button, the ON position is memorized. This stick switch function is always enabled when the next "ON/OFF sw" is "INH" or the "Governor ON/OFF switch" is not set by S.BUS setting.

When governor is turned on and off by transmitter throttle stick

The data is set so that the governor can be turned on and off with the transmitter throttle stick position. The following describes this operation.

- Throttle stick over set point and more than 60% of set rotation speed. → → → ON

- This is the setting value of "Gov. On. Revo: Governor ON revolution setting".

- Throttle stick held at the set point or more Remains. → → → ON

- Throttle stick position is below the set point selected. → → → OFF

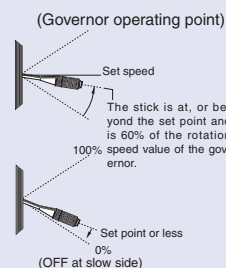

When idle up

- When the throttle curve is set at idle up, and when the throttle output is over the set value (initial value: 30%), the governor will always and remain ON even if the stick is lowered to the bottom.

(7) ON/OFF sw.: Governor on/off switch

This parameter allows the user to turn the governor on or off via a switch on the transmitter. Choose INH if you do not want to use it.

When turning on/off governor with switch

Select the ON / OFF switch channel with "GOV sw channel" on "SBUS BASIC" menu.

Setting the switch to the ON position turns on, or enables the governor. The following describes this operation.

- Switch set to on position and engine running at 60% or more of set speed → → → ON

- Throttle stick set to maximum slow position → → → ON

- Switch set to off position → → → OFF

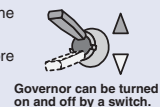

When you activate the switch, the direction setting of the switch is displayed. Select the switch ON/OFF direction (Normal/Reverse).

⚠ WARNING

❗ When using the CGY for the first time, or when making changes in the throw of a servo and its linkage, always perform the limit setting operation.

(9) Lim. set: Servo limit point setting

Servo limit point setting defines the overall travel range for the throttle servo. It is fundamental for governor operation and must be set prior to other functions. Servo limits must also be reset when the throttle linkage or trim are changed.

How to set the servo limit point:

Touch the "Lim.Set Id" button to enter the setting mode. Set the transmitter's throttle stick to the idle position. Touch the "Lim.Set Id" button again. The limit of idle will be saved to the CGY. The cursor will move to "Lim. Set Hi". Set the stick to the full high position. Touch the "Lim.Set Hi" button again. The limit of high will be saved to the CGY. If the setting data is not normal (servo operation amount is 50% or less), "Err" is displayed. In this case, check the transmitter setting and repeat this procedure once again.

Governor Basic



(11) SenseTyp: Sensor type

Select the type of governor sensor.
 Nitro (BPS-1 backplate; Magnet Type)
 1:1 Magnet "1:1 Magn" (Magnet type applied to helicopter part that turns at the same RPM as the main rotor)
 HPoleEP: For Electric motors 8 poles and above
 LPoleEP: For electric motors 6 poles.

(12) GOV Gain: Governor gain

Governor Gain. If the value of the Governor Gain is set too low, the helicopter's RPM will fluctuate with collective and cyclic pitch changes. Conversely, if the number is too high, the RPM itself will fluctuate and surge during flight.

Setting ranges: 1 ~ 100%
Initial value: Nitro = 40%, 1:1Magn = 60%, HPoleEP = 30%, LPoleEP = 10%

(13) L Lmt. L rpm / H rpm: Low limit RPM

Low RPM Limit sets the minimum amount of throttle that the governor will command during an over-speed situation. Too low of value the engine could shut off or not recover power quickly enough during the next collective movement. If the value is set too high, the governor will not control overspeed when the rotor head is unloaded.

Use:
 L Lmt. L rpm: For RPMS of 700-1700
 L Lmt. H rpm: For RPMS of 1701-4000

Setting ranges: L Lmt. Lrpm = 0 ~ 80%, L Lmt. Hrpm = 10 ~ 80%
Initial value: L Lmt. Lrpm = 25%, L Lmt. Hrpm = 45%



(14) SBUS2 rpm out: RPM display on transmitter

When displaying the rpm with the telemetry function, set it to ACT.

Setting: ACT (Active) / INH (Inhibit) **Initial setting:** INH

(15) SBUS2 rpm Slot: RPM display on transmitter

Set the slot number of the telemetry rotation sensor registered on the transmitter side.

This must be set so that no slots overlap one another.

(16) Rev. Sensor: Revolution sensor testing

This menu is utilized to ensure that the revolution sensor is functioning properly. In order to test the sensor, do NOT start the engine. Instead, we recommend turning the engine over by hand or the utilization of a starter. To prevent inadvertent ignition of the engine, do NOT use a glow plug igniter when turning the engine over. The numerical values on the left side of the display are the current value. The right side of the display indicates the maximum sensor value. The output level needs to be more than 60% for correct governor operation. Also, when using the backplate sensor, the signal level of the backplate sensor varies depending on the rotation speed (3,000 rpm or more is the detectable rotation speed).

By the telemetry function, the number of revolutions read by the governor sensor can be displayed on the monitor of the transmitter. In order to be able to display, activate the telemetry rotation sensor (SBS-01RM) on the transmitter and set the gear ratio to 1.00.

Note: It can not be used when the transmitter is FASSTest 12CH system.

Expert Menu

This menu enables the user to further refine the gyro and governor settings.

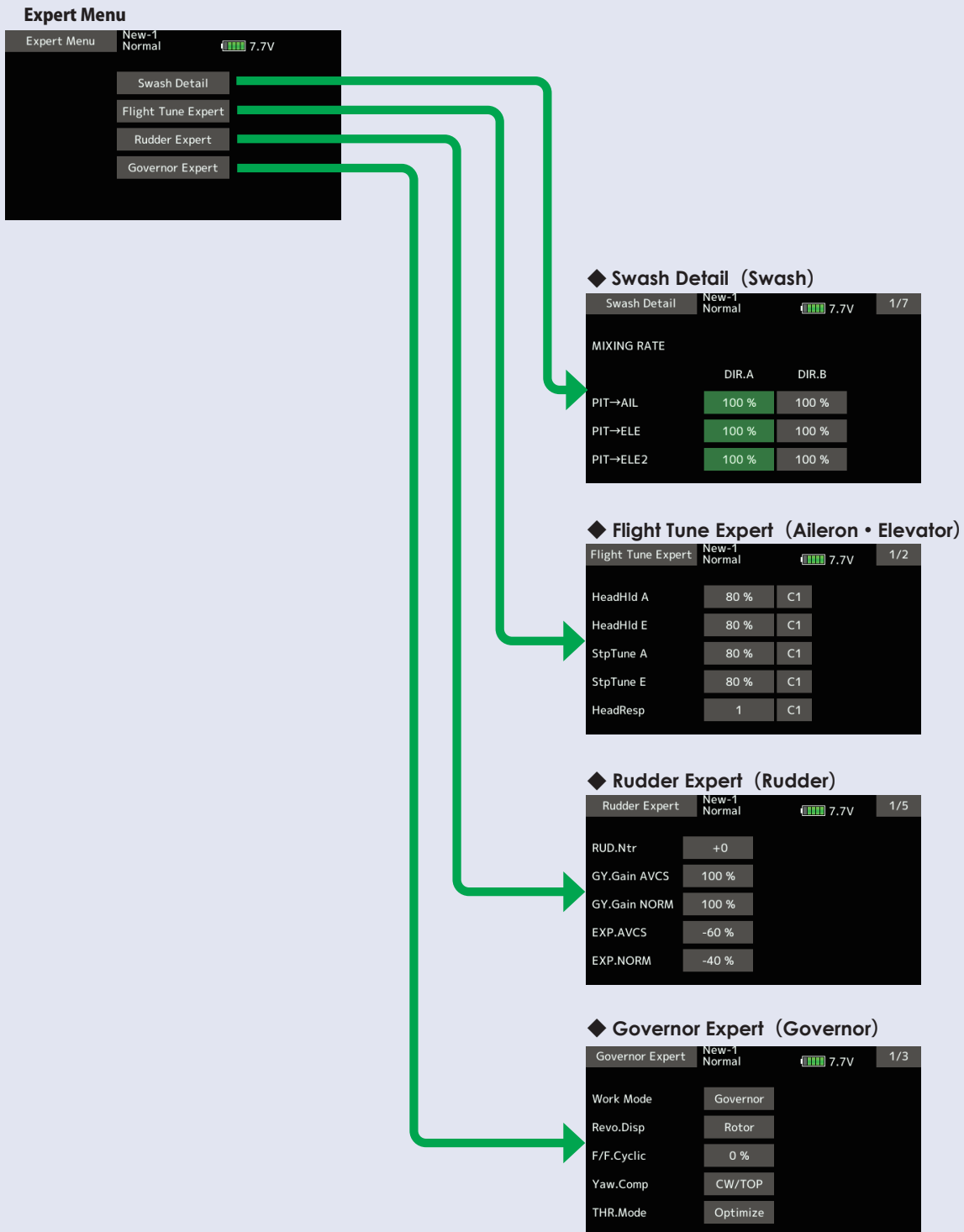

Rudder Expert

The rudder Expert menu allows for further refinement of the tail rotor gyro performance. "Rudder Expert" screen from the "EXPERT MENU 3D" screen.

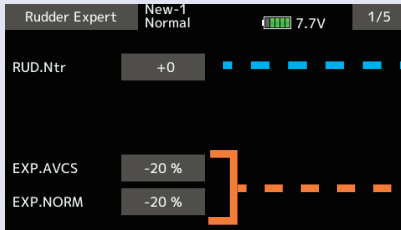

(1) RUD Ntr: Rudder servo neutral setting

This parameter is used to set the neutral position of the rudder servo. Position the rudder servo arm as perpendicular as possible to the tail rotor pushrod prior to making adjustments with this parameter.

Setting ranges: -240~0~+240 **Initial value:** +0

(2) EXP. AVCS / EXP. NORM: Rudder exponential

This parameter sets the feel of the tail rotor control around center. When set to [0] the control curve is linear. Using a [+] value the tail rotor will be more sensitive around neutral conversely, using a [-] value will soften the feeling around neutral. The RUD EXP parameter in your transmitter can also be used to tune the tail rotor to a desired feeling.

Setting ranges: -100~0~+100% **Initial value:** AVCS = -20%, NORM = -20%
Sports = AVCS -60% / NORMAL -40%, 3D = AVCS -20% / NORMAL -20%>

Rudder Expert

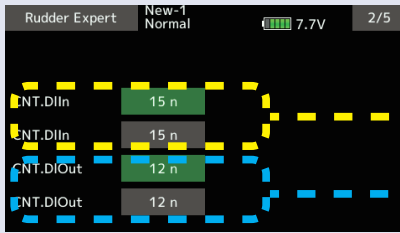

(3) CNT. DIIn: Control delay in

This parameter sets the delay as you move the stick from neutral toward left or right. Larger values result in a softer tail rotor feel off center. This parameter must be adjusted individually for LEFT and RIGHT tail rotor commands. Follow these same procedures to adjust the tail rotor feel in the opposite direction.

[Setting method]

Move the transmitter Rudder stick right or left in the direction you want to set. Touch the green button to enter the setting mode and set the delay amount. Do the same for the other side.

Setting ranges: 0 ~ 20n Initial value: 15n

(4) CNT. DIOut: Control delay out

This parameter sets the delay when the stick is returned back to the neutral position. This parameter is useful to tune how aggressively the tail rotor stops following a pirouette. The higher the value, the softer the stop. This parameter must be adjusted individually for LEFT and RIGHT tail rotor commands. The setting method is the same as "CNT. DIIn", so please refer to the information above.

Setting ranges: 0 ~ 20n Initial value: 12n

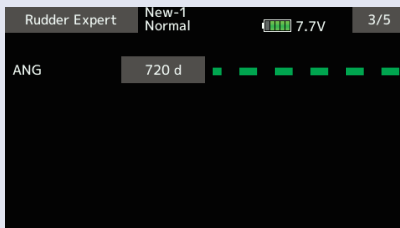

(5) ANG: Pirouette speed

This parameter adjusts the maximum pirouette speed of the tail rotor that the gyro will allow at 100% dual rate.

Setting ranges: 100~999d Initial value: = 720d,

Rudder Expert

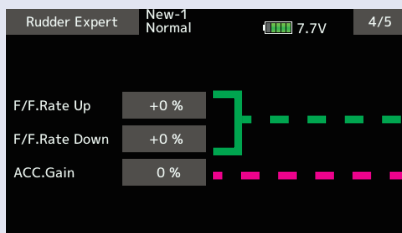

(6) F/F.Rate U / F/F.Rate D: F/F mixing rate

Feed Forward mix is used to counteract sudden increases in torque from the motor during fast collective pitch changes. If you notice a tail kick, using (right rudder on Clockwise rotor disk, left rudder on CCW) F/F mixing can be tuned to reduce the tail kick. The mixing amount can be individually set for high pitch side (U) and low pitch (D) side with zero pitch as the center.

Setting ranges: -100~0~+100% **Initial value:** +0%

(7) ACC Gain: F/F mixing acceleration gain

In low head speed situations where a lot of F/F Mixing might be needed, acc. gain boosts the input and removes it immediately after to help cure the sudden change in torque, but it does not allow the large tail rotor input to alter the axial behavior of the helicopter.

Setting ranges: 0~200% **Initial value:** 0%

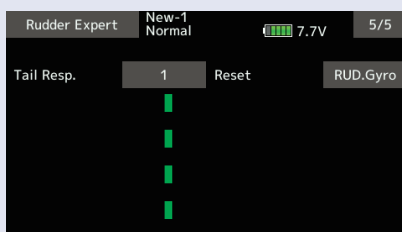

(8) Tail Resp: Tail response

The goal is to match the response between the helicopter tail response and the gyro control. This feature is utilized to do so. 1 is the fastest response. Generally, if the tail response is slow or the servo's speed is slow, setting the tail response setting late will increase the gyro sensitivity and improve the control performance. Also, if the response setting is delayed, the power consumption of the servo will be reduced. However, if the response setting is too late, the operation cannot keep up with high-speed operation of the helicopter.

Setting ranges: 1~5 **Initial value:** 1

(9) RESET : Rudder gyro data reset

This resets the "Rudder Expert" setting back to the defaults.

Flight Tune Expert (Aileron/Elevator Gyro Expert Setting)

The "Flight Tune Expert" menus allow further refinement of cyclic gyro performance. "Flight Tune Expert" screen from the "EXPERT MENU 3D" screen.



(1) HeadHld A / HeadHld E: Head hold aileron / elevator Cond

This feature is used to adjust the heading hold aspect of the gyro control. If the helicopter is not holding angle or cyclic control rates, increasing the heading hold gain will improve holding the helicopter at a certain angle and improve the cyclic rate consistency. If this is set too high you could see an oscillation on that axis. Lowering the heading hold below default would be used if the transmitter gain is reduced and a consistent oscillation is still not fixed during flight.

Setting ranges: 0~200% Initial value: 80%

(2) StopTune A : Stop tune aileron Cond

Cyclic stop tuning on the aileron axis. If the helicopter continues to coast after an aileron roll, lowering "StopTune A" will create a harder stop action to remove the coasting. If the helicopter bounces on the aileron axis after an aileron control input, increasing "StopTune A" will reduce this bounce.

Setting ranges: 0~250% Initial value: 80%

(3) StopTune E: Stop tune elevator Cond

Cyclic stop tuning on the elevator axis. If the helicopter, after an elevator flip, continues to coast, lowering "StopTune E" will create a harder stop action to remove the coasting. If the helicopter continues to coast after an elevator flip, lowering the "Stop tune E" will reduce this bounce.

Setting ranges: 0~250% Initial value: 80%

(4) HeadResp: Head Response Cond

Head Response matches the gyro control speed to that which the helicopter is capable of reacting. In a standard helicopter a Head Response of 1 should always be used, but on some scale applications, or uniquely designed rotor heads, increasing head response might be needed to cure over correction of the gyro.

Setting ranges: 1~10 Initial value: 1



(5) DeadBand: Dead band

Transmitter control dead band. If you are noticing inconsistent swash plate drift or poor initialization it could be poor transmitter potentiometer resolution. If you have to increase this value beyond 10.0, it is best to check calibration on your transmitter.

Setting ranges: 0~25 Initial value: 4.0

(6) RESET : FLT tune data reset

This resets the "FLT.Tun" setting back to the defaults.

Swash Detail

The swash detail setting is used to keep the swash plate level at high and low collective pitch to cyclic interactions and cyclic pitch to collective pitch interactions. "Swash Detail" screen from the "EXPERT MENU 3D" screen.

Swash Detail		New-1	Normal	7.7V	1/7
MIXING RATE					
	DIR.A	DIR.B			
PIT→AIL	100 %	100 %			
PIT→ELE	100 %	100 %			
PIT→ELE2	100 %	100 %			

(1) PIT→AIL: collective pitch → aileron mixing rate

Going from MID to HIGH and MID to LOW collective pitch check that the swash plate is traveling flat throughout the entire range.

[Setting method] Operate the transmitter stick in the direction you want to set. Touch the button lit in green to enter the setting mode and adjust the mixing rate. Do the same for the other side.

Setting ranges: 30~150% **Initial value:** 100%

(2) PIT→ELE: collective pitch → elevator mixing rate

Going from MID to HIGH and MID to LOW collective pitch check that the swash plate is traveling flat throughout the entire range.

[Setting method] Operate the transmitter stick in the direction you want to set. Touch the button lit in green to enter the setting mode and adjust the mixing rate. Do the same for the other side.

Setting ranges: 30~150% **Initial value:** 100%

(3) PIT→ELE2: collective pitch → 2nd elevator mixing rate

This parameter adjusts the pitch to 2nd elevator mixing rate. The rates can both be adjusted individually for both full high and low collective positions. **Note:** This setting is only available if the **H4-xx swash mode** has been selected.

Setting ranges: 30~150% **Initial value:** 100%

Swash Detail		New-1	Normal	7.7V	2/7
MIXING RATE					
	DIR.A	DIR.B			
AIL→PIT	100 %	100 %			
AIL→ELE	100 %	100 %			
AIL→ELE2	100 %	100 %			

(4) AIL→PIT: aileron → collective pitch mixing rate

At the middle collective pitch, check that during right to left and left to right aileron action the swash plate is staying level on both the elevator and collective pitch axis. If the swash plate is rising or falling with aileron inputs.

[Setting method] Operate the transmitter stick in the direction you want to set. Touch the button lit in green to enter the setting mode and adjust the mixing rate. Do the same for the other side.

Setting ranges: 30~150% **Initial value:** 100%

(5) AIL→ELE: aileron → elevator mixing rate

This parameter adjusts the aileron to elevator mixing rate. The rate can be adjusted for left and right directions individually. **Note:** This setting is only available if the **H4-45 swash mode** has been selected.

Setting ranges: 30~150% **Initial value:** 100%

(6) AIL→ELE2: aileron → 2nd elevator mixing rate

This parameter adjusts the aileron to 2nd elevator mixing rate. The rate can be adjusted for left and right directions individually. **Note:** This setting is only available if the **H4-45 swash mode** has been selected.

Setting ranges: 30~150% **Initial value:** 100%

Swash Detail

Swash Detail		New-1 Normal	7.7V	3/7
MIXING RATE				
	DIR.A	DIR.B		
ELE→PIT	100 %	100 %	—	—
ELE→AIL	100 %	100 %	—	—
ELE→ELE2	100 %	100 %	—	—

(7) ELE→PIT: elevator→collective pitch mixing rate

During back and forward elevator inputs at middle collective, check if the swash plate is raising or lowering during the input.

[Setting method] Operate the transmitter stick in the direction you want to set. Touch the button lit in green to enter the setting mode and adjust the mixing rate. Do the same for the other side.

Note: This setting can not be used when H4-00 swash mode is selected.

Setting ranges: 30~150% **Initial value:** H3-120 = 50%, except H3-120 = 100%

(8) ELE→AIL: elevator→aileron mixing rate

While moving the elevator back and forth at middle collective, check to make sure the aileron axis is staying level.

[Setting method] Operate the transmitter stick in the direction you want to set. Touch the button lit in green to enter the setting mode and adjust the mixing rate. Do the same for the other side.

Note: This setting can not be used when H4-00 swash mode is selected.

Setting ranges: 30~150% **Initial value:** H3-120 = 50%, except H3-120 = 100%

(9) ELE→ELE2: elevator →2nd elevator mixing rate

This parameter adjusts the elevator to 2nd elevator mixing rate. The rate can be adjusted separately for up and down directions individually.

Note: This setting is only available if the H4-xx swash mode has been selected.

Setting ranges: 30~150% **Initial value:** 100%

Swash Detail		New-1 Normal	7.7V	4/7
COMPENSATION				
	DIR.A	DIR.B		
AIL High	0 %	0 %	—	—
AIL Low	0 %	0 %	—	—
AIL Dir	+		—	—

(10) AIL High / AIL Low: Linkage compensation aileron

At HIGH pitch and LOW pitch check to make sure that the swash plate is staying level on the elevator and collective axis when using aileron inputs. If the swash plate is rising or falling:

[Setting method] Operate the transmitter stick in the direction you want to set. Touch the button lit in green to enter the setting mode and adjust the mixing rate. Do the same for the other side.

Note: check all four directions: high/right; high/left; low/right; low/left

Setting ranges: 0~100% **Initial value:** 0%

(11) AIL Dir: Compensation direction of the aileron

If the above Data (+/-) correction from 0-100 is NOT in the correct compensation direction, change the value from [+] or [-].

Setting: +/- **Initial setting:** +

Swash Detail

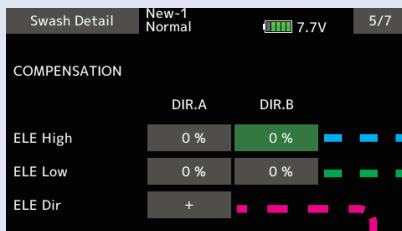

(12) ELE High / ELE Low: Linkage compensation elevator

At both the HIGH pitch and LOW pitch check to make sure that the swash plate is staying level on the aileron and collective axis when using elevator inputs. If the swash plate is rising or falling:

[Setting method] Operate the transmitter stick in the direction you want to set. Touch the button lit in green to enter the setting mode and adjust the mixing rate. Do the same for the other side.

Note: check all four directions: high/back; high/forward; low/back; low/forward.

Setting ranges: 0 ~ 100% **Initial value:** 0%

(13) ELE Dir: Compensation direction of the elevator

If the above Data (+/-) correction from 0-100 is NOT in the correct compensation direction, change the value from [+] or [-].

Setting: +/- **Initial setting:** +

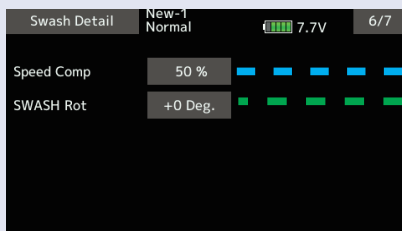

(14) Speed Comp: Speed compensation

In 120 degrees CCPM all servos do not travel the same distance on elevator input. Having previously set the ELE-PIT and ELE-AIL parameters, if during rapid movement of the elevator axis the swash plate is not staying level, use the "Speed Comp" button to match all servo speeds. **Note:** a (+ will slow the Aileron/Pitch Servo – will reduce speed comp on Aileron/Pitch Servo).

Setting ranges: 0 ~ 100% **Initial value:** H3-120 = 50%, except H3-120 = 0%

(15) SWASH Rot: Swash rotation

Using the "SWASH Rot" button, electronically add rotor head phasing to the swash plate controls. If possible, it is recommended to use mechanical phasing adjustment, but if the rotor head does not allow this and you feel that the model is NOT flying axially on each control input, this parameter can be used to adjust the pure reaction of each axis in flight. (Typically advanced phasing on clockwise rotor disk and a slight clockwise increase in swash plate alignment vs rotor axle are needed to create an axial reaction. The opposite is true for a counterclockwise rotor disk model.)

Setting ranges: -90 deg ~ +90 deg **Initial value:** +0 deg



(16) RESET: Swash detail data reset

This resets the "Swash Detail" setting back to the defaults.

Governor Expert

This menu sets the Governor Expert parameters, allowing the user to further refine the governor settings.

"Governor Expert" screen from the "EXPERT MENU 3D" screen.

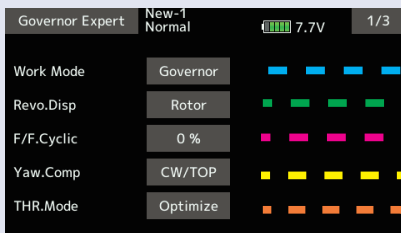

(1) Work Mode: Governor working mode

Sets the governing type mode.

- **GOVERNOR** (Governor Mode) – RPM is entirely controlled by the GOV once it has engaged. The GOV will do whatever it takes to hold a constant RPM throughout flight.
- **Rev. Lmt** (Limiter Mode) – Throttle control follows the throttle curves to advance the throttle position during flight, but controls the RPM during throttle reduction by not letting the RPM overspeed past the set RPM. When the Rev.Lmt mode is selected, the menu (5) "THR. Mode" should be set to Tx.Curve mode.

Setting: GOVERNOR/Rev. Lmt **Initial setting:** GOVERNOR

(2) Revo Disp: Governor working mode

This enables the user to display either the desired rotor RPM or the Engine RPM accordingly.

Setting: Rotor/Engine **Initial setting:** Rotor

(3) F/F. Cyclic: Feed Forward from Cyclic

Increasing the value will add throttle with cyclic commands to aid in RPM stability.

Setting ranges: 0~100% **Initial value:** 0%

(4) Yaw. Comp: Governor working mode

Yaw compensation allows the governor to more rapidly correct for changes in power demands of the model resulting from yaw input. Set the mode to match the gyro installation direction. Select from: CW/TOP, CW/BOTM, CCW/TOP, CCW/BOTM.

Note: if the user has selected the governor only mode, this parameter is inhibited.

Revolution fluctuation in the case of pirouettes

The governor detects the rpm via the revolution sensor mounted in the engine section. During a pirouettes, the helicopter itself rotates, so that its pirouettes speed is added (reduced) to the engine speed. Therefore, the main rotor speed will fluctuate accordingly. Since the CGY has a gyro, it can accurately measure the pirouette speed. The yaw rate correction is thus determined by a combination of gyro function and governor function.

CW: clockwise rotor direction

CCW: counter clockwise rotor direction

TOP: Gyro top/name emblem facing up

BOTM: Gyro top/name emblem facing down

Setting: CW/TOP, CW/BOTM, CCW/TOP, CCW/BOTM **Initial setting:** CW/TOP

(5) THR. Mode: Throttle data mode

This parameter selects the throttle input operation.

Optimize:

CGY sets the throttle input signal to optimum. There is no need to consider the throttle curve setting on the transmitter.

Fixed:

This is the suggested mode for use with electric motors. This setting ensures that there is a fixed throttle input as is related to the helicopter revolution.

Tx.Curve:

If this mode is selected, the CGY uses the exact throttle input from the transmitter. As such, the throttle curve setting on the transmitter is required.

Note: when the Rev.Lmt mode is selected, this mode should also be selected.

Setting: GOVERNOR/Rev. Lmt **Initial setting:** GOVERNOR

Governor Expert

Governor Expert	New-1 Normal	7.7V	2/3
Revo.Up Dly	8 Frm		
Revo.Dn Dly	10 Frm		
Start Dly	5 Frm		
Gov.On.Revo	60 %		
BFS.Volt	3.8 V		

(6) Revo. Up Dly: Revolution change up delay

How quickly the RPM changes when increasing RPM between two different RPM conditions and flight modes. A higher number slows the RPM change rate; a lower value speeds up the RPM change rate.

Setting ranges: 2~40Frm Initial value: 8Frm

(7) Revo. Dn Dly: Revolution change down delay

How quickly the RPM changes when reducing RPM between two different RPM conditions and flight modes. A higher number slows the RPM change rate; a lower value speeds up the RPM change rate.

Setting ranges: 2~40Frm Initial value: 10Frm

(8) Start Dly: Start delay

How quickly the RPM stabilizes to the set RPM from when the GOV is turned ON. A higher value slows down the spool up rate; a lower value speeds up the spool up rate.

Setting ranges: 2~20Frm Initial value: 5Frm

(9) Gov. On. Revo: Governor ON revolution setting

This parameter tells the governor at what percentage of the set rpm it is to become active. The default value is 60%. In this case, the governor will not engage until the engine rpm reaches 60% of the set rpm. If you feel that the time for governor engagement is too slow, decrease the value to 50 ~ 55%. The starting time will be faster.

Setting ranges: 50~90% Initial value: 60%

(10) BFS. Volt: Battery F/S voltage setting

This parameter sets the battery fail safe and low battery alarm voltage levels, or thresholds. Set the proper voltage as determined by the battery type. The battery characteristics are different depending on cell type/chemistry.

Suggested setting voltages are as follows.

- 4 cells NiCd or NiMH (Normal: 4.8v) = 3.8v
- 2 cells LiFe (Normal: 6.6v) = 6.0~6.2v
- 2 cells LiPo (Normal: 7.4v) = 7.2~7.4v

Governor Expert	New-1 Normal	7.7V	3/3
Low.Revo	1000rpm	Reset	Governor

(11) Low. Revo: Low revolution setting

This value is set to assign the lowest possible governing RPM. If the RPM is below, or can not reach this RPM, the governor will not engage. Select between either 1,000 rpm or 700 rpm. It corresponds also to a helicopter with a rotor speed of 1,000 rpm or less, such as a large gas machine.

Setting: 700/1,000 rpm Initial setting: 1000rpm

(12) RESET : Governor expert data reset







This resets the "Governor Expert" setting back to the defaults.

MODEL MENU (Multicopter functions)

The dedicated mixes, etc. usable when multicopter model type is selected are displayed in this Model menu functions section.

These dedicated mixes can be set for each flight condition, as required. When you want to use the system by switching the settings for each condition by switch or stick position, use the Condition select function to add flight conditions. (Up to 8 conditions can be used)

Model menu (Multicopter) functions table

 Servo monitor	Displays the servo test and operation position
 Condition select	Flight conditions addition, deletion, copy, condition renaming, and condition delay can be set.
 AFR	Sets the angle and curve of all the operation functions.
 Dual rate	D/R curve which can be switched with a switch, etc. can also be added.
 Program. mixes	Program mixing which can be freely customized. Up to 10 mixes can be used for each condition.
 Gyro	Used to switch gyro sensitivity

Condition select

Flight condition's addition, deletion, copy, condition renaming, and condition delay can be set. [All model types]

The functions in the Model menu can be used by switching the settings of up to 8 flight conditions by using the Condition select function to add flight conditions. Add conditions, as required.

When you do not want to use the Condition select function, this setting is unnecessary. In this case, use the flight conditions assigned at initial setting.

- Since switching by stick and lever position, in addition to ordinary toggle switch, is possible as the flight condition selector switch, this function can be linked with other operations.
- A Condition Delay function can be set. Unnecessary fuselage motion generated when there are sudden changes in the servo

positions and when there are variations in the operating time between channels during condition switching can be suppressed. The delay can be set for each channel.

When setting the delay function at the switching destination condition, the related function changes after a delay corresponding to the set amount.

- When multiple conditions were set, their operation priority can be freely changed.
- The condition name can be changed. The selected condition name is displayed on the screen. When a condition has been added, give it a name which can be easily confirmed.

- Select [Condition select] at the model menu and call the setup screen shown below.

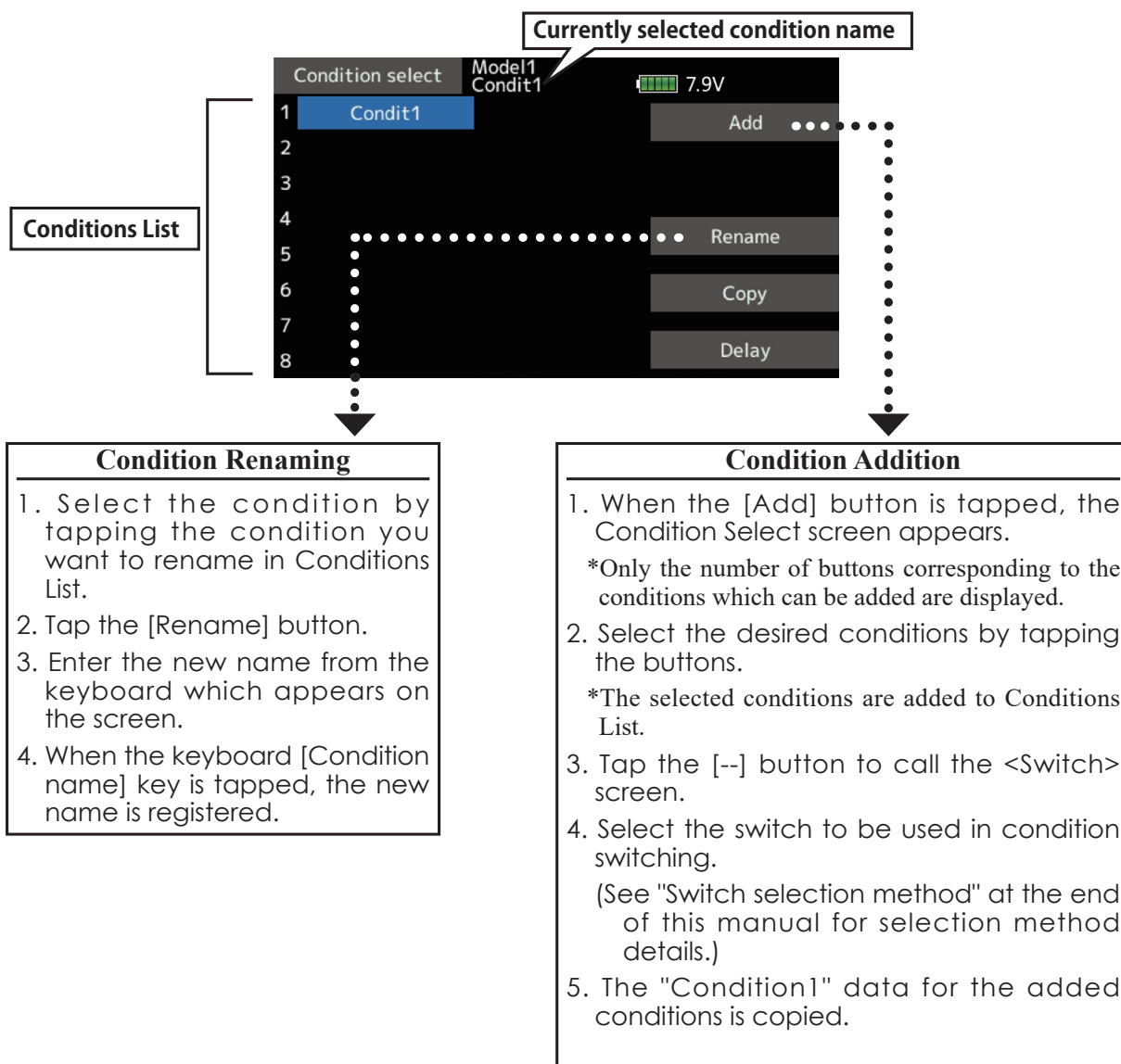

Condition Copy

1. Tap the [Copy] button. The Copy screen appears.
2. Select the condition by tapping the button of the copy source conditions.
3. Next, select the condition by tapping the copy destination condition.
4. Tap the [Copy] button.
5. When the [Yes] button is tapped, the data is copied. (To abort copying, tap the [No] button.)

Condition Remove

1. Select the condition by tapping the condition you want to reset in Conditions List.
2. Tap the [Remove] button.
3. When the [Yes] button is tapped, the condition is reset. (To abort resetting, tap the [No] button.)

Priority change

1. Tap the condition whose priority you want to change in Conditions List.
2. Change the priority with the priority [Δ] or [∇] button. (The last condition has the highest priority.)

*The initial setting condition cannot be moved. It has the lowest priority.

Condition delay setting

1. Switch to the condition you want to set.
2. Tap the Delay button of the channel you want to set.
3. Use the value input buttons to set the delay.
 - Initial value: 0
 - Adjustment range: 0~27 (maximum delay)

Ch	Function	Delay	Gr.
1	Aileron	0	Gr.
2	Elevator	0	Gr.
3	Throttle	0	Gr.
4	Rudder	0	Gr.
5	Gyro	0	Gr.
6	Gyro2	0	Gr.

AFR

The angle and curve of each operation function can be set. [All model types]

AFR function is used to adjust the throw and operation curve of the stick, lever, and switch functions for each flight condition.

This is normally used after End Point has defined the maximum throw. When mixing is applied from one channel to another channel, both channels can be adjusted at the same time by adjusting the operation rate through the AFR function.

- Operation curve adjustment: Three types of curves (EXP1, EXP2, and Point) can be selected. A maximum 17 points curve can be used for the point curve type. (Initial setting: 9 points) The number of points can also be increased and decreased and curves from complex curves to simple curves can be used.
- Operation speed adjustment: The operation speed of each function when the function is operated (including at flight condition switching) can be adjusted. The function operates smoothly at a constant speed corresponding to the set speed.

When D/R is turned ON, the display will show "D/R----", and the rudder angle (rate) and EXP can be set when D/R is ON.

- Select [AFR] at the model menu and call the setup screen shown below.

•Return to Model menu

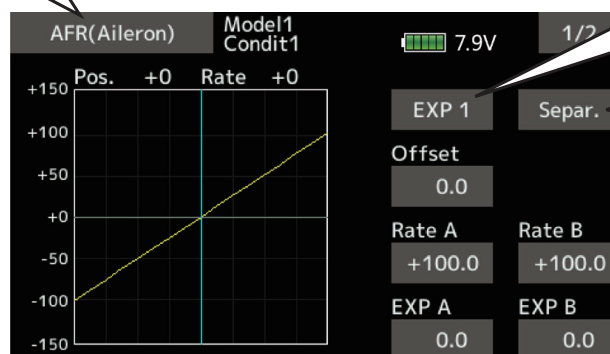

Curve select EXP1, EXP2, Point curve

Curve select Separately ⇔ Combination (Left and right symmetrical curve.)

Left/right, Up/down, overall adjustment at Rate A and Rate B

● Operation curve setting (For a description of the setting method, see the description at the back of this manual.)

Function selection

1. When the function select button is tapped, a selection screen appears.
2. Select the function you want to set at the selection screen.

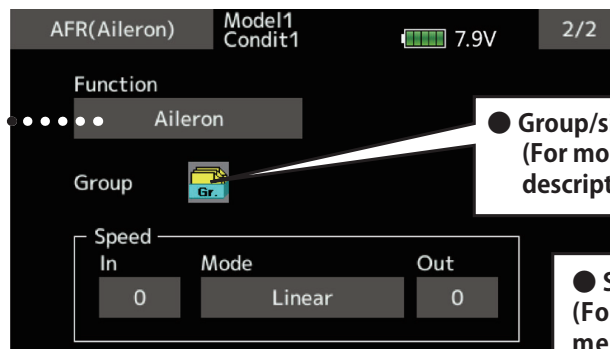

● Group/single mode switch (Gr./Sngl) (For more information, see the description at the back of this manual.)

● Servo speed setting (For a description of the setting method, see the description at the back of this manual.)

Dual rate

D/R curves which can be switched by switch, etc. can be added. The curve can be adjusted by the AFR function.

- Up to 6 rates can be added for each condition.
- D/R is set for each condition and is not reflected at other conditions.
- D/R at the top of the D/R list has priority.

- Select [Dual rate] at the model menu and call the setup screen shown below.

- Return to Model menu

Dual rate		Model1 Condit1	7.9V	
	Status	Function	Switch	
1	D/R 1	INH	Aileron	SD
2	D/R 2	INH	Elevator	SA
3	D/R 3	INH	Rudder	SB
4	D/R 4	INH	Aileron	--
5	D/R 5	INH	Aileron	--
6	D/R 6	INH	Aileron	--

The ON/OFF switch of dual rate is chosen.

Activate the D/R function by tapping the [INH].

When the function select button is tapped, a selection screen appears. Select the function you want to set at the selection screen.

 **Rate, EXP settings are on AFR function**

- **Setting rudder angle, EXP**
On this D/R screen you can set functions and switchover switches. Rudder angle (rate) and EXP settings are performed on the AFR screen when the D/R switch is ON.

Program. mixes

Program mixing which can be freely customized. Up to 10 mixings can be used for each condition. [All model types]

Programmable mixing may be used to correct undesired tendencies of the aircraft, and it may also be used for unusual control configurations. Mixing means that the motion of a command channel, called the "master," is added to the motion of the mixed channel, called "slave."

You may choose to have the Masters trim added to the Slave channel response, if you desire ("Trim" setting). The mixing curve can be changed so that the undesired tendencies can be corrected effectively by setting the EXP1/EXP2/Point modes.

Offset-type mixing applies a fixed offset or preset to the programmed channel servo operation and may control up to four circuits simultaneously.

The Programmable mixing includes a powerful link function, which allows Programmable mixing to be linked with the special mixing functions, or with other programmable mixing functions. The link function can be set up for Master and Slave channel individually.

- Tap the [Prog. mixes] button in the Model menu to call the setup screen shown below.

•Return to Model menu →

Channel	Mixing	Mode	Gr.
1	Inhibit	Offset	Gr.
2	Inhibit	Mixing	Gr.
3	Inhibit	Mixing	Gr.
4	Inhibit	Mixing	Gr.
5	Inhibit	Mixing	Gr.

● **Group/single mode switch (Gr./Sngl)**
(For more information, see the description at the back of this manual.)

After this function is activated, the master and slave function names (or offset mixing) are displayed.

Mixing/Offset mode switch

● **Operation curve setting**
(For a description of the setting method, see the description at the back of this manual.)

Activate the function by tapping the [INH].

The ON/OFF switch of prog. mixes is chosen.

Master function (or Stick, Switch, Dial) is chosen.

Slave function is chosen.

Servo speed setting

Trim mode setting ON/OFF.

Fine tuning trim setting

The on time (start/stop time) can be set up to 4 seconds. It is useful for landing gear control of the jet or scale plane, etc.

Setting methods

●Group/single mode selection

Activating functions for only the selected conditions:

1. Tap the [Gr] button and switch to the [Sngl] mode.

*Each time the button is tapped, it toggles between the Gr and Sngl modes.

●Mixing mode selection

Using the offset mode:

1. Tap the Mode button and switch to the Offset mode.

*Each time the button is tapped, it toggles between the Mixing and Offset modes.

●Mixing setup screen selection

1. Tap the button of the mixing you want to set. The mixing setup screen is displayed. Activate the function.

2. Activate the function by tapping the [INH] button.

*Each time this button is tapped, it toggles between [INH] and [ON/OFF].

●Mixing ON/OFF switch setting and ON/OFF direction switching

*An ON/OFF switch is not set even when the function is activated.

1. When you want to turn mixing ON/OFF by switch, tap the [--] button to call the <Switch> screen and then select the switch and its ON direction.

*For a description of the selection method, see [Switch setting method] at the back of this manual.

●Master channel setting (except offset type mixing)

1. Tap the Master button to call the Function menu and select the master channel.

2. To link this mixing with other mixing, tap the "Link" button.

*Each time the button is tapped, it toggles between mixing direction + and - and "OFF" (no link).

*Master channel control can be set to stick, VR, and other simple travels which do not include End point, AFR, D/R, mixing setting, etc. In this case, display the <Function,H/W> screen by tapping the [Stick, Switch, Dial] button and then select master channel side control.

●Slave channel setting

1. Tap the Slave button to call the Function menu and select the slave channel.

2. To link this mixing with other mixing, tap the "Link" button.

*Each time the button is pressed, it toggles between mixing direction + and - and "OFF" (no link).

●Trim mode ON/OFF setting

1. To turn the trim mode ON/OFF, tap the Trim button on the screen.

*When mixing includes master side trim, set the Trim button to [ON]. When mixing does not include master side trim, set the Trim button to [OFF].

*Each time this button is pressed, it toggles between [ON] and [OFF].

*This is effective when the master channel is set by Function.

●Mixing curve type selection

1. Tap the curve type selection button of the curve type you want to use to display the selection screen. Then, select the curve you want to use.

*For a description of the curve setting method, see the description at the back of this manual.

●Fine tuning trim setting

1. When using the curve fine tuning function, tap the [--] button of the Fine Tuning item to call the <Switch> screen and then select the lever, VR, etc. you want to use.

*For a description of the fine tuning trim setting method, see the description at the back of this manual.

●Servo speed setting

1. When setting the servo speed, tap the speed button. The Servo speed setup screen is displayed.

*For a description of the servo speed setting method, see the description at the back of this manual.

*Offset mixing changes the speed. Use the Speed In and Speed Out buttons to readjust the speed.

The mixing switch can set a delay with a different rate at starting and stopping.

*This function is inactive when a mixing switch is not set.

Gyro

This function is used when a Futaba GY Series gyro is used to stabilize the aircraft's attitude. The sensitivity and operation mode (Normal mode/GY mode) can be switched with a switch.

- Three rates (Rate 1/Rate 2/Rate 3) can be switched.
- Up to 3 axes (Gyro/Gyro 2/Gyro 3) can be simultaneously controlled.

*Initial setting does not assign a sensitivity channel. Use the Function menu of the Linkage menu to assign the sensitivity channel (Gyro/Gyro2/Gyro3) used to a vacant channel beforehand.

Set [Control] and [Trim] other than Function to [--].

- Select [Gyro] at the model menu and call the setup screen shown below.

•Return to Model menu →

Tapping this will change INH to either ON or OFF and enable operation. Adjustment of the three rates (sensitivity) and switching between Normal and AVCS is possible.

		Rate 1		Rate 2		Rate 3	
	INH	Gr.	Gr.	Gr.	Gr.	Gr.	Gr.
	Type	Switch	Switch	Switch	Switch	Switch	Switch
	GY	--	--	--	--	--	--
	Mode	Rate	Rate	Rate	Rate	Rate	Rate
GYRO	Normal	0	0	0	0	0	0
GYR2	Normal	0	0	0	0	0	0
GYR3	Normal	0	0	0	0	0	0

The operation mode (AVCS/NOR) and sensitivity of the 3 axes Gyro/Gyro2/Gyro3 can be set.

Condition group/ single mode selection (Gr. /Sngl)

The ON/OFF switch of gyro is chosen.

3 rate (gyro gain) adjustment

- Three rates (Rate 1/Rate 2/Rate 3) can be used.
Tap to the [Rate] item. Adjust the rate.
- When using this function, Tap [INH].
- When a Futaba GY gyro is used, when [GY] type is selected, the sensitivity set value is directly read in both the AVCS and Normal modes.
- When setting a switch, tap the Switch item and tap the "--" button to call the selection screen, and then select the switch and set its ON direction. (For a description of the switch selection method, see the description at the end of this manual.)

Common operations used in function setup screen

This section describes the functions often used at the function setup screen. Refer to it when setting each function.

Operations value setting

EXP B
-100.0

Pressing and holding a value will return it to its default setting.

Tapping the value setting buttons on each screen will cause value input buttons to appear at the top of the panel.

Value input buttons display at the top of the panel

Large change in value

Small change in value

Large change in value

Operations related to flight conditions

Group/single mode switching (Gr/Singl)

When setting multiple flight conditions, linking the setting contents with all conditions (group mode) or setting independently (single mode) can be selected. The mode can be changed at the [Gr] item on each setup screen.

[Group/single mode switching]

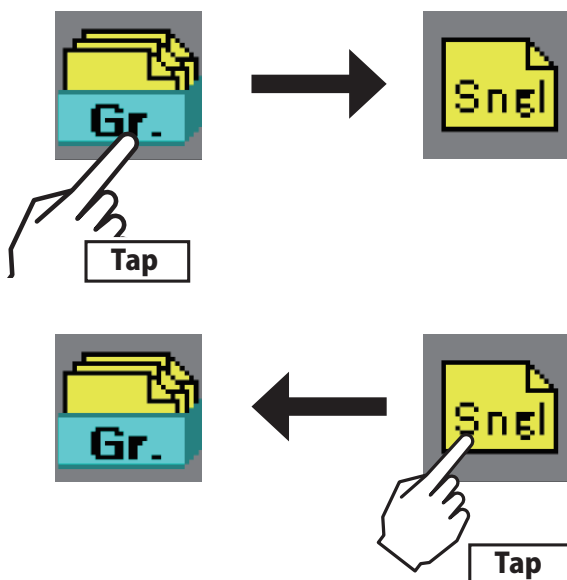

- Group mode (Gr)
The same setting contents are set to all the flight conditions.
- Single mode (Singl)
Set this mode when the setting contents are not linked with other conditions.

Condition delay setting

Unnecessary fuselage motion generated when there are sudden changes in the servo position and variations in the operating time between channels can be suppressed by using the condition delay function of the condition select function [Condition select].

When the delay function is set at the switching destination condition, a delay corresponding to that amount is applied and the related functions change smoothly.

[Setting method]



1. Switch to the condition you want to set and tap the delay[0 (value)].
2. Set the delay using the "▼▼" "▼" "▲" "▲▲" buttons
Initial value: 0
Adjustment range: 0~27 (maximum delay)
(When the value is tapped, the delay is reset to the initial value.)

Operations related to fine tuning VR

Operation mode selection
 *The operation modes which can be selected depend on the function.

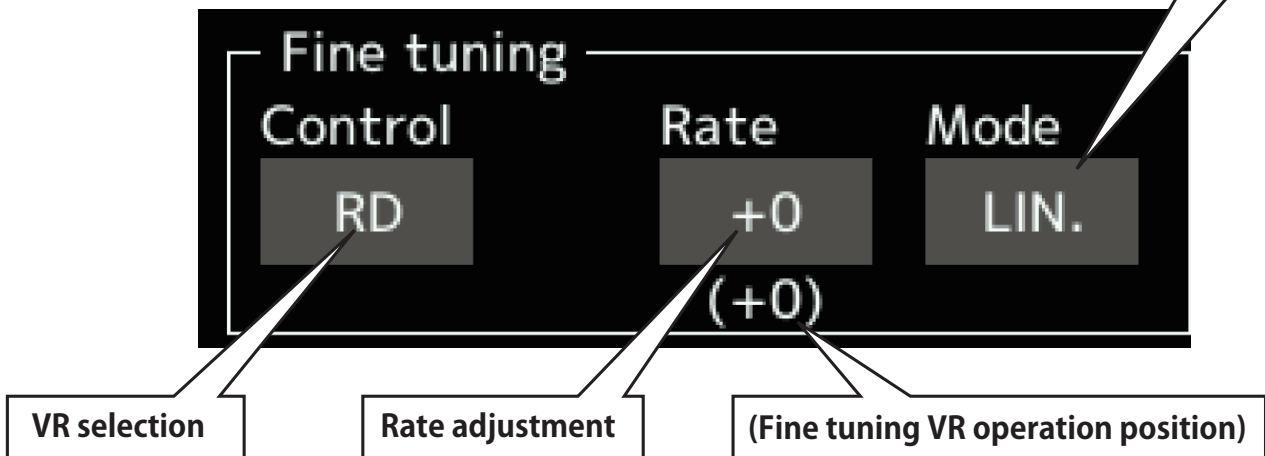

[Setting method]

1. Control selection
 Tap the [Control] "--" button to call the <Hardware select> screen, and then select the switch and its ON direction.
2. Mode selection
 Tap the [Mode] button, and then select the mode ([LIN.], [ATL+], [ATL-], or [SYM.]).
3. Rate adjustment
 Tap the [Rate] "value" button.
 Set the rate using the "▼▼" "▼" "▲▲" buttons

Initial value: 0%

Adjustment range: -100%~+100%

(When the value is tapped, the rate is reset to the initial value.)

[Fine tuning VR operation mode]

- [LIN.] Mixing rate 0% at center of VR. When the VR is turned clockwise and counterclockwise, the mixing rate increases and decreases, respectively.
- [ATL+] Mixing rate 0% at left end of VR. When the VR is turned, the mixing rate increases.
- [ATL-] Mixing rate 0% at right end of VR. When the VR is turned, the mixing rate increases.
- [SYM.] When the VR is turned to the left or right of the neutral position, the mixing rate increases.

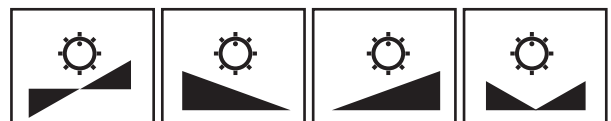

LIN. ATL+ ATL- SYM.

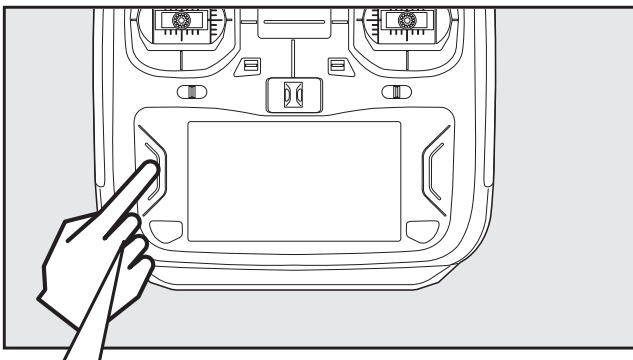

After setting, press a HOME/EXIT button

Operations related to servo speed

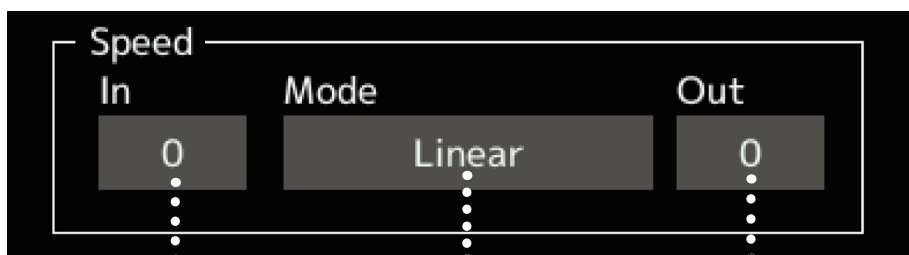

(First) 0 ~ 27 (Slowly)

Servo speed setting

The servo speed at each function operation (including flight condition switching) can be adjusted. The servos operate smoothly at a fixed speed corresponding to the set speed. The operating speed (In side) and return speed (Out side) can be set individually.

Switch the operation mode according to the set function.

"Symmetry" mode: Used with ailerons and other self neutral functions.

"Linear" mode: Used with functions which hold the operation position of the throttle and switch channel, etc.

[Setting method]

1. Select the mode ([Linear] or [Symmetry]). Each time the button is tapped, it toggles between [Linear] and [Symmetry].
2. Tap the In or Out Speed button and set the servo speed.

Initial value: 0

Setting range: 0~27

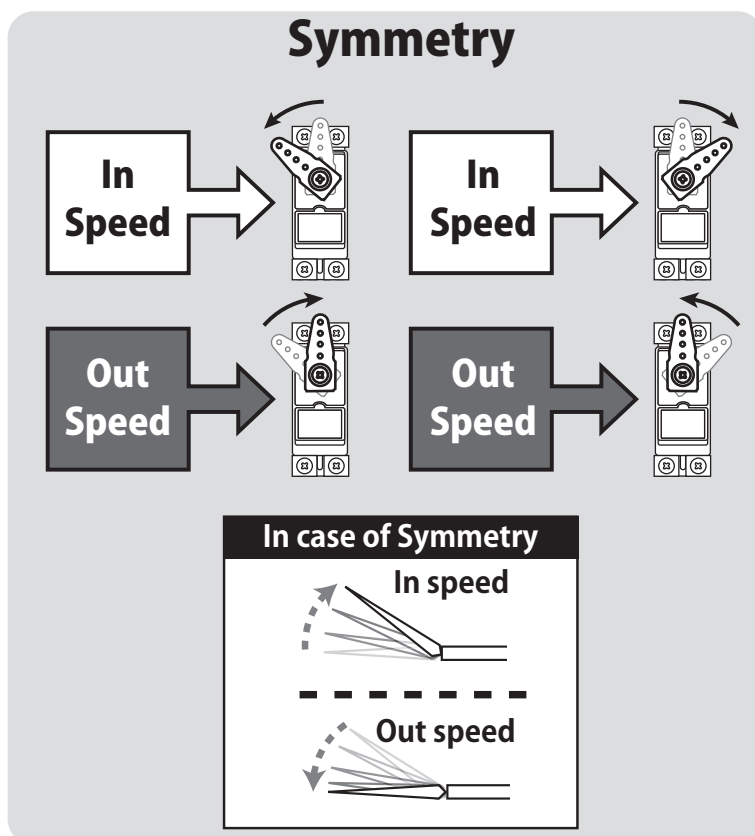
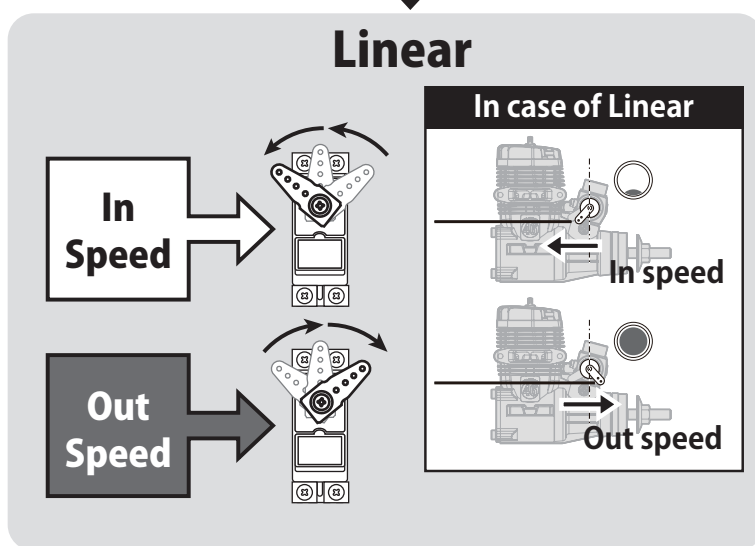

Curve setting operation

This section describes the setting procedure of curves which are used with the AFR function and each mixing function.

Curve type selection

Four types of curves (EXP1, EXP2, Point and Spline) can be selected.

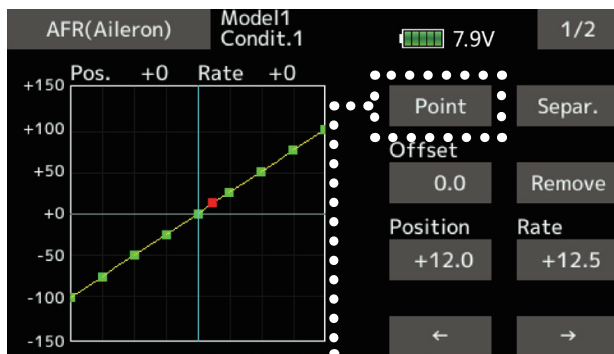

Curve type selection

1. Tap the button of the curve type you want to use.

*The curve type changes and the display returns to the original screen.

[EXP1]: EXP1 curve
[EXP2]: EXP2 curve
[Point]: point curve
[Spline]: spline curve

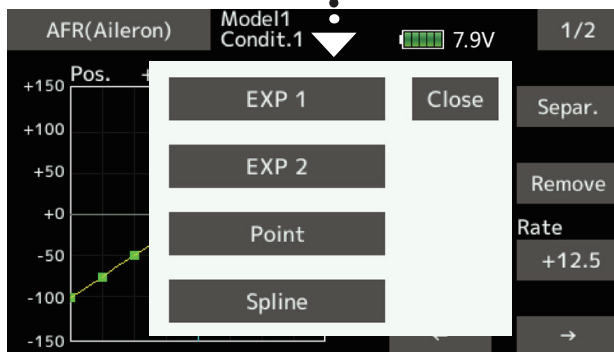

Setting by curve type

When the curve type is selected as described above, adjustment items corresponding to the curve type appear on the screen. Adjust each curve as described below.

EXP1/EXP2 curve adjustment

(EXP1 curve)

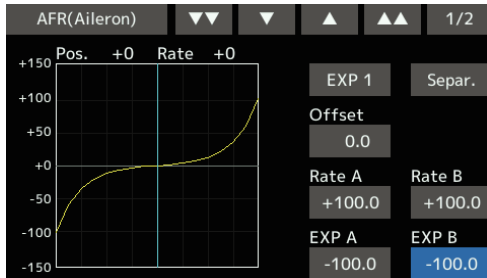

Using the EXP1 curve is effective in smoothing starting of the ailerons, elevator, rudder, etc.

(EXP2 curve)

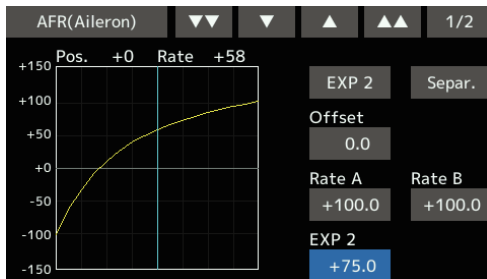

Using the EXP2 curve is effective in engine rise and other engine control.

The curve left and right rates ([Rate A], [Rate B]) and EXP curve rate ([EXP A], [EXP B]) can be adjusted individually. ([EXP] for EXP2)

The curve can also be offset horizontally ([Offset]) in the vertical direction.

[Rate setting]

1. Tap to the [Rate A], [Rate B], [EXP A], or [EXP B] setting item.
2. Set the rate using the "▼▼" "▼" "▲" "▲▲" buttons

Initial value: +100.0% (rate)/+0.0% (EXP rate)

*Initial value differs depending on function.

Adjustment range: -200.0~+200.0% (rate)/-100.0~+100.0% (EXP rate)

(When the value is tapped, the rate is reset to the initial value.)

[Offsetting the curve horizontally in the vertical direction]

1. Tap to the [Offset] setting item.
2. Move the curve in the vertical direction using the "▼▼" "▼" "▲" "▲▲" buttons
Initial value: +0.0%
(When the value is tapped, the rate is reset to the initial value.)

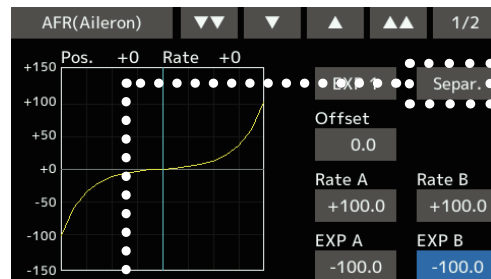

*[Separ.] mode: Normal setting

*[Comb.] mode: Creates a left and right symmetrical curve.

Point curves or spline curves of up to 11/17 points can be used. (Initial value: 7/9 points) The set points can be freely increased, decreased, and offset.

Point addition method

1. Open the screen of a mixing curve with the curve function.

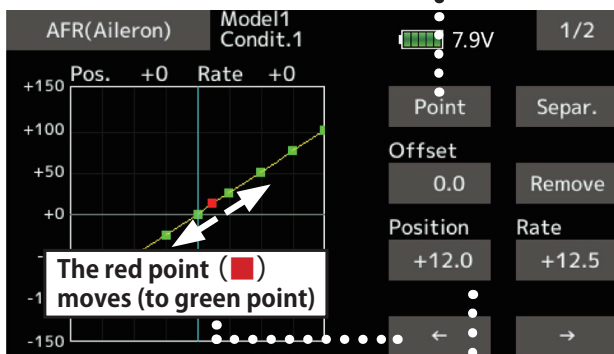
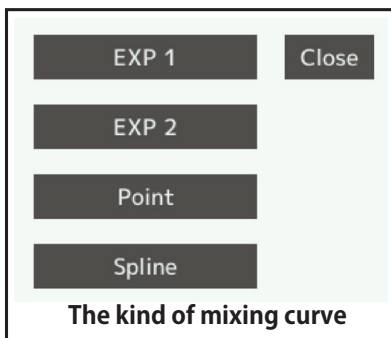

2. Tap the "Position" button.

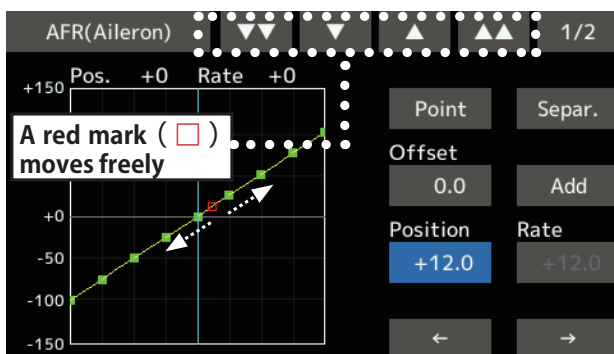

3. Tap the "▼▼" "▼" "▲" "▲▲" button and select the position (mark □) you want to add.

4. When the "Add" is tapped, the point is added. (□) → (■)
*A new point is created.

5. Press "Rate" and use the up/down arrows to adjust the rate points up or down.

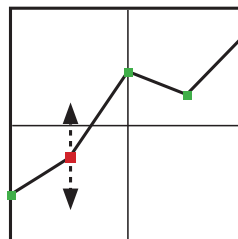

Point deletion method

1. Use the move between points button [←] or [→] and select the point. (The red point ■ is the selected point.)

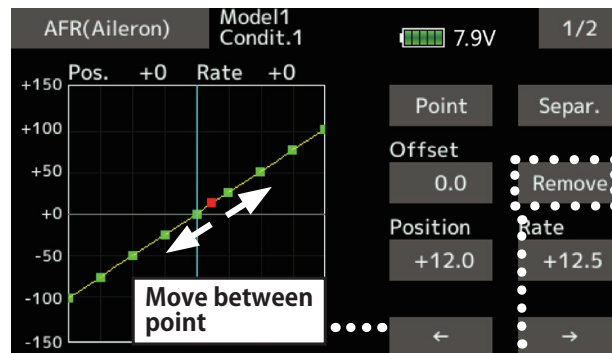

2. Tap the [Remove] button. (The selected point becomes an outlined point □)

3. Use the move between points button [←] or [→].

Curve setting operation Spline curve

A smoother curve is made.
Setting method is same at spline and point.

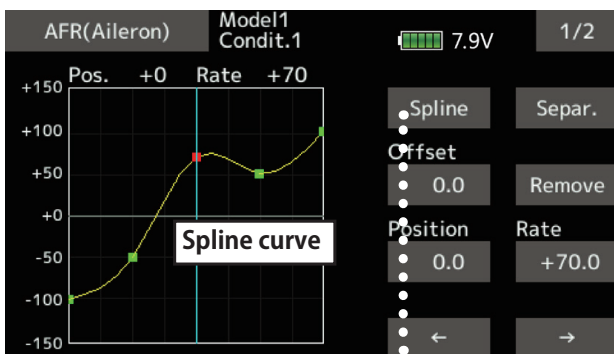
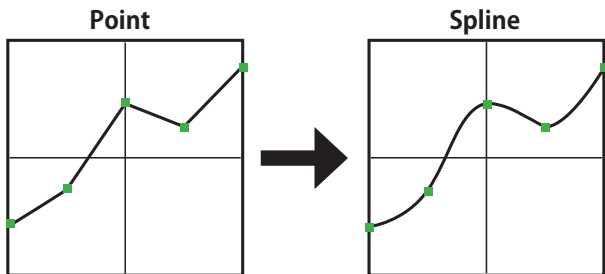

EXP 1 Close

EXP 2

Point

Spline

The kind of mixing curve

Up to 11 or 17 points curve can be used.
(differs with function)

Initial point number: 9 points (17 points curve), 7 points (11 points curve)

*The set points can be freely increased, decreased, and offset.

[Rate adjustment of each point]

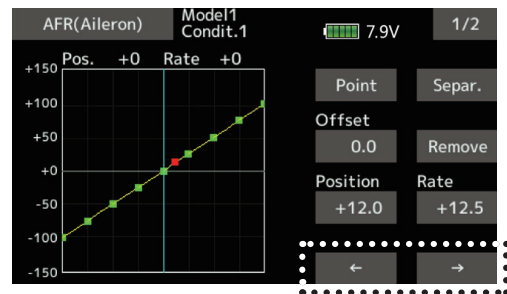

1. Tap to the item and select the point whose rate you want to set.

*The mark on the curve shows the currently selected point.

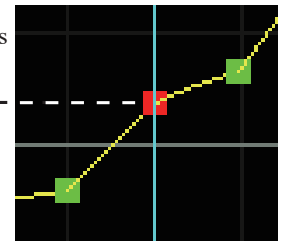

2. Tap to the [Rate] item. And set the rate using the "▼▼" "▼" "▲" "▲▲" buttons

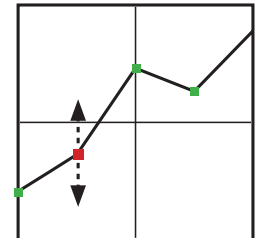

Repeat steps 1 through 2 and adjust the curve.

Point curve (Point) adjustment

(Point)

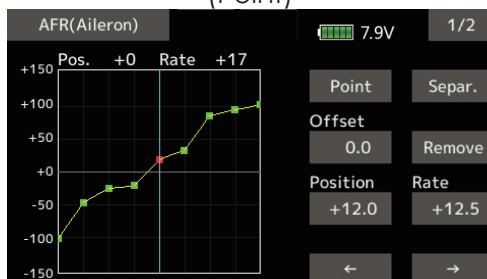

Up to 11 or 17 points curve can be used. (differs with function)

Initial point number: 9 points (17 points curve), 7 points (11 points curve)

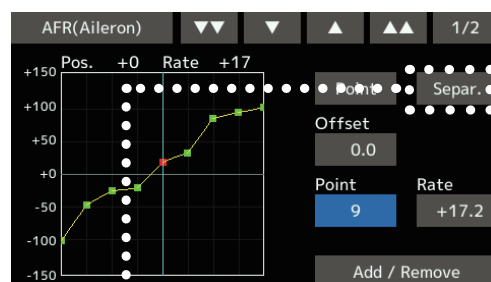

*[Separ.] mode: Normal setting

*[Comb.] mode: Creates a left and right symmetrical curve.

Switch selection method

The various functions used in the T16IZ SUPER can be selected by switch. The switch (including when stick, trim lever, or VR are used as a switch) setting method is common to all functions.

Switch selection

When a switch is selected at a mixing function, etc., the selection screen shown below is called.

(Switch selection screen example)

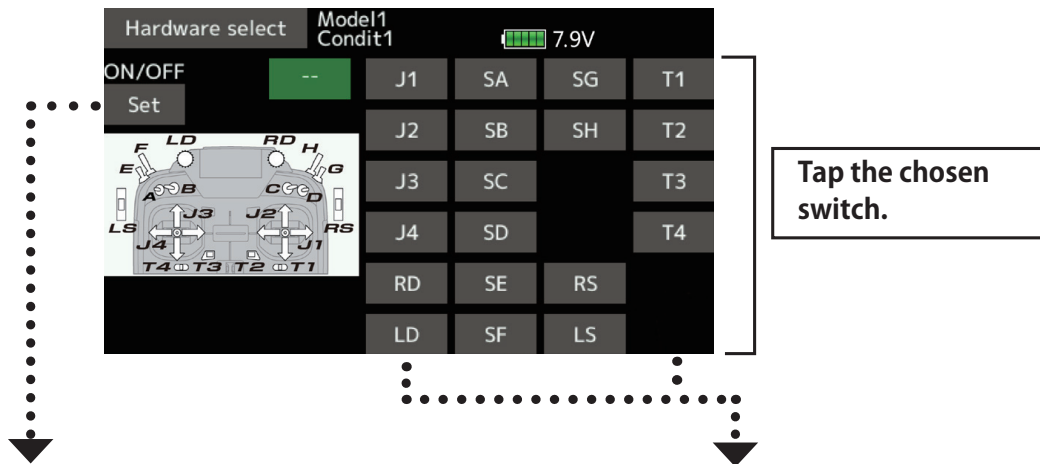

When switch is selected

Switch ON/OFF setting is possible at each position.

1. When the ON/OFF "Set" position switch is tapped after the switch was selected, the screen shown below appears.

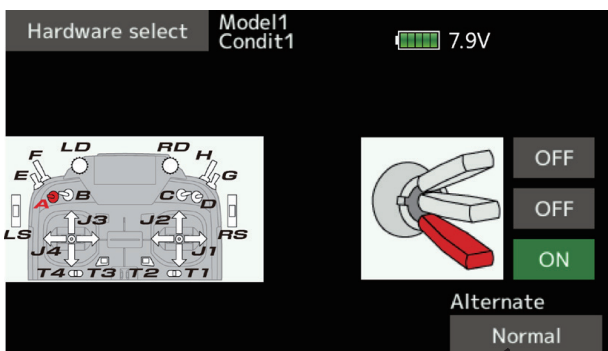

Normal or Alternate: Alternate switching mode is available depending on mixing function.

When stick, trim lever, or VR is selected.

When a stick, trim lever, or VR is used as a switch, the following 4 modes can be selected.

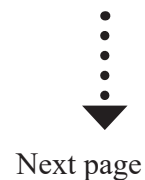

Next page

- *When the button of each position is tapped, it toggles between ON and OFF.
2. Tap the button and set to the ON position.
 3. Close the screen by tapping [Hardware select].

Hysteresis-type and box-type can be selected in a hardware select screen.

When a stick, trim lever, or VR is used as a switch, the following 4 modes can be selected.

◆ **Linear • Hysteresis mode**

This setting method selects function ON/OFF based on the set point. Hysteresis (dead band) can be set to ON and OFF. The ON and OFF positions can be reversed with the Reverse button.

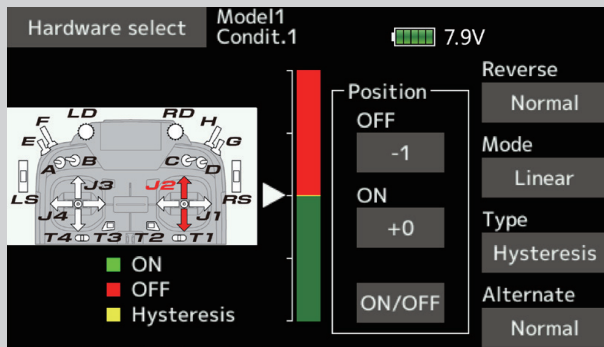

◆ **Symmetry • Hysteresis mode**

The operation is the same as the linear hysteresis mode, but left and right (up and down) operations are symmetrical about the neutral position. For example, when you want to switch DR1 with the aileron stick, when the stick is moved to the left or right, DR1 can be turned ON at the same left and right position.

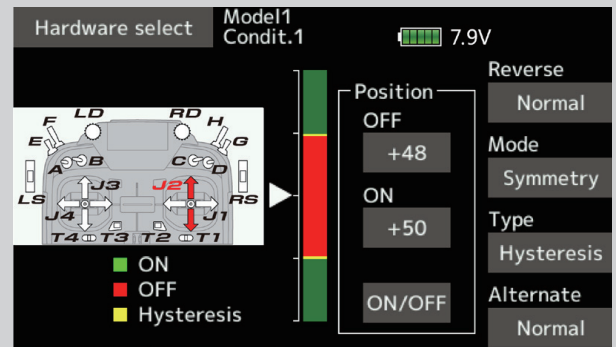

◆ **Linear • Box mode**

This mode turns on the switch within a range of 2 points. Each point can be set. The ON and OFF positions can be reversed with the Reverse switch.

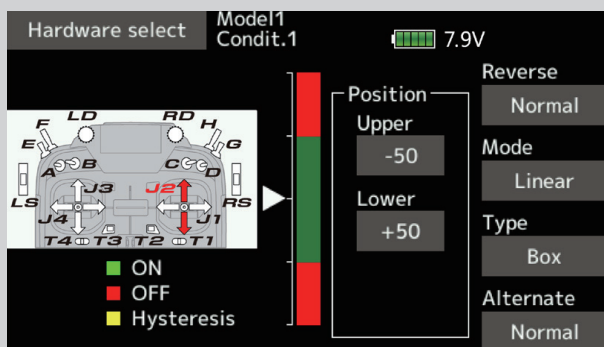

◆ **Symmetry • Box mode**

The operation is the same as the linear box mode, but left and right (up and down) operation is symmetrical about the neutral position.

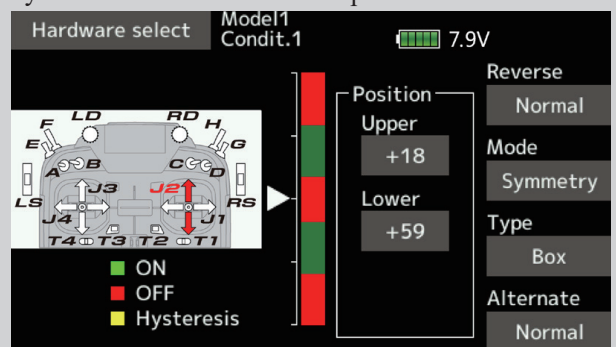

When shifting the ON/OFF point

The ON/OFF and hysteresis (dead band) boundary point (there are 2 points: top and bottom) position can be shifted. ON/OFF is possible at a free position.

- ◆ Area Green : ON
- ◆ Area Red : OFF
- ◆ Area Yellow : Hysteresis (Dead band)

[Setting method]

1. Move the stick, etc. to the point you want to shift and touch the [ON/OFF] button. The boundary points change.

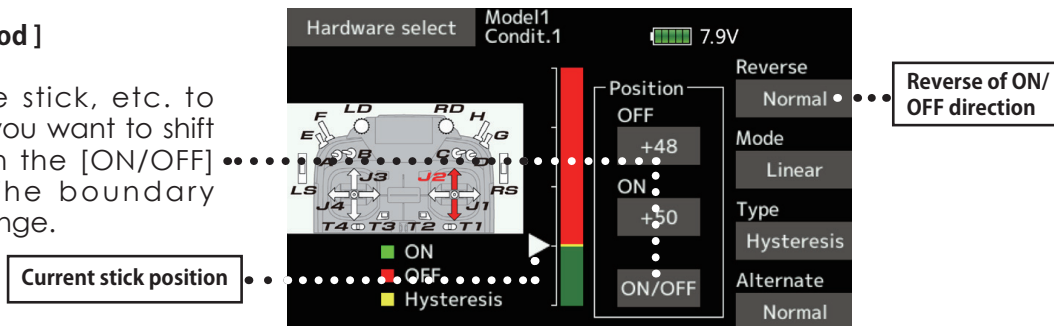

[Setting method] → Box Type

1. Move the stick to the point you want to shift upper side.
2. Touch the [Upper] button. The boundary points change.
3. Move the stick to the point you want to shift lower side.
4. Touch the [Lower] button. The boundary points change.

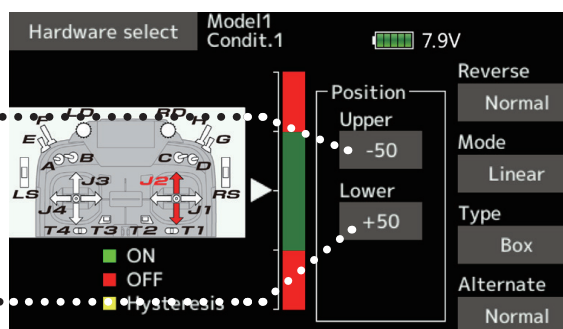

● Symmetry

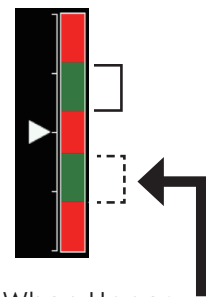

When Upper (Lower) is set, at the same time, Lower (Upper) is also set.

Hysteresis : Hysteresis (dead band) can be set to ON and OFF

[Setting method] → Linear Type

1. Move the stick to the off point you want to shift and touch the [OFF] button. The off points change.
2. Move the stick to the on point you want to shift and touch the [ON] button. The on points change.

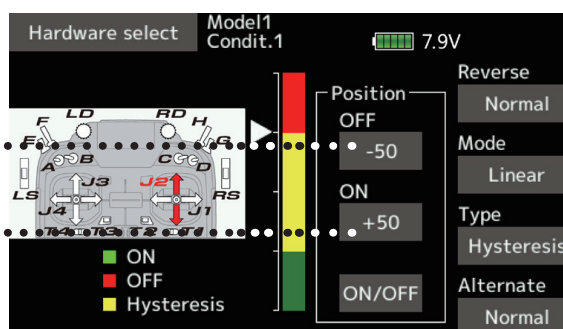

● Symmetry

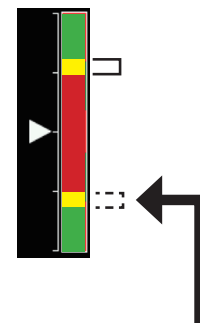

When Upper (Lower) is set, at the same time, Lower (Upper) is also set.

Logic switch (Condition select and DG1, DG2)

The logic switch function lets you turn operation on and off by combining two switches. For instance, the condition is activated when 2 switches are turned on.

Logic mode

AND: When both switches are ON, the condition is ON.

OR: When either switch is ON, the condition is ON.

EX-OR: When the two switches are in different states, the condition is ON.

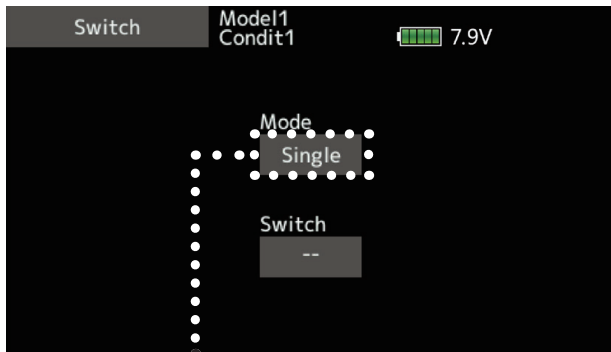

Switch mode selection

1. Tap to the [Mode] "Single" item.
(Logic switch setting screen)

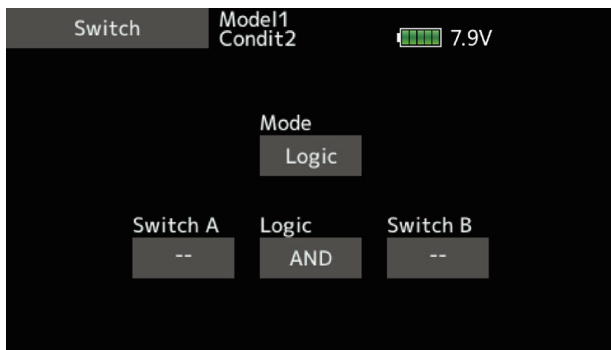

Switch selection

1. Select the switch A and B.

Logic mode selection

1. Tap to the [Logic] item.
2. Select the logic mode.

PC Port

The transmitter can be used as a game controller by connecting it to a computer with a USB cable. (Some games cannot be used.)

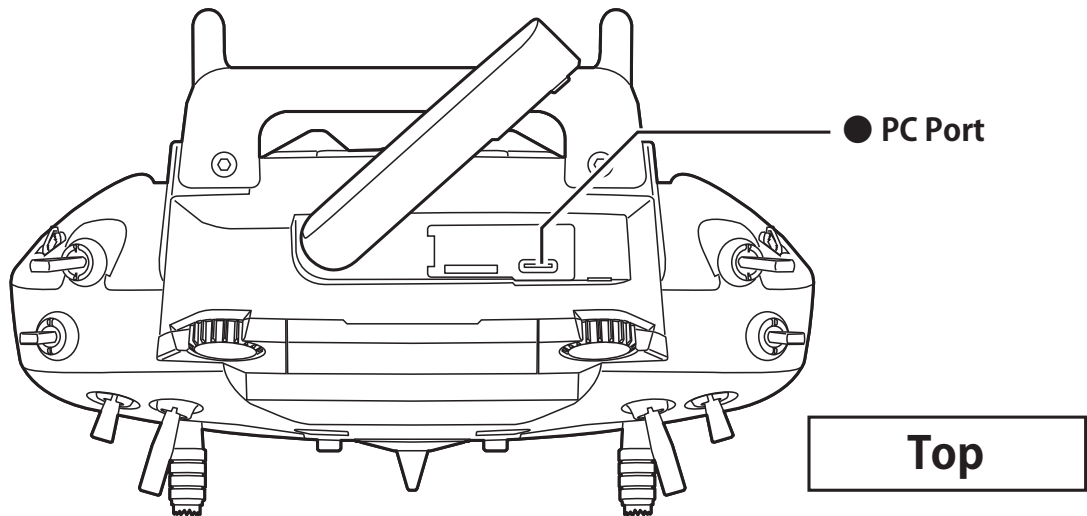

Connection method (for Windows)

1. Connect the T16IZ SUPER PC port to your PC with the USB cable included with the set.
2. When connecting for the first time, setup will start. After the setup is complete, it can be used as a game controller.

*Channels 1 to 8 can be used with a USB connection.

* Operation confirmed simulator software

- RealFlight 8 (Update to the latest version)
- RealFlight 9

[RealFlight setting method]

1. Connect T16IZ SUPER to your PC and start Real Flight.
2. Select "Settings ..." from the "Simulation" menu of RealFlight to open the "Settings" dialog.
3. Set "Deadband Percentage (%)" of "Controller" to 0.

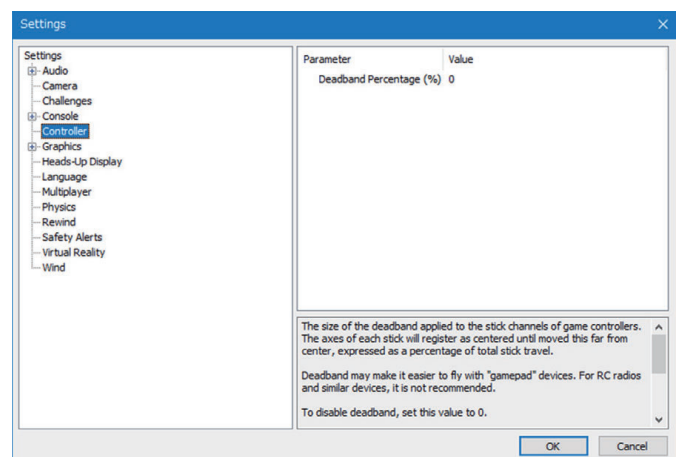

4. Click the [OK] button to close the "Settings" dialog.
5. Select "Select Controller ..." from the "Simulation" menu to open the "Select Controller" dialog.
6. Set "Profile" to "Futaba" and click the [Edit] button.

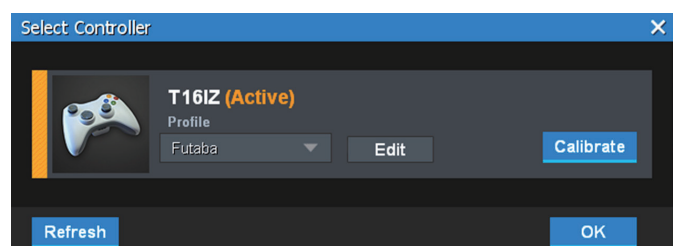

7. If necessary, assign channels and make reverse settings. After setting, click the [Save As ...] button to save the profile.



8. Click the [Close] button to return to the "Select Controller" dialog.

9. Click the [Calibrate] button to calibrate. Set the stick, switch, dial, and lever to be used in the neutral position, and press the [Next] button.

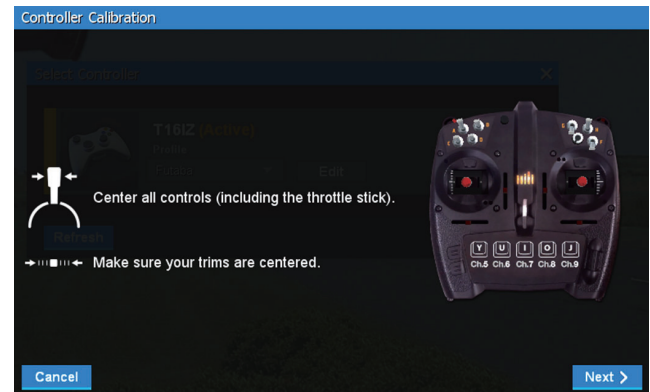

10. Operate the stick, switch, dial, and lever fully left and right or up and down to enter the operating range. After confirming that the correction is complete, press the [Finish] button to return to the "Select Controller" dialog.

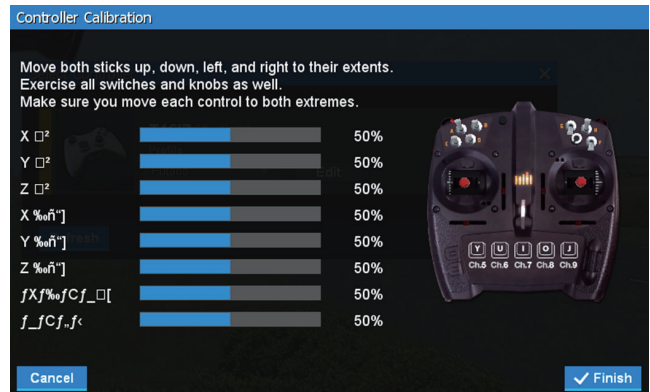

11. Click the [OK] button in the "Select Controller" dialog to close the dialog.

Updating

Your Futaba T16IZ SUPER transmitter programming can be updated easily online. When functions are added or improved, the update file can be downloaded from our website. Copy the update files to the microSD card and then use the following procedure to update the program. Check our web site for the FAQ regarding updating for more information.

Updating procedure

Note: If the battery fully discharges during program updating, updating will fail. When the remaining battery capacity is 50% or less, always recharge the battery before updating.

Note: The model data in the transmitter can be used unchanged after updating, but to be safe, back up the model data before updating.

1. Download the zip file of the update data from our website.

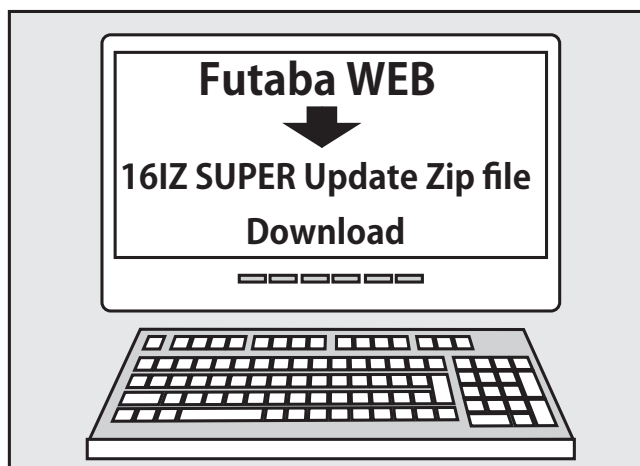

2. Extract the zip file on your computer.
3. The "FUTABA" folder will be created on your computer.
4. Copy the "FUTABA" folder into your microSD card.

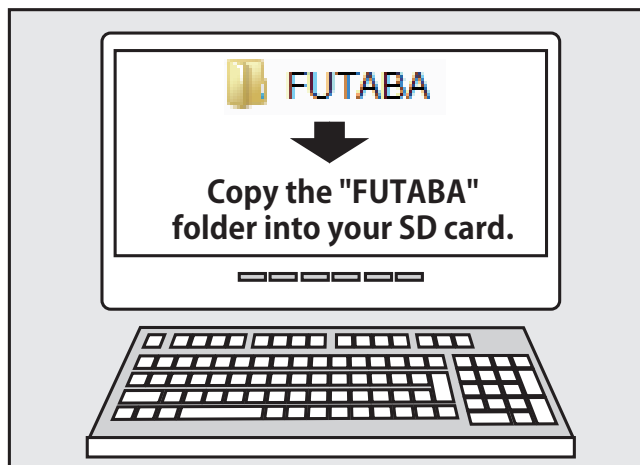

Note: If the microSD card has already had "another FUTABA" folder before you make a copy, the "FUTABA" folder is OVERWRITTEN.

5. Insert the microSD card with "FUTABA" folder that contained the update software into the SD card slot on your T16IZ SUPER radio transmitter.

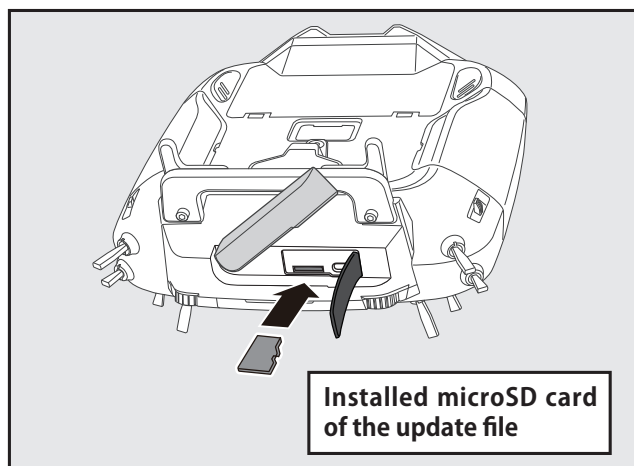

6. Turn on the transmitter power while pressing down the "HOME/EXIT" button. The update screen appears on the LCD display of your T16IZ SUPER and the software update is started.

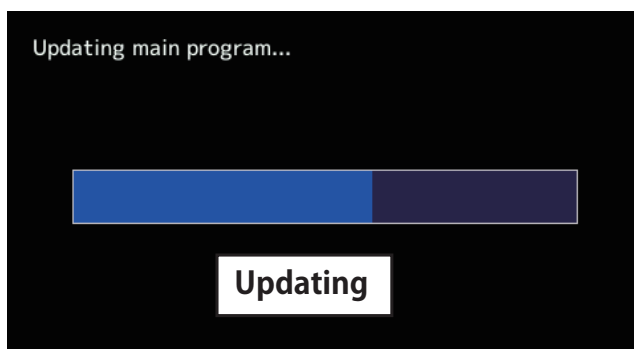
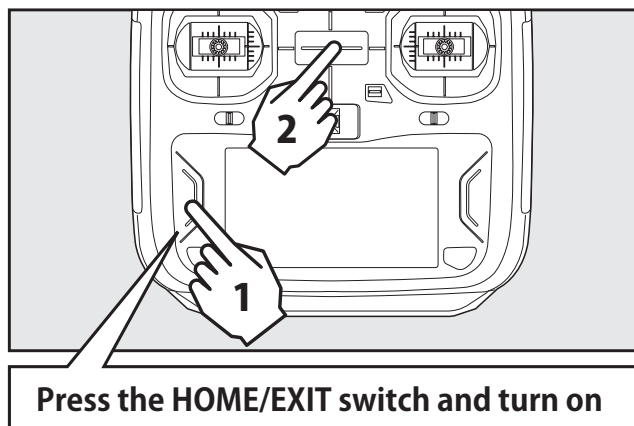

7. When the software update is completed, "Completed" message is shown on the LCD display of your T16IZ SUPER. (Show below picture.)

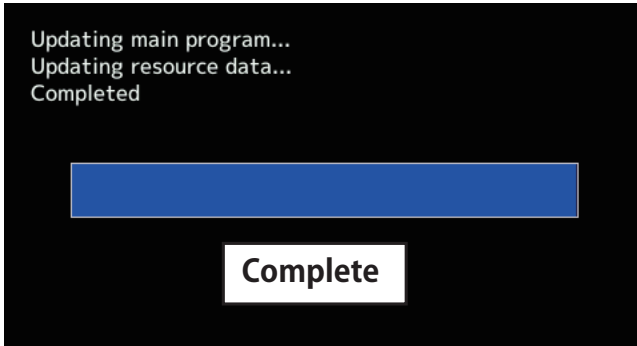

8. Turn off the power switch of your T16IZ SUPER and remove the microSD card from the card slot.

Possible Problems

When one of the error messages shown below appears on the LCD screen your T16IZ SUPER, the software update will not be completed.

"Low battery."

Software update is postponed because of low battery. Retry the software update after the battery is recharged.

"Update file not found."

The T16IZ SUPER cannot find the update file on the microSD card. Check to be sure all the update files have been copied onto the microSD card.

"Broken file."

The T16IZ SUPER detects the update file error. The update file may be broken or for another transmitter.

"Write error."

The software update procedure is stopped for an unknown reason. Contact your local service center when this error message appears on the LCD screen of your T16IZ SUPER.



Don't absolutely remove the battery and the microSD card from the transmitter during the update.

There is a possibility that the transmitter will be damaged.

Recovering a failed update

If you failed to update for any reason, it may transmitter will not start.

In that case, please update again transmitter in the following procedure.

1. Detach the battery from the transmitter.
2. Insert the microSD card that contained the update files to the transmitter.
3. Attach the battery to the transmitter while pressing down the "HOME/EXIT" button.
4. The update will start.

Even after the above steps, if the transmitter fails to update or does not start, please have it serviced.

T14SG/FX-22/T12K → T16IZ SUPER MODEL DATA CONVERSION

The model data (only latest version) of T14SG/FX-22/T12K can be copied to T16IZ SUPER.

- * microSD card is required.
- * The model data of T16IZ SUPER cannot be copied to T14SG/FX-22/T12K.
- * Use an SD card conversion adapter (not included) to insert a microSD card into the T14SG/FX-22/T12K.

[Model data conversion method]

1. Attach a microSD card that contains model data of T14SG/FX-22/T12K to the SD slot of a T16IZ SUPER.
2. Turn on the power switch, and the Data Converter should run.

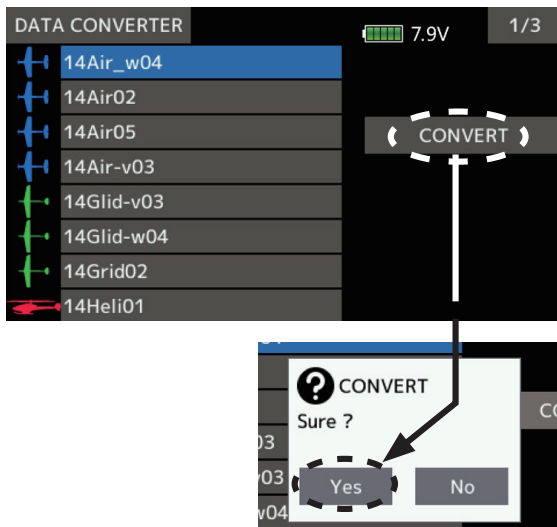

3. The converter shows a list of model data in the card. Select a model data that you want to convert and push "CONVERT" → "Yes" key, and the converter should begin converting data.
4. If the convert succeeds, the converter will show the following message. The converted data are copied to the internal memory of the T16IZ SUPER. Hence, if the T16IZ SUPER does not have available space in its internal memory, converts must fail.

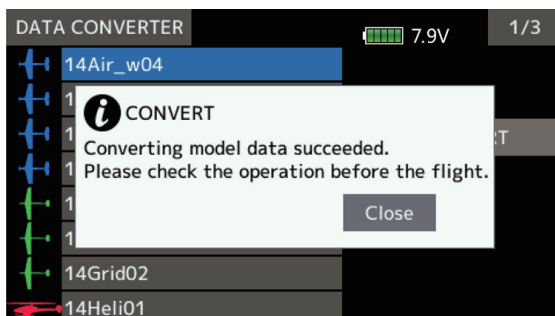

5. The converter can accept model data made by T14SG/FX-22/T12K with the latest software only. If you try to convert model data made by old version software, the converter must fail to convert and show the following error message. If this message is shown, do the following procedure to update the model data in order to avoid this limitation.

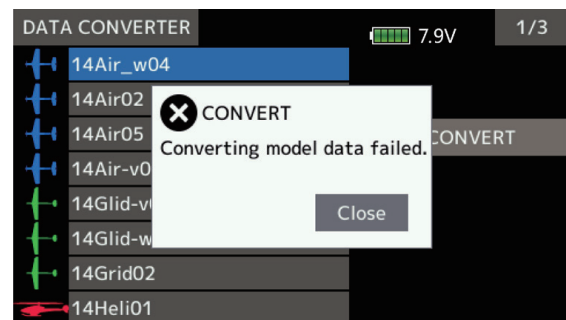

- (a) First, update a T14SG/FX-22/T12K to the latest software.
- (b) Load the model data which failed to convert into the T14SG/FX-22/T12K with the latest software, and the model data should be updated to the latest format.
- (c) Save the updated model data to a microSD card.
- (d) Retry to convert the updated model data on a T16IZ SUPER.

* When microSD card cannot be recognized, it may be able to be used if it reformats by SD formatter offered from SD Association.

SD formatter is downloadable from SD Association

<https://www.sdcard.org/>

⚠ CAUTION

❗ After finishing data copy, be sure to perform a complete check of operation with the model to be used.

❗ Check well all the directions of operation and all the operation switches.

This product uses the following open source software.

■ Google Noto Fonts

This Font Software is licensed under the SIL Open Font License, Version 1.1. This license is copied below, and is also available with a FAQ at: <http://scripts.sil.org/OFL>

SIL OPEN FONT LICENSE Version 1.1 - 26 February 2007

PREAMBLE

The goals of the Open Font License (OFL) are to stimulate worldwide development of collaborative font projects, to support the font creation efforts of academic and linguistic communities, and to provide a free and open framework in which fonts may be shared and improved in partnership with others. The OFL allows the licensed fonts to be used, studied, modified and redistributed freely as long as they are not sold by themselves. The fonts, including any derivative works, can be bundled, embedded, redistributed and/or sold with any software provided that any reserved names are not used by derivative works. The fonts and derivatives, however, cannot be released under any other type of license. The requirement for fonts to remain under this license does not apply to any document created using the fonts or their derivatives.

DEFINITIONS

"Font Software" refers to the set of files released by the Copyright Holder(s) under this license and clearly marked as such. This may include source files, build scripts and documentation. "Reserved Font Name" refers to any names specified as such after the copyright statement(s). "Original Version" refers to the collection of Font Software components as distributed by the Copyright Holder(s). "Modified Version" refers to any derivative made by adding to, deleting, or substituting -- in part or in whole -- any of the components of the Original Version, by changing formats or by porting the Font Software to a new environment. "Author" refers to any designer, engineer, programmer, technical writer or other person who contributed to the Font Software.

PERMISSION & CONDITIONS

Permission is hereby granted, free of charge, to any person obtaining a copy of the Font Software, to use, study, copy, merge, embed, modify, redistribute, and sell modified and unmodified copies of the Font Software, subject to the following conditions:

- 1) Neither the Font Software nor any of its individual components, in Original or Modified Versions, may be sold by itself.
- 2) Original or Modified Versions of the Font Software may be bundled, redistributed and/or sold with any software, provided that each copy contains the above copyright notice and this license. These can be included either as stand-alone text files, human-readable headers or in the appropriate machine-readable metadata fields within text or binary files as long as those fields can be easily viewed by the user.
- 3) No Modified Version of the Font Software may use the Reserved Font Name(s) unless explicit written permission is granted by the corresponding Copyright Holder. This restriction only applies to the primary font name as presented to the users.
- 4) The name(s) of the Copyright Holder(s) or the Author(s) of the Font Software shall not be used to promote, endorse or advertise any Modified Version, except to acknowledge the contribution(s) of the Copyright Holder(s) and the Author(s) or with their explicit written permission.
- 5) The Font Software, modified or unmodified, in part or in whole, must be distributed entirely under this license, and must not be distributed under any other license. The requirement for fonts to remain under this license does not apply to any document created using the Font Software.

TERMINATION

This license becomes null and void if any of the above conditions are not met.

DISCLAIMER

THE FONT SOFTWARE IS PROVIDED "AS IS", WITHOUT WARRANTY OF ANY KIND, EXPRESS OR IMPLIED, INCLUDING BUT NOT LIMITED TO ANY WARRANTIES OF MERCHANTABILITY, FITNESS FOR A PARTICULAR PURPOSE AND NONINFRINGEMENT OF COPYRIGHT, PATENT, TRADEMARK, OR OTHER RIGHT. IN NO EVENT SHALL THE COPYRIGHT HOLDER BE LIABLE FOR ANY CLAIM, DAMAGES OR OTHER LIABILITY, INCLUDING ANY GENERAL, SPECIAL, INDIRECT, INCIDENTAL, OR CONSEQUENTIAL DAMAGES, WHETHER IN AN ACTION OF CONTRACT, TORT OR OTHERWISE, ARISING FROM, OUT OF THE USE OR INABILITY TO USE THE FONT SOFTWARE OR FROM OTHER DEALINGS IN THE FONT SOFTWARE.

FUTABA CORPORATION

Hobby Radio Control Business Center Sales & Marketing Department
1080 Yabutsuka, Chosei-mura, Chosei-gun, Chiba-ken, 299-4395, Japan
TEL: +81-475-32-6051, FAX: +81-475-32-2915

©FUTABA CORPORATION 2023, 01 (1)

T161Z
SUPER

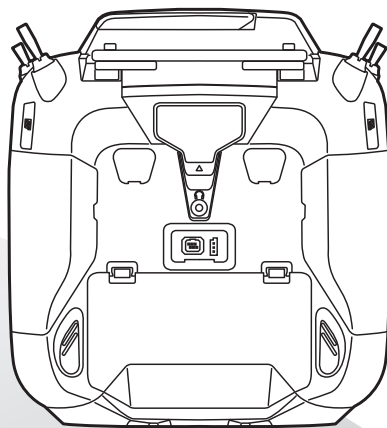

Futaba