

2. Preparing the software update card.

1. Please unzip the zipped file. The following files will be created.

- T12KUpdate.exe
- T12KUpdate.dat
- T12K_UPDATE.dat
- T12K_AP.bin
- T12K_UPLD.bin

2. Insert the "formatted" micro SD card into a card reader in your PC.

3. Please run "T12KUpdate.exe".

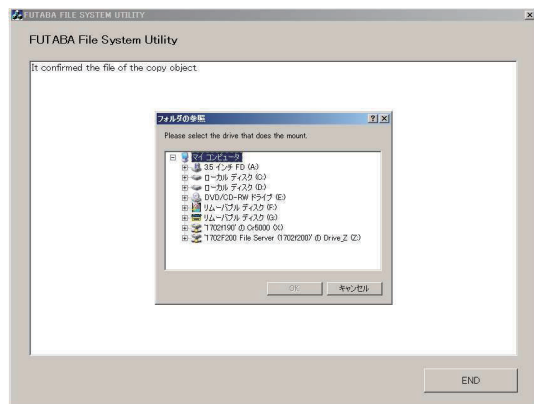

4. Select the drive that your card reader is assigned to in your PC.

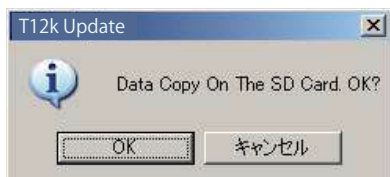

5. After the Update files are copied to the micro SD card, the following screens are displayed. Click the "End" button.

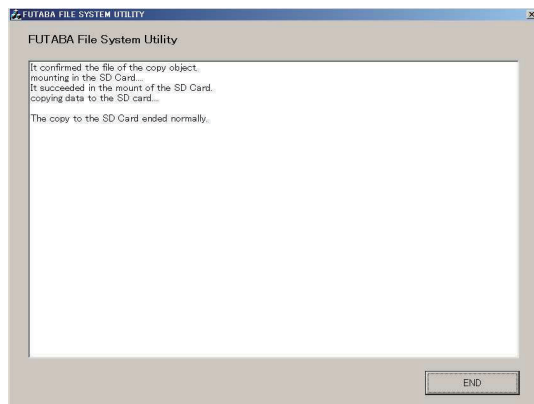

3. Update software of T12K

1. Please insert the micro SD card which includes the update file.
2. Push the HOME/EXIT button.
3. While still holding the HOME/EXIT button, power on the transmitter.

T12K:

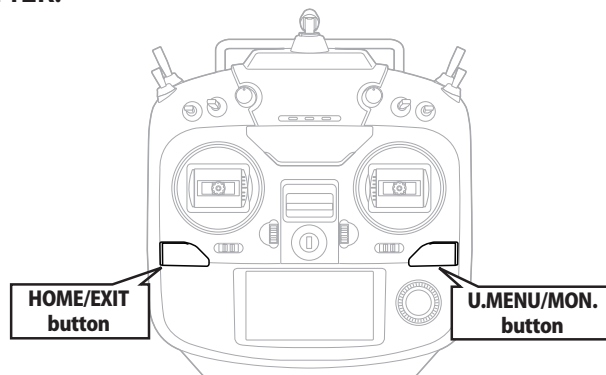

4. After a few seconds, the following screen is displayed.

```
PROGRAM UPDATE
START: PUSH MON. 3SEC
```

5. Push the U.MENU/MON. button for three seconds. The software update will begin.

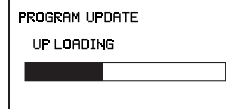

6. When the update is complete, the following screen is displayed. Turn off the power switch.



7. Remove the micro SD card.

```
SYSTEM MENU
TRAINER : START SEL.
DISPLAY : AUTO LOCK
USER NAME : INFO
SOUND : SBUS SERVO
H/W SET :
```

8. Please check the software version at INFO in SYSTEM menu.

```
INFO
PRODUCT 012050002
RF ID 122920001
LANGUAGE ENGLISH
VERSION 
AREA JAPAN
CARD SIZE 8/3266
```

Language table

Choose from these files.

Version No.	Selectable language		
Ver.x.x (No suffix)	English	Japanese	German
Ver.x.x A	English	Dutch	French
Ver.x.x B	English	Spanish	Czech
Ver.x.x C	English	Russian	Italian

T12K INSTALLING SPEECH DATA

There are three language versions, English, German, and Japanese, in speech data. It is possible to install only one language. If you install a second language, it will override the first one that you installed. Speech data is the same as T14SG.

*The telemetry speech and the version of installed speech data can be confirmed on the "TELEM.SET." screen.

*After updates, there is a possibility that a language changes. Readjust a language in that case.

Speech Language table Choose from these files.

Version No.	English	Japanese	German	French
Ver.x.x (No suffix)	<input type="radio"/>	<input type="radio"/>	<input type="radio"/>	—
Ver.x.x A	<input type="radio"/>	—	<input type="radio"/>	<input type="radio"/>
Ver.x.x B	<input type="radio"/>	—	<input type="radio"/>	<input type="radio"/>
Ver.x.x C	<input type="radio"/>	—	<input type="radio"/>	<input type="radio"/>

[Installing procedure]

1. Making of card for installing speech data

1. Please unzip the zipped file. The following files will be created.

English Version

- T14sgInstallSoundEng.exe
- T14sgUpdate.dat
- T14SG_INSTALL_SOUND.dat
- T14sgSpeechEng1.bin
- T14sgSpeechEng2.bin
- T14sgSpeechEng3.bin

German Version

- T14sgInstallSoundEng.exe
- T14sgUpdate.dat
- T14SG_INSTALL_SOUND.dat
- T14sgSpeechGer1.bin
- T14sgSpeechGer2.bin
- T14sgSpeechGer3.bin

Japanese Version

- T14sgInstallSoundEng.exe
- T14sgUpdate.dat
- T14SG_INSTALL_SOUND.dat
- T14sgSpeechJpn1.bin
- T14sgSpeechJpn2.bin
- T14sgSpeechJpn3.bin

2. Install the already formatted SD card into your PC's card reader.

3. Please run "T14sgInstallSound***.exe".

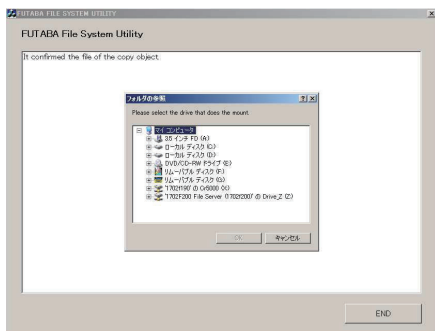

4. Select the drive that your card reader is assigned to in your PC. Click "OK".

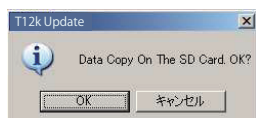

5. After the Update files are copied to the micro SD card, the following screens are displayed. Click the "End" button.

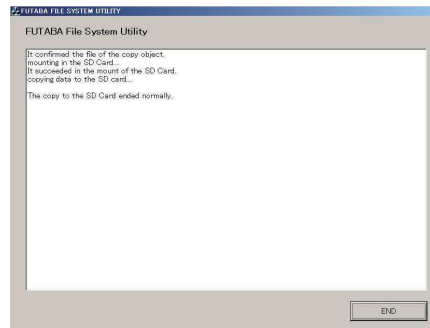

2. Install speech data of T12K

1. Please insert the micro SD card which includes the installing speech data.

2. Push the HOME/EXIT button.

3. Still holding the HOME/EXIT button, power on the transmitter.

4. After a few seconds, the following screen is displayed.

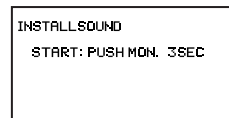

5. Press the U.MENU/MON. button for three seconds. The speech data begins to install.

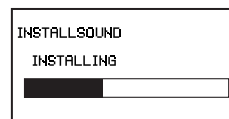

6. After about 16 seconds, uploading reaches the right of the progress bar, and then begins again after a pause.

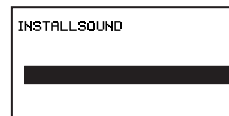

7. The uploading may appear to progress slowly.

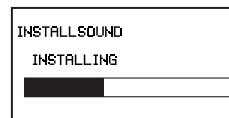

8. The progress bar will again upload. This can take a few minutes. (About. 2 min.)



And, "COMPLETED" is displayed. Please turn off the power.

(Don't turn off the power before COMPLETED is displayed.)

9. Please detach micro SD card.

10. Please check the language at TELEM.SET. menu in LINKAGE menu.

FUTABA CORPORATION

oak kandakajicho 8F 3-4 Kandakajicho, Chiyoda-ku, Tokyo 101-0045, Japan
TEL: +81-3-4316-4820, FAX: +81-3-4316-4823

©FUTABA CORPORATION 2018, 2 (1)

T12K Software Update Changes (Version 4.x)

This software update modifies features found on the T12K. If you have questions about these updated directions, please consult your instruction manual or futabausa.com for further details. Refer to the original manual where applicable but replace the steps indicated below with these instructions.

1. SBUS SERVO S.BUS CH setting

CH setting of **O.S.** Engine's **KS-01** is available. **KS-01** is a device that turns on / off the igniter power of the gasoline engine from the transmitter. Turn on / off with 5ch of the transmitter, but use it when you want to change to another channel.

- ◆ Connect the **KS-01** to the **S.I / F** port with a battery as shown.
- ◆ Select **SBUS SERVO** menu in **SYSTEM** menu.

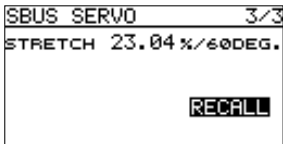

- ◆ Move to page 3/3.
- ◆ Operate **RECALL** button. (**RECALL** is chosen. ⇒ **RTN** is pushed. ⇒ **RTN** is pushed for 1 second.) **CH setting screen** is shown.

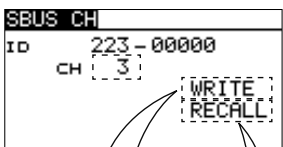

- ◆ Set the **CH** to turn on / off the igniter.
*Setting range: CH1-CH12, DG1, DG2
- ◆ Operate **WRITE** button. (**WRITE** is chosen. ⇒ **RTN** is pushed. ⇒ **RTN** is pushed for 1 second.) The settings are changed.

WRITE operating is writing CH setting to KS-01.

RECALL operation is reading CH setting from KS-01.

- ◆ When the **WRITE** operation is success, the message "**COMPLETED**" is shown. When the **WRITE** operation is failure, the message "**FAILED**" is shown.

Connection

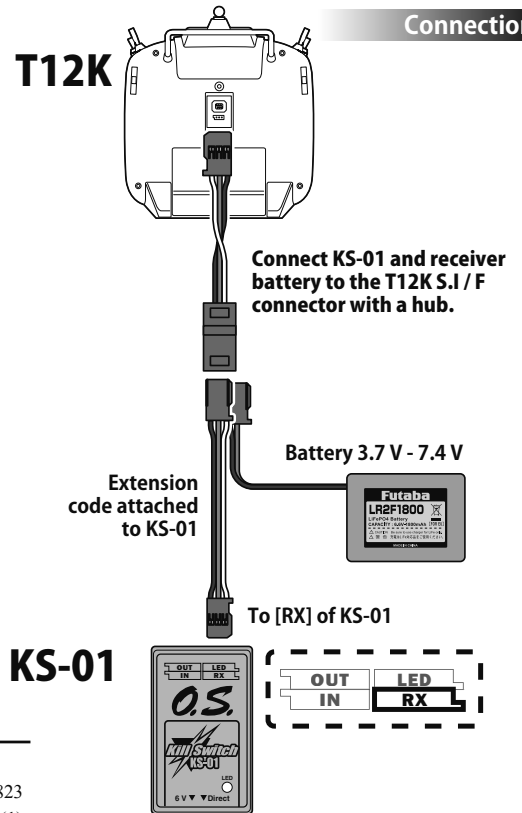

FUTABA CORPORATION

T12K Software Update Changes (Version 3.x)

This software update modifies features found on the T12K. If you have questions about these updated directions, please consult your instruction manual or futabausa.com for further details. Refer to the original manual where applicable but replace the steps indicated below with these instructions.

CRSF protocol for T12K

T12K has been made compatible with CRSF (TBS) protocol.

- *Bidirectional communication function of CRSF is not supported.
- *Making a special cable is necessary to connecting with CRSF Tx module.
- *When using CRSF, the S.BUS servo setting function and [RELOAD] [REGISTER] [RELOCATE] [SET SLOT] functions cannot be used. When setting S.BUS servo and sensor, please set CRSF to OFF.
- *When CRSF is ON, "POWER MODE" screen is not displayed even if you turn on the power with pushing RTN key.
- *When CRSF is ON, it does not output 2.4 GHz RF. (Monitor LED is turned off.)



Caution



Futaba is not responsible for damage sustained by combination with parts other than Futaba Genuine equipment.

◆ Setting to apply CRSF

1. LINKAGE MENU → SYSTEM is opened from the transmitter.

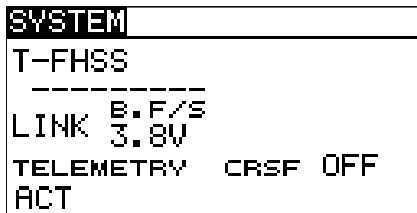

2. Move the cursor to [CRSF] item and push RTN button to switch the data input mode.
3. Select ON by scrolling the push dial. The display blinks.

4. Push RTN button to activate the function and return to the cursor mode. (ON is displayed)

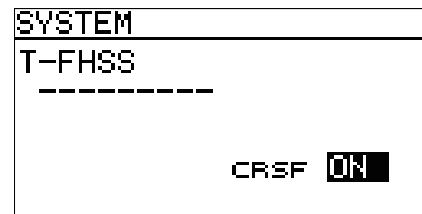
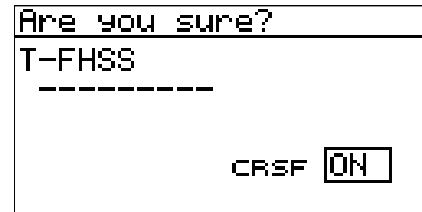

A signal conforming to the CRSF standard is output from the S.BUS setting connector (S.I/F port) of the transmitter.

◆ Warning Screen at CRSF is ON

On the warning screen when CRSF is ON, if you move the cursor to "YES" and press RTN key, CRSF signal is output from S.BUS setting port (S.I/F). If you move the cursor "NO" and press RTN key, the signal for CRSF is not output.

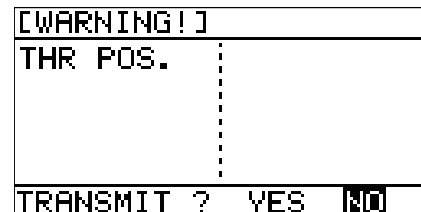

T12K Software Update Changes (Version 2.x)

This software update modifies features found on the T12K. If you have questions about these updated directions, please consult your instruction manual or futabausa.com for further details. Refer to the original manual where applicable but replace the steps indicated below with these instructions.

1. Airspeed Sensor SBS-01TAS

It corresponds to SBS-01TAS(Airspeed Sensor). For details, please refer the instruction manual of SBS-01TAS. For registration of this sensor, the following available slot is required.

The slot which can be registered	1, 2, 3, 4, 5, 6, 7, 8, 9, 10, 11, 12, 13, 14, 15, 16, 17, 18, 19, 20, 21, 22, 23, 24, 25, 26, 27, 28, 29, 30, 31
----------------------------------	-------------------------------------------------------------------------------------------------------------------------

Selection of Sensor

Select "SBS-01TAS"

```

SENSOR 2/3
1 INHIBIT ID 00000
(SBS-01TAS) VARIO-1672
TEMP125 CURR-1678
GPS-1675 ROXXY ESC
VARIO-1712 SPEED-1677
    
```

Alarm setting

<pre> AIRSPEED 1/2 < MIN/MAX > ----- ALERT INH THRESHOLD 300km/h vibes OFF </pre> <p>【Adjustment range】 ↓ THRESHOLD ~ 800km/h</p>	<pre> AIRSPEED 2/2 ALERT INH THRESHOLD 0km/h vibes OFF SPEECH INH </pre> <p>【Adjustment range】 0km/h ~ ↑ THRESHOLD</p>
-------------------------------------------------------------------------------------------------------------------------------------------------------------	--------------------------------------------------------------------------------------------------------------------------------------------

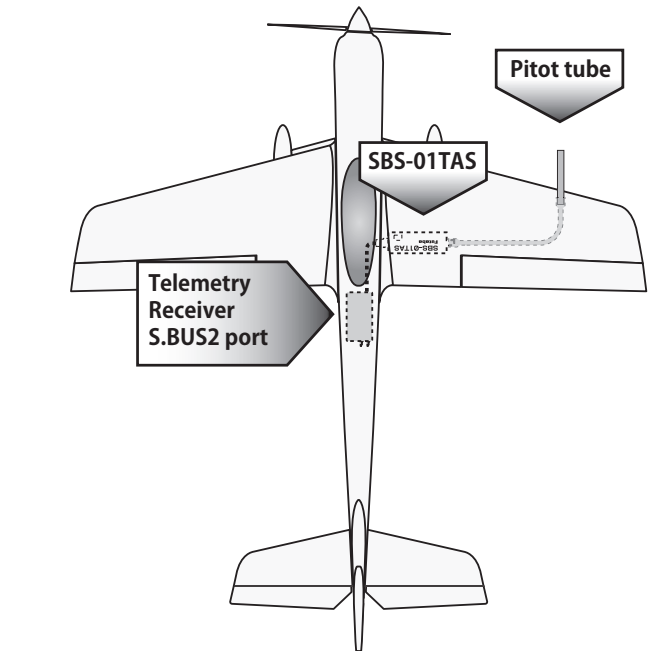

FUTABA CORPORATION

oak kandakajicho 8F 3-4 Kandakajicho, Chiyoda-ku, Tokyo 101-0045, Japan

TEL: +81-3-4316-4820, FAX: +81-3-4316-4823

©FUTABA CORPORATION 2018, 7 (1)