

Futaba®*Flybarless Control Gyro*

CGY750

INSTRUCTION MANUAL

V2.0~

TABLE OF CONTENTS

• Introduction	2
• Warranty and Repair Service (in U.S.A.)	2
• Features	2
• Contents	2
• Precautions	3
• Specifications	3
• Replacement and Optional Items	4
• Gyro Sensor Installation	4
• Connecting the CGY750	5
• TX Set-up	6
• Governor Installation	6
• Governor Fuselage Setting Precautions	6
• First Map	7
• Opening Screen	7
• Home Screen	7
• Warning Display	8
• Setting Menus	8
• S.BUS Basic Setting	9
• Swash Basic Setting	10
• Swash Detail Setting	12
• TX Aileron/Elevator Gyro Gain Set-up	13
• Flight Tuning Setting	14
• Rudder Basic Setting	15
• Governor Basic Setting	16
• Governor Speed Setting	18
• Governor Operation	18
• Recommended Gyro Gain Settings	18
• Adjustments During the Test Flight	18
• Tips for Using the CGY750 Governor with Electric Models	18
• Flight Tune Expert Setting	19
• Rudder Gyro Expert Setting	19
• Governor Expert Setting	20
• Condition Menu	21
• CGY750V2-3D-MAP	22
• CGY750V2-F3C-MAP	24
• F3C Style Tuning Section	26

 : Instructions for gyro functions

 : Instructions for governor functions

Technical updates and additional programming examples can be found at:

www.futaba-rc.com/faq



INTRODUCTION

The Futaba® CGY750 is a combined 3-axis heading hold AVCS gyro and head speed governor in one box. Its cutting-edge MEMS (Micro Electro Mechanical System) sensor design, ultra high-speed processing speed and advanced PID control algorithm put it a quantum leap ahead of all other heading hold gyros in size, weight and performance. The CGY750 has been optimized to work for flybarless helicopters.

WARRANTY & REPAIR SERVICE (IN U.S.A.)

If any difficulties are encountered while setting up or operating your CGY750, please consult the instruction manual first. For further assistance you may also refer to your hobby dealer or contact the Futaba Service Center at the web site, fax or telephone number listed below:

www.futaba-rc.com or www.hobbyservices.com
 Fax (217)-398-7721, Tel (217) 398-0007

If you are unable to resolve the issue, pack the system in its original container with a note enclosed and a thorough, accurate description of the difficulty. Include the following in your note:

- Symptoms (including when the problem occurred)
- System (Transmitter, Receiver, Servos and model numbers)
- Model (Model name)
- Model numbers and quantity
- Your Name, Address and Telephone number

Send the respective items to the authorized Futaba Service Center Address below:

Futaba Service Center
 3002 N Apollo Drive Suite 1
 Champaign, IL 61822

FEATURES

- Combined 3-Axis Gyro and Governor in one box.
- High speed operation and extremely low latencies result in greater stability.
- Low profile, small size and light weight.
- Small size of the gyro and governor controller, 44 x 29 x 12mm, 13 g
- Utilizes a 128 x 36 dots graphical white color OLED (Organic Light Emitting Display), high brightness and contrast even in direct sunlight.
- Settings divided into Basic and Expert menus. The basic setting is for initial setting and Expert setting is for more advanced settings.
- Firmware can be updated from a Windows based personal computer when used with the optional CIU-2 interface.
- S.BUS compatible. Only one connection is necessary between the S.BUS receiver and CGY750 control box for operation.
- **Gyro section**
 - Advanced and adaptive PID control loop is utilized
 - Small and low profile 3-axis gyro sensor. 21 x 21 x 8.5mm, 8g
- **Rudder (yaw) section:**
 - Capable of sensing angular velocity up to +/- 1,200 deg/sec.
 - Compatible with 1520µS Analog (70Hz), 1520µS Digital (280Hz), and 760µS Digital (560Hz) tail rotor servos.
 - Feed Forward Option allows the CGY750 to consider other control functions during operation. This results in more accurate corrections and precise operation.
 - Cutting edge control algorithm provides a consistent pirouette rate, precise operation, and smooth yaw control in any flight condition.

Aileron, Elevator (roll, pitch) section:

- Developed specifically for flybarless helicopters.
- Supports H3-120, H3-140, H3-90, H4-00, and H4-45 swashplate types.

Governor section

- Advanced and adaptive PID control loop is utilized.
- High speed operation and extremely low latencies provide a more consistent and accurate operation.
- Capable of governing head speeds from 700 RPM through 4000 RPM
- Compatible with 1520µS Analog (70Hz) and 1520µS Digital (280Hz) throttle servo types.
- Feed Forward Option allows the CGY750 to consider other control functions during operation. This results in precise governing of the head speed.
- Governor or Revolution Limiter mode selectable.
- Supports gear ratios from 1.00 through 50.00.
- Cutting edge control algorithm provides more consistent RPM governing.
- Revolution sensor is compatible with the GV-1. The CGY750 also supports an optional back plate revolution sensor and brushless phase sensor.

Other functions

- Maximum RPM memory.
- Cumulative engine operation timer.
- Power saving OLED.

CONTENTS

Your CGY750 includes the following components:

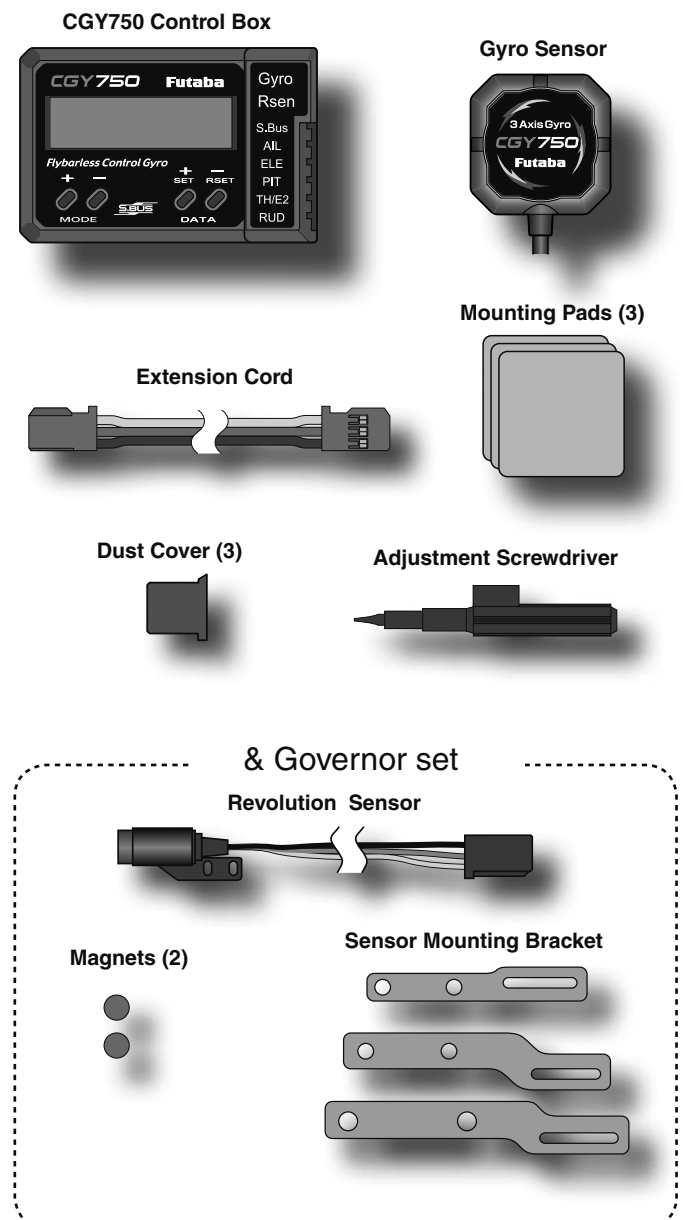

PRECAUTIONS

Meaning of Special Markings

Pay special attention to safety where indicated by the following marks:

⚠ DANGER - Procedures which may lead to dangerous conditions and cause death/serious injury if not carried out properly.

⚠ WARNING - Procedures which may lead to a dangerous condition or cause death or serious injury to the user if not carried out properly or procedures where the probability of superficial injury or physical damage is high.

⚠ CAUTION - Procedures where the possibility of serious injury to the user is small, but there is a danger of injury, or physical damage, if not carried out properly.

⊘ : Prohibited ① : Mandatory

⚠ WARNING

Failure to follow these safety precautions may result in severe injury to yourself and others.

• Read through the entire manual before operating this product.

BEFORE EACH FLIGHT:

① Always check the transmitter and receiver battery voltage to ensure they have enough remaining capacity to complete the flight.

① Always exit programming mode before attempting to fly the model.

① Only use the CGY750 with a 2.4GHz system such as the Futaba FASST™ system, or a PCM system. Use with an FM system is strongly discouraged since interference can cause serious operational problems.

Gyro operating precautions: Gyro

⊘ **The CGY750 requires 5-10 seconds to initialize when the power is turned on. Do not move the helicopter and do not move the tail rotor, aileron and elevator sticks during this initialization or the gyro may not initialize properly. Once the initialization process has been completed the swash servos and tail servo will move several times indicating that the CGY750 is now ready for flight.**

① Verify that the gyros are operating and compensating in the correct direction before each flight. If the compensation direction is incorrect on any axis the model will become uncontrollable after takeoff.

① Verify that the gyro is operating in the desired mode.

① Verify that the gyro mounting pads are in good condition.

① Verify that the gyro wires are not contacting the frame of the helicopter.

① The servo type parameters within the CGY750 must match the type of servo you are using. Incorrect setting may damage the CGY750 or the servos, possibly resulting in a loss of control during flight.

① Always ensure that there is some slack in the gyro cables to help maximize performance. Always use the supplied gyro mounting pads to attach the gyro to the helicopter mechanics. Do not use a strap that encompasses the CGY750 sensor. This may affect the overall performance of the gyro.

① Always allow the gyro to adjust to the surrounding environmental temperature before flight. A large temperature change during use will cause drift and other operational issues.

⊘ The gyro sensor and control box have an electroconductive coating. Do not allow any power leads or other wiring to come into contact with these items.

① If you are switching between Normal Mode and AVCS Mode in flight, please keep in mind that you must have the gyro re-learn the center position after making a trim change within the transmitter. To memorize the new center position simply flip the gain switch on the transmitter three times between Normal Mode and AVCS Mode (Normal→AVCS→Normal→AVCS) within one second. The servo will center indicating that the new center position has been memorized.

① When operating the gyro in AVCS Mode, all compensation and revolution mixing must be disabled and any tail rotor or swash offsets for flight modes must be disabled.

① When the CGY750 is operated in AVCS mode the tail rotor or swashplate servos will not center when tail rotor, aileron or rudder stick is released. This is normal operation for AVCS mode. The servos

may also move to the extent while the model is being carried out to the flight line. Before take off, you must visually center the tail rotor pitch slider and level the swash plate by using the transmitter control sticks. You can also center the servos by moving the tail rotor stick full left, then full right, back to full left and then allow the stick to center within one second; the same method applies for aileron and elevator servos.

⊘ Do not drop the CGY750 sensor onto a hard surface or subject the CGY750 sensor to a strong shock as this may damage the sensor.

① Always use the supplied mounting pads or the Futaba replacement mounting pads available from your local Futaba dealer.

Governor operating precautions: Governor

① When the throttle servo is connected to the CGY750, the battery fail-safe function within the CGY750 must be setup and enabled.

① Throttle fail safe function (transmitter setting): Use the fail safe function for the channel that turns the governor on and off to set the fail safe position to the point at which the governor is turned off. With this setting, when the system enters the fail safe state, the governor will be turned off, and the receiver throttle signal (fail safe position preset) will be output directly.

① When using the condition hold function on the transmitter, always set the throttle servo maximum operating point to less than the point at which the governor is activated. If this is not done the governor may activate while in condition hold.

① While preparing for flight or starting the engine, always ensure the throttle remains below the governor activation point and do not select any flight modes that may activate the governor.

① If you prefer to activate the governor while the model is still on the ground, always ensure that you have at least -5 degrees of pitch in the model before activating the governor. This negative pitch is necessary to prevent an unexpected lift off as the governor activates and the head speed increases to the desired RPM.

① Periodically check the RPM sensor output to ensure proper governor operation. Due to the high level of vibration and centrifugal forces the magnet may come loose or the sensor alignment may change. Every 10th flight verify that the magnet and sensor are properly mounted.

SPECIFICATIONS

Width (Controller): 1.14in [29mm]

(Gyro sensor): 0.83in [21mm]

(Revolution sensor): 0.30in [7.5mm]

Length (Controller): 1.73in [44mm]

(Gyro sensor): 0.83in [21mm]

(Revolution sensor): 0.63in [16mm]

Height (Controller): 0.47in [12mm]

(Gyro sensor): 0.33in [8.5mm]

(Revolution sensor): 0.39in [10mm]

Weight (Controller): 0.459oz [13g]

(Gyro sensor): 0.282oz [8g]

(Revolution sensor): 0.141oz [4g]

Operating Voltage: 3.8V to 8.4V DC*

Current Drain: 70mA

Selectable Servo Frame: 70Hz, 280Hz and 560Hz
(Rudder Gyro only) Rate

Center Pulse Width: 1520µs (70Hz & 280Hz)

760µs (560Hz)

Governor Resolution: 0.1Hz (6rpm)

(Engine RPM)

RPM Accuracy: 1%

Head Speed Range: 700-4,000rpm

Operating Temperature: 14°F to 113°F
(-10°C to +45°C)

Control System: Digital advanced control

Sensor: Micro Electromechanical

Systems (MEMS) Gyro

Hall effect sensor

Angular Velocity Range: ±1,200 Degrees Per
Second (Gyro)

* The operating voltage shown only applies to the CGY750. Always verify that your receiver, servos, tail rotor servo, switch and any other electronic components used in your installation are capable of operating at the voltage you plan to use.

Futaba PC Interface CIU-2: FUTM0951

Extension 200 mm:
 Extension 350 mm:
 Extension 55 mm:
 Extension 80 mm:
 Extension 130 mm:

Mounting Pad:
 1x22x22 mm (10)

⚠ WARNING

❶ **Newer high end servos and other radio equipment are capable of placing large demands on the power systems in use today. When using a regulator you must ensure that the regulator is capable of supplying the current demands of the equipment you have selected. In addition to this make sure the wiring and switch you have selected are capable of handling high current draws.**

- The servo current draw can be up to 50% higher on a flybarless helicopter. Always ensure your receiver battery is fully charged before each flight.

❶ **Even though the CGY750 is a high performance gyro and governor, it will be necessary to ensure that the helicopter mechanics are also in optimum operating condition. Please use the guidelines below and address all issues before installing and flying the CGY750.**

- The CGY750 must be used with a rigid tail rotor drive system. Any modern torque tube or belt drive system should be adequate. Do not attempt to fly the CGY750 using a wire driven tail rotor system.
- Always ensure the drive gears, torque tube, pulleys, belt, bearings and shafts are in proper working condition. If any of these items are damaged or worn they must be replaced.
- The linkage rod, tail rotor bell crank, pitch slider and tail rotor grips must operate without friction to obtain the best performance from the CGY750. Binding in the tail rotor control linkage will decrease the performance of the CGY750 gyro and this may also shorten the servo lifespan. Please take the time now to ensure the tail rotor system on your helicopter is working correctly and without friction or binding.
- Vibration will affect the CGY750's overall performance. All rotating components on the helicopter should be balanced to minimize vibrations in flight. Ensure that your engine or electric motor is running smoothly and that all vibrations have been addressed before installing and test flying the CGY750.

Gyro sensor replacement:

- Each CGY750 gyro control box is calibrated specifically for the gyro sensor included. Do not attempt to use another CGY750 sensor with the control box as performance will suffer due to being out of calibration. The calibration process must be completed by an authorized service center.

If your sensor needs replacement, please send the complete unit to your region's support center for repair.

The gyro sensor should be mounted on a rigid platform, at least 6in [152mm] away from a Nitro Engine. It is not necessary to mount the gyro near the main shaft of the helicopter but it is very important that the mounting area chosen is rigid. Please refer to your helicopter manufacturer's instructions for recommended mounting locations.

Test fit the gyro sensor, ensuring that the sensor is in alignment with the helicopter on the roll and pitch axis. The cable from the gyro sensor must exit toward the front or the rear of the helicopter since this is the pitch axis. Any misalignment will cause a loss of performance.

Once you are certain everything is properly aligned and that the sensor lead can be routed to the gyro, go ahead and mount the gyro sensor to the helicopter using one of the supplied gyro pads. Route the gyro sensor lead to the CGY750 control box and plug the lead into the gyro sensor port. Verify that the connector is firmly locked in place.

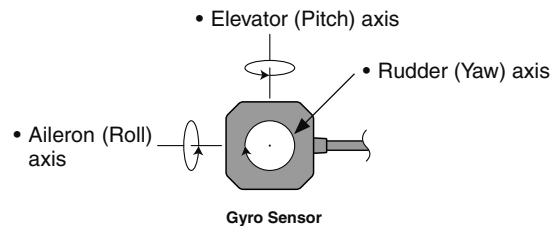

Important: The CGY750 gyro sensor must be mounted so that the roll and pitch sensing axis are in alignment with the helicopter. Any misalignments over 1/2 of a degree will cause a loss in performance. Please take extra care in this step to ensure the optimum flight performance.

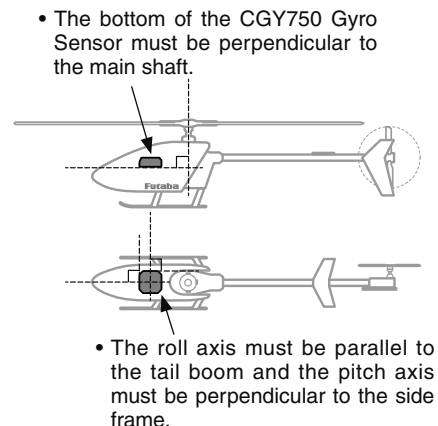

TROUBLESHOOTING

If any issues are noted during flight (such as drifting, inconsistent hold or inconsistent control rates) then please review the following troubleshooting recommendations.

1. Always verify that the tail rotor and swash plate mechanisms operate, and that the drive system is in proper working order.
2. Electromagnetic interference could be causing the problem. If you feel everything is set up correctly and that the helicopter is vibration free, then consider moving the gyro sensor to a new location away from servos, ESC and drive motors.
3. Vibrations will decrease the performance of all gyro systems. Even though the CGY750 gyro sensor is the most vibration resistant gyro sensor available, eliminating vibrations will always improve performance. The CGY750 gyro sensor performs best when the sensor is mounted rigidly to the airframe. This is mainly due to the sensing of all 3 axes. It is highly recommended to avoid using soft foam pads as this may allow the gyro to bounce around on the roll and pitch axis, causing instabilities and possible loss of control during flight.

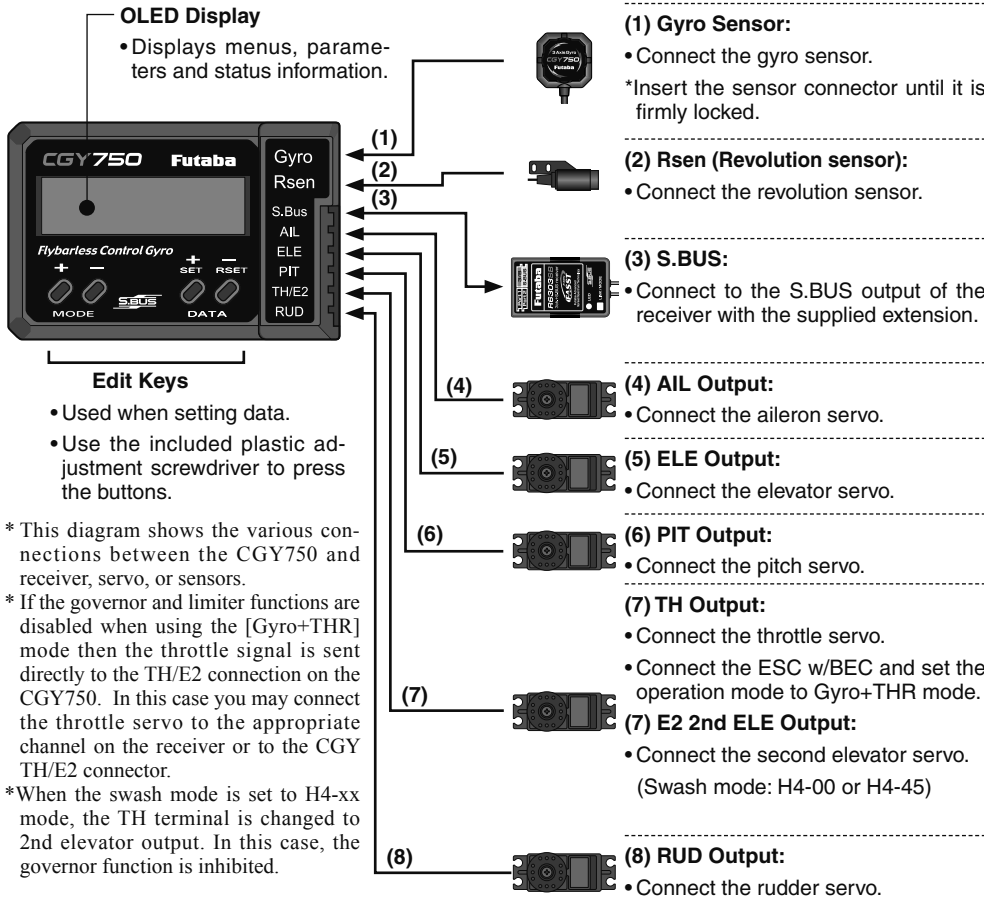

* This diagram shows the various connections between the CGY750 and receiver, servo, or sensors.
* If the governor and limiter functions are disabled when using the [Gyro+THR] mode then the throttle signal is sent directly to the TH/E2 connection on the CGY750. In this case you may connect the throttle servo to the appropriate channel on the receiver or to the CGY TH/E2 connector.
* When the swash mode is set to H4-xx mode, the TH terminal is changed to 2nd elevator output. In this case, the governor function is inhibited.

Installing the Sensor Connector

⚠ WARNING
❗ You will feel resistance at two points when inserting the connector. Make sure that you plug in the connector completely, or connection problems may result.

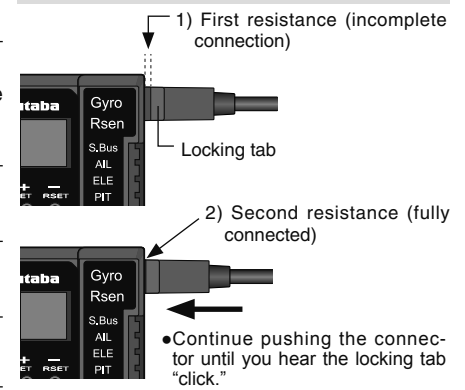

Your transmitter should be reset to the default settings and the swash plate type selected with the transmitter should be set to **Normal (H-1) or single servo mode**. All CCPM mixing is set up and handled with the CGY750, and the transmitter functions should not be used. Before starting helicopter set-up, be sure that all dual rates, pitch curve, and endpoint values are set to 100/100.

Swash Type H-1

Connection to the receiver, servos and sensors

The CGY750 requires an S.BUS receiver or the optional PWM Receiver to S.BUS adapter available separately.

Using the supplied extension connect the S.BUS receiver port (or from the S.BUS PWM adapter) to the CGY750 S.BUS port. Install your receiver battery, regulator, switch and any other necessary electronics now. Connect the power lead of your switch / regulator to the battery connector on the receiver.

Plug the cyclic servos (AIL-[Aileron], ELE-[Elevator], PIT [Pitch], RUD [Tail Rotor] and if using the H4xx swash plate type TH/E2-[Elevator 2]) into the appropriate port on the CGY750.

Determine the best location to place the receiver and CGY750 control box. Mount the receiver and the CGY750 control box to the helicopter mechanics using vibration adsorbing self adhesive foam pads. The CGY750 gyro sensor will be installed in a later step.

Using wire mounts, wiring fixtures molded into the helicopter, or hook and loop material, route the servo leads and extensions. Make sure the wires are not rubbing against metal or carbon fiber which may damage the wires.

S.BUS channel setting

Since the S.BUS protocol uses a single wire to transmit all channel information to the CGY750 it is necessary to assign each channel number (1 through 16) a function (such as aileron, pitch, collective, gain, ail gain, ele gain, rpm, gv on/off) within the CGY750 control box. The default CGY750 S.BUS channel assignments should work properly with most Futaba transmitters. If you experience any problems please refer to the S.BUS section of the manual to set/verify each channel number for each function.

❑ If your transmitter does not offer enough channels to operate all of the CGY750's functions, it is possible to operate the CGY750 without the GV On/Off, Ail Gain, and Ele Gain channels connected. When any these functions are not used, it is necessary to set the channel number to [INH] within the CGY750's S.BUS menu to disable the function and to use the setting value inside the CGY750 menu instead.

When the GV On/Off channel is not used, the governor on/off control is handled by the [Stick Switch] function.

When the remote Ail or Ele Gain channels are not used, the operating mode (NOR/AVCS) and gain value can be set in the appropriate AIL / ELE Basic menu option by using the Data +/- keys when the function is displayed.

Using the CGY750 with a electric helicopter

⚠ DANGER
❗ It is necessary to remove the pinion gear from the electric motor or disconnect the motor from the ESC before powering the model up for setup or bench testing. Electric motors are extremely powerful and capable of delivering the power instantly, causing injury to yourself, others, or the surroundings.

If the CGY750 is being installed into an electric helicopter and the ESC's own internal governor is to be used, you may want to consider connecting the ESC to the [TH/E2] (throttle / elevator 2) output of the CGY750. Before doing this you must remove the pinion gear from the electric motor or disconnect the motor from the ESC before powering the model up the first time. Once the model has been powered up, navigate to the gyro mode function and set it to [GYRO+THR]. This sets the CGY750 to act as a gyro and throttle output. The CGY750 will simply pass the throttle signal from the receiver through to the TH/E2 port on the CGY750.

Once your ESC is connected to the CGY750, you must complete all necessary transmitter setup (ATV / EPA / REV / ETC) per your ESC instructions. Please refer to the end of this manual for further suggestions for the use of the CGY750's governor with electric powered models.

Condition selection

Condition selection incorporates two adjustable values for a given parameter (displayed c1/c2). This is dictated by the digital channel number "1" within the Function Menu of your transmitter (DG1). Assigning DG1 to a switch or flight mode allows the use of two separate values for the condition selectable parameters.

Rotor Head Gyro Gain "RotHd.Gn"

In the SBUS menu assigning "RotHd.GN" to a channel will allow the Rotor head gain to be adjusted via the TX. If you are using a 6CH or less TX, setting "RotHd.Gn" to "INH" will then default the gain to "BaseGain" in the Flight Tuning menu. Suggested setting and default is CH9.

Tail Rotor Gain "RGn"

In the SBUS menu assigning "RGn" to a free TX channel will allow for the tail rotor gain to be adjusted via the TX. Suggested setting and default is CH5.

NOTE - Before starting helicopter set-up, be sure that all dual rates, pitch curve, and endpoint values are set to 100/100.

- If the cooling fan is unbalanced and vibrates, etc., balance it by mounting the spare magnet to the opposite side of the cooling fan in the opposite polarity (so that it does not output a signal).

Sensor mounting

The sensor mounting method depends on the helicopter and engine.

- Mount the sensor to the sensor stay. (Temporary assembly)
- Drill a hole in the fan cover at the part corresponding to the sensor so that the distance between the sensor and magnet can be made 1 to 2mm.
- Tighten the sensor stay together with the engine mounting flange. (Temporary assembly)
- Select the mounting method so that the sensor does not touch the frame, or other parts of the helicopter. Temporarily mount the sensor and select the magnet mounting position.
- Install the sensor to the sensor stay using the accessory screws and washers.
- Tighten the sensor stay together with the engine using the engine mount screw.

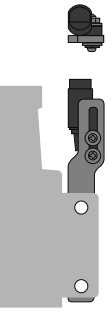

Sensor adjustment

- Adjust the sensor position to obtain a sensor output of at least 60% in the "Revolution sensor testing" menu within the "Governor Basic Setting".

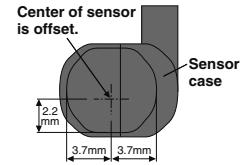
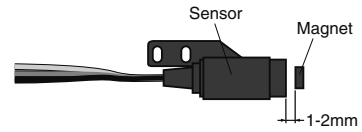

- The center of the sensor is different from the center of the sensor case so be careful when mounting the sensor.
If the display is less than 60% when the magnet is directly below the sensor, bring the sensor closer to the magnet so that the 60% or more is displayed. The magnet and sensor gap criteria is approximately 1 to 2mm. If a sensor output is not obtained even when the sensor is brought close to the magnet, the magnet and sensor center positions may have changed.
- Complete assembly of the sensor by securely tightening the screws that were temporarily tightened.
- Recheck the sensor output.

GOVERNOR INSTALLATION

Governor

Modify the cooling fan and install the accessory magnet and attach the magnetic sensor to the engine at the position shown below. Balance the cooling fan as needed following magnet installation.

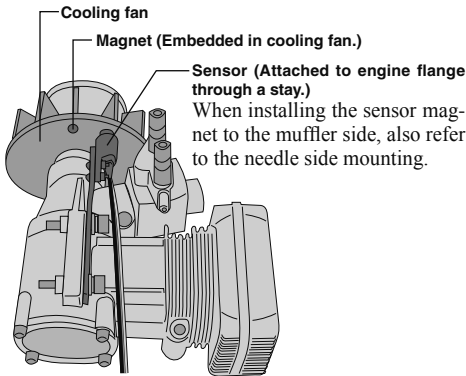

Magnet operating side check

- Bring the magnet near the end of the sensor and check the operating side.

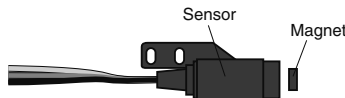

This is the side at which the displayed value increases in the "Revolution sensor testing" menu within the "Governor Basic Setting" section earlier in this manual. Install the magnet with this side facing the sensor. Mark this side of the magnet with a felt tip pen.

Cooling fan modification

- Drill a hole in the fan at the magnet mounting position. Make the hole about 4.1mm in diameter and 1.5 to 1.7mm deep.
- Embed the magnet in this hole in the direction in which an output is obtained. Use epoxy adhesive that cures in 30 minutes or longer. Do not use epoxies that contain metal such as JB Weld.

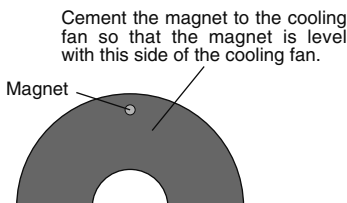

GOVERNOR FUSELAGE SETTING PRECAUTIONS

Governor

Throttle servo linkage precautions

To effectively use the governor, observe the following precautions when connecting the servo linkage.

- Make the servo operating range as wide as possible. Make the throw of the transmitter EPA (ATV) function and AFR function as close as possible to 100%.
- Fly with the governor turned OFF and adjust the needle so that the engine smoothly reacts to movement of the transmitter stick.
If there is a point at which the reaction of the engine is considerably different due to a too rich or too lean mixture, the governor may not operate to its maximum potential.

Fuselage vibration countermeasures

If the helicopter frame is weak, or the engine mount is deformed or not installed properly, the vibrations applied by the engine will increase. Engine vibrations will lead to unstable speed and prevent the governor from providing maximum performance. Therefore, make sure that the engine is vibration free and that the carburetor provides linear throttle control because the governor cannot correct engine problems.

Use of a tuned silencer

The use of a tuned pipe type silencer may cause the engine throttle response to be substantially different from that of a normal muffler. Adjust the needle (and pipe length) so that engine speed changes are proportional to the throttle opening. The governor will not perform satisfactorily with a muffler or a pipe that does not allow the carburetion to be linear.

FIRST MAP

The figure shows the first layer of the editing sequence.

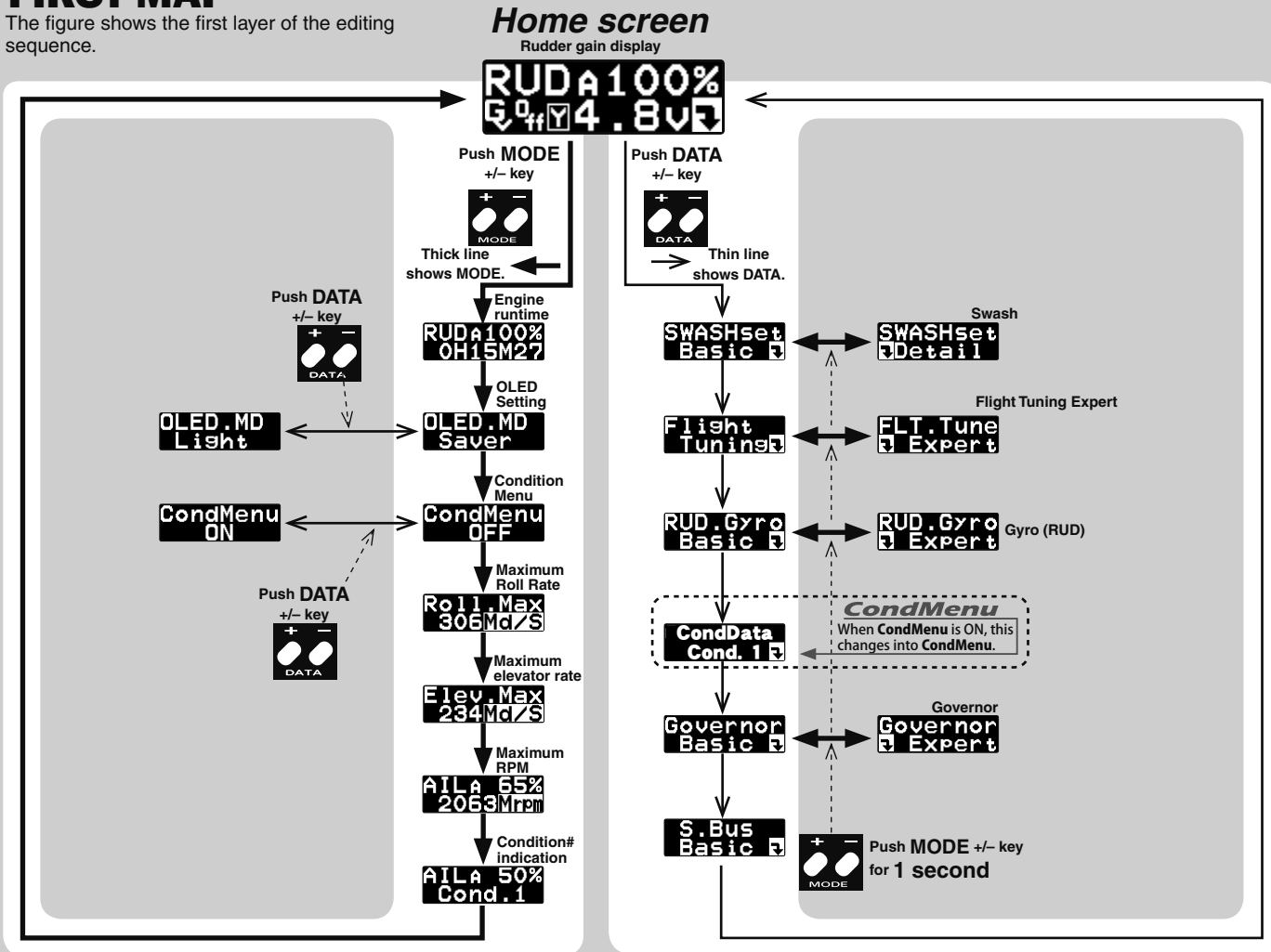

OPENING SCREEN

Verify that all of the connections are correct between the CGY750, receiver, and power supply. If your helicopter is using an electric motor for propulsion, remove the pinion gear now for safety.

If this is the first time the helicopter has been powered up, remove the servo arms and linkages to prevent damaging the servos if any binding is present. Power up the transmitter and allow it to initialize. Turn the receiver on or connect the flight battery and allow the helicopter to remain motionless while the CGY750 initializes.

The display will first show the ID number of your CGY750 and the Firmware Version.

ID:10000
Ver:2.00

After the CGY750 has powered up the screen will change to show an animation of a helicopter performing a stationary flip. This indicates that the initialization process is taking place. The helicopter must remain perfectly still so the controller can determine the gyro's center position for each axis.



Once the initialization process has been completed the Home Screen will be displayed and the cyclic + tail rotor servos will move several times in quick succession.

If the CGY750 is set to the [Gyro+THR] mode or if the H4-xx swash plate type has been selected then the governor will be disabled and the screen will look like (d) below instead. The display will cycle through and show the current AIL, ELE and RUD gains.

Home SCREEN

Initial Home screen

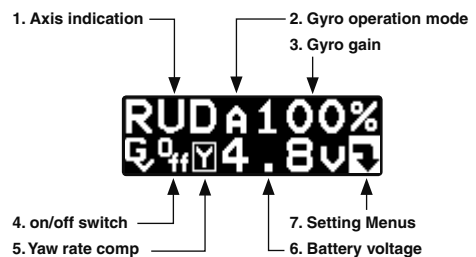

1. Axis indicator Gyro

The axis indicator will cycle every two seconds and show the axis (AIL, ELE or RUD) and their respective current gain values.

2. Gyro operation mode Gyro

The display indicates either [A] for AVCS or [N] for Normal operating modes. If the [A] is shown in inverted colors then the rudder neutral is offset and re-learning the center position should be completed immediately.



When using the AVCS operating mode, the servos will not re-center when the control stick is released. If you need to center the servo, you can move the appropriate control stick to its full extent (left & right or up & down) twice and allow the control stick to return to center within a one second period of time, and the servo(s) for that axis will return to center position.

For example if you move the tail rotor stick full left, full right, full left, full right and allow it to come back to center within one second, then the display will change to show [-----], and the tail rotor servo will center.

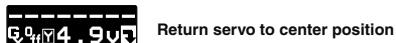

3. Gyro gain Gyro

This indicates the current gyro gain for the axis noted in the Axis Indicator position.

4. Operating condition Governor

This indicates whether the governor is [ON] or [OFF].

5. Battery voltage

This indicates the battery voltage. The display will change to show [LOW BAT] once the voltage has fallen below the Battery fail safe voltage setting (BFS).

6. Setting Menus

Pushing this button will exit the normal operating mode and enter the settings menu mode.



RPM display Governor

The battery voltage display automatically changes to the engine RPM display once the engine is running and returns to battery voltage display once the engine has stopped running. The RPM display can be either the head speed or the engine speed depending on the setting in the revolution display mode setting found in the governor Expert menu.

Home screen options

When the home screen is shown the mode [+] and [-] keys can be used to cycle the bottom line through the following items; Battery voltage, Max RPM, Engine runtime, OLED display options, Operating Mode, Roll rate maximum display, and Elevator rate maximum display.

1. Engine runtime Governor



From the home screen press the mode [+] key twice to show the engine runtime display. The time shown is how long the engine has been running. This is a cumulative timer and the value is maintained in memory. To reset the timer simply press the data [+] or [-] key for more than one second and the timer will reset back to 0.

2. OLED display options [default: Saver]



When the [Saver] option is selected, the display will dim after 60 seconds of inactivity. Once a button is pressed on the CGY750 controller box, the OLED will switch back to full brightness. The [Saver] option helps to conserve power and extend the life of the display. When the [Light] option is selected the display will remain at full brightness at all times.

3. Condition menu [default: OFF]



2 conditions can be established per parameter by assigning CH “DG1” to a switch or flight mode. When the condition menu is turned on, [CondMenu] appears in the main list of menus.

It becomes possible to have two separate value settings for the parameters listed in the condition menu.

The functions included in [CondMenu] disappears from the usual menu.

4. Roll rate maximum display Gyro



This screen displays the maximum roll rate recorded during flight. This value is reset back to 0 when the CGY750 is powered up.

5. Elevator rate maximum display Gyro



This screen displays the maximum elevator rate recorded during flight. This value is reset back to 0 when the CGY750 is powered up.

6. Maximum RPM Governor



From the home screen press the mode [+] button once to show maximum recorded RPM [Mrpm]. The [Mrpm] value is maintained until you clear it by pressing the data [+] or [-] key for at least one second. This function allows you to check for over speeding during flight.

7. Condition



Current condition# is indicated.

WARNING DISPLAY

Governor warning display Governor



The warning symbol is displayed when the governor is activated during power up. Immediately switch to a condition that has the governor disabled, and the symbol will disappear. When this warning symbol is shown, the governor will be disabled until the flight condition has been turned off. The engine must be started with the governor turned off.

Sensor Error Gyro



WARNING

⚠ The helicopter must remain motionless during the initialization process or a [SensorER] sensor calibration error may occur.

If a sensor error occurs during initialization, the sensor itself may be defective.

Please contact your region’s technical support center (the contact information can be found in the beginning of this manual).

Low battery



WARNING

⚠ The [Low Batt] warning is displayed if the receiver battery voltage falls below the [BAT/FS] voltage set within the CGY750 Governor Expert menu. If this condition lasts for more than one second, then the Battery Fail Safe function activates, and the throttle servo is brought back to idle position. This is done to warn you that the battery voltage is dangerously low and that you must land immediately.

The throttle operation can be temporarily reactivated by bringing the transmitter control stick all the way back to idle; normal throttle function will return. After 30 seconds the Battery Fail Safe function will activate again requiring you to repeat this process if necessary. The model should be landed as soon as possible.

Memory writing indicator



WARNING

⚠ Do not power off the CGY750 when the Memory writing symbol is displayed.

When a setting is changed within the CGY750 the new value must be written to memory. The “Memory writing indicator” is displayed during this process. This process may take up to two seconds, and the power must not be switched off during this time.

If the power is switched off during the writing process, then all of the settings may be lost.

SETTING MENUS

WARNING

⚠ Always exit the Setting Menu and return to the home screen before flying your model. The gyro operation is disabled within several of the settings menus to ease set up.

⚠ Always check the operation of the CGY750, verify that the controls are operating the correct direction and ensure the gyros are correcting in the proper direction for all axes prior to attempting to fly the model.

The data [+] and [-] keys are used to navigate through the Setting Menus: [RUD.Gyro], [AIL.Gyro], [ELE.Gyro], [SWASHset], [Governor]* and [S.BUS] Basic menus. Once the desired menu is shown press and release the mode [+] or [-] key to show the next or setting items respectively.

The expert menus are entered or exited by pressing and holding the mode [+] or [-] key for one second. To exit the current menu simply go back to the Basic Settings Menu for the function (for example, [AIL.Gyro - Basic]) and press and release the mode [+] or [-] key until the home screen is shown.

Please see the Setting Menu diagram for a complete listing of the Home Screen, Basic and Expert menus.

*The [Governor] setting menu is not displayed if the Operating Mode has been set to [Gyro+Thr] or if the swash plate type has been set to the H4 xx type.

Since S.BUS sends all 18 channels (may be limited by your transmitter) over a single wire, it is necessary to assign a CGY750 function (such as AIL, ELE or PIT) to each channel. The channel assignments are performed within the [S.BUS].Basic menu.

If a function is not going to be used, then it must be set to [INH]. For example, if the RotHD.Gn and R.GN remote gain functions are not going to be used, then set them to [INH] and the CGY750 will then allow you to make gain adjustments within the respective menu.

⚠ WARNING

① Always verify that the S.BUS function assignments match your transmitter's function (in the FUNCTION menu) assignments. If any changes are made within the transmitter function assignments, then it will also be necessary to make the changes within the S.BUS function assignments.

S.BUS BASIC MAP

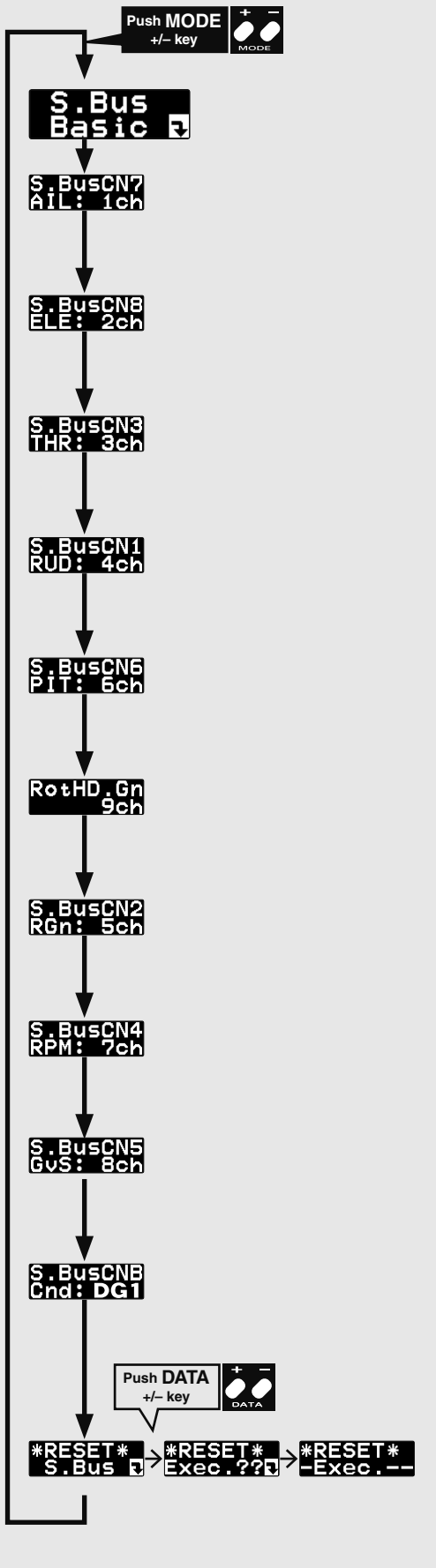

(1) S.BUS connection setting: start display

Use the mode [+] or [-] keys to navigate through the menu.

Setting ranges common: 1 ~ 16ch, DG1, DG2, INH

(2) S.BUS setting: Aileron channel [default: 1ch]

Using the data [+] or [-] keys to set the correct channel number.

(3) S.BUS setting: Elevator channel [default: 2ch]

Using the data [+] or [-] keys to set the correct channel number.

(4) S.BUS setting: Throttle channel [default: 3ch]

Using the data [+] or [-] keys to set the correct channel number.

(5) S.BUS setting: Rudder channel [default: 4ch]

Using the data [+] or [-] keys to set the correct channel number.

(6) S.BUS setting: Pitch channel [default: 6ch]

Using the data [+] or [-] keys to set the correct channel number.

(7) Rotor head gain: AIL and ELE gain channel [default: 9ch]

Using the data [+] or [-] keys to set the correct channel number.

(8) S.BUS setting: RUD gain channel [default: 5ch]

Using the data [+] or [-] keys to set the correct channel number.

(9) S.BUS setting: RPM channel [default: 7ch]

Using the data [+] or [-] keys to set the correct channel number.

(10) S.BUS setting: GOV. on/off channel [default: 8ch]

Using the data [+] or [-] keys to set the correct channel number.

(11) S.BUS setting: Condition on change channel [default: DG1]

Using the data [+] or [-] keys to set the correct channel number.

NOTE: DG1/DG2 are the C1/C2 recommended channels for changing Condition Data.

(12) S.BUS data reset

This resets the S.BUS channel assignments back to the defaults. Press the data [+] key and [Exec ???] will be displayed as a confirmation. Press data [+] to confirm the reset back to the default settings.

The [SWASHset] → Basic menu contains all of the functions necessary to set up the swash plate servos and to set up all swash plate mixing functions.

SWASH BASIC MAP. 1/2

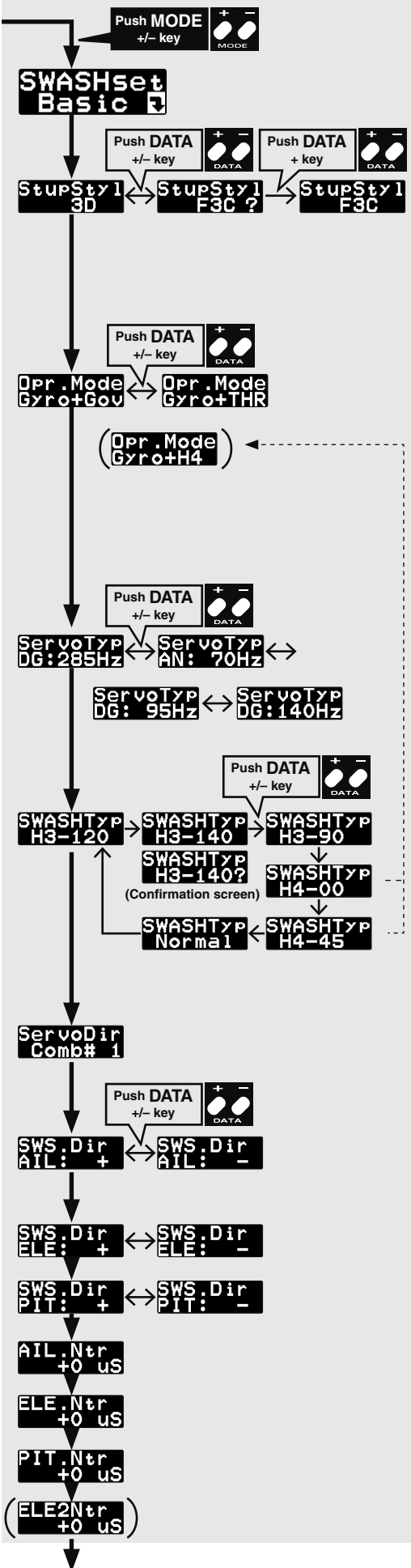

(1) Start display

The editing menus are scrolled by pushing the MODE+ or – key

(2) Setup styl [default: 3D]

3D mode contains a proven set of parameters which are good for not only 3D but also F3C flying. F3C Mode is for Advanced F3C tuning only.

*The changed menu is indicated on a map.

***When the style is changed, setting of AIL/ELE/RUD is initialized.**

(3) Operation mode [default: Gyro+Gov]

This selects the operating mode of the CGY750.

[Gyro+Gov] Both the gyros and the governor are operational.

[Gyro+THR] The gyro is operational, and the governor is disabled. The throttle channel from the receiver is passed through to the [TH/E2] port on the CGY750.

[Gyro+H4] Must be selected when a [H4 xx] swash plate type is selected. This disables the governor and throttle servo output and the [TH/E2] port on the CGY750 is now the second “Elevator” [E2] servo output.

⚠ WARNING

⚠ If the operating mode has been changed, then the CGY750 must be reset by powering down and then powering back up.

(4) Servo type [default: DG:285Hz]

This selects the swash servo types. There are four kinds of the servo driving frequency selection, AN:70Hz, DG:95Hz, DG:140Hz, DG:285Hz. Previous version supported Analog= AN: 70Hz and DG:1520= DG:285Hz only. All Futaba digital servos can be operated with fastest DG:285Hz mode but some of other brands servos do not support DG:285Hz mode. In this case, select the proper servo driving frequency per the manufacturer’s specifications.

⚠ WARNING

⚠ Read your servo instruction sheet to determine the proper servo settings. The servo type parameter within the CGY750 must match the type of servo you are using. Incorrect setting may damage the CGY750 or the servo. Incorrect setting may also result in a loss of control during flight.

(5) Swash type [default: H3-120]

Select the swash plate type. Pushing the DATA+ or – key, display shows the confirmation screen as [Type]? Pushing the SET key, the type is changed. Pushing the RSET key or no operation the key for more than 1 second, the display returns to previous setting. When the type is changed, all swash parameter are reset.

⚠ WARNING

⚠ All of the swashplate parameters are reset when the swash plate type is changed. Please proceed through the entire setup process before attempting to fly the model.

(6) Swash servo direction setting [default: 1]

Using different servo combinations will create the proper swashplate servo movement electronic CCPM models (eCCPM) In the H3-xx swash mode, three of the swash servos directions are changed by pushing the DATA[+] or DATA[-] key. Choose the combination number which produces level swashplate travel with a collective pitch input from the transmitter. There are 8 combination choices for the H3-xx swash mode. On H4-xx swash mode, there are 16 combination choices. After selecting the combination number, aileron, elevator, pitch, and 2nd elevator servo parameters are automatically set.

NOTE: Occasionally the aileron or elevator function directions are reversed even though collective pitch direction is correct. In this case, change the direction of the affected function using the SWS.Dir parameter. The sign of its value will change from (+) to (-) or vice versa.

(7) Swash direction setting [default: +]

This selects the aileron, elevator and collective pitch direction. Reverse the direction when the stick movement and swash movement are opposite.

(8) Servo neutral adjustment [default: 0µS ranges: -116~0~+116µS]

This parameter is a subtrim or individual neutral adjustment for each of the swash plate servos. All servo arms should first be positioned as centered as possible to the control linkage with the collective stick positioned at 0 degrees collective usually centered at half stick. Only then and if needed should neutral adjustments be made, and the neutral adjustment value should be kept as small as possible. The ELE2 neutral adjustment only works if the H4-xx swash plate type has been selected.

To use this parameter select the servo you would like to adjust and press the DATA [+] or [-] key to position the servo as desired.

SWASH BASIC MAP. 2/2

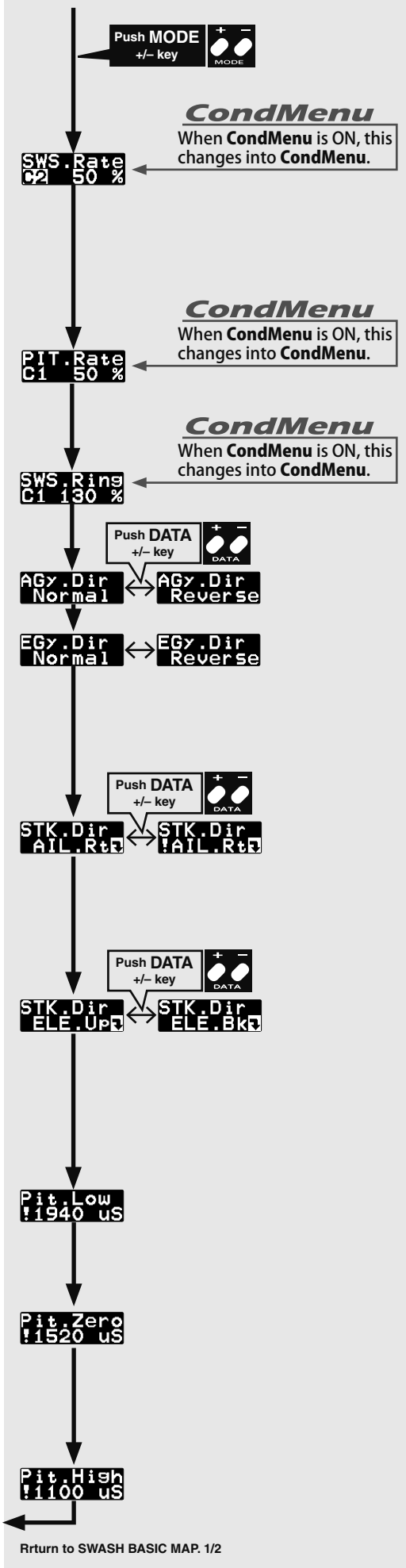

(9) Swash Rate (rate adjustment) [default: 50% ranges: 0~100%]

The Swash Rate settings are used to adjust the amount of throw-based cyclic pitch is allowed for roll (aileron) and pitch (elevator). The one setting applies to both roll and pitch axes; they are not individually adjusted. Use the Data [+] or [-] key to make an adjustment.

(DUAL RATES MUST BE 100)
-Suggested amount of base cyclic pitch

- 800 size – 10 degrees
- 700 size – 9 degrees
- 600 - 550 size – 8 degrees
- 500 size 7 degrees
- 450 and below- 6 degrees

(10) Pitch Rate (rate adjustment) [default: 50% ranges: 0~100%]

The [PIT.Rate] is the amount of collective pitch travel allowed. A good starting range for Sport, 3D and F3C is +/-10 to +/-12 degrees. Use the Data [+] or [-] key to make an adjustment. 50% ranges: 0~100%

(11) Swash ring [default: 130%]

This parameter is used to prevent binding of the swash plate servos when the transmitter control stick is moved toward a corner (for example, full right and full aft cyclic). Press the Data [+] or [-] key to adjust the value.

(12) Aileron (roll)/ Elevator (Pitch) Gyro direction setting [default: Normal]

This parameter controls which direction the CGY750 (roll / pitch axis) will compensate when the helicopter rolls (pitches). Pick the helicopter up and roll the helicopter to the right. The CGY750 should compensate by adding left cyclic to the swash plate. (Pick the helicopter up and rotate the nose of the helicopter downward. The CGY750 should compensate by adding aft cyclic to the swash plate.) If the CGY750 compensates in the wrong direction, then it will be necessary to reverse the Compensation Direction setting by pressing the [+] or [-] data key once.

⚠WARNING

❗ Verify that the CGY750 compensates in the correct direction before flight. If the compensation direction is incorrect the model will roll and/or pitch uncontrollably at lift off.

(13) Aileron direction memorizing

This parameter teaches the direction of aileron swashplate movement to the CGY750. Move the aileron stick to RIGHT full and push the DATA [+] or [-] key. The RIGHT direction of the aileron data will be saved to CGY750. To confirm the setting, move the aileron stick to full RIGHT, and the “!” mark will appear on the display. This procedure must be done for the Pirouette and Pitch compensations to function correctly.

(14) Elevator direction memorizing

This parameter teaches the direction of elevator swashplate movement to the CGY750. Move the elevator stick to full back (pull) and push the DATA [+] or [-] key. The back direction of the elevator data will be saved to CGY750. To confirm the setting, move the elevator stick to full back, and the “!” mark will appear on the display. This procedure must be done for the Pirouette and Pitch compensations to function correctly.

(15) Pitch low memorizing [default: 1940µS]

This parameter saves the negative collective pitch point into the CGY750. Move the collective pitch stick to full negative pitch and push DATA [+] or [-] key. Full negative pitch signal will be saved to the CGY750. The display shows “!” when the stick is at the saved point. The negative collective pitch setting must saved into the CGY750 for Pirouette and Pitch compensations and/or linkage compensation to function correctly

(16) Pitch zero memorizing [default: 1520µS]

This parameter saves the zero collective pitch point into the CGY750. Move the collective pitch stick to zero degrees pitch and push DATA [+] or [-] key. The zero degrees pitch signal will be saved to the CGY750. The display shows “!” when the stick is at the saved point. The zero degrees pitch setting must saved into the CGY750 for Pirouette and Pitch compensations and/or linkage compensation to function correctly.

(17) Pitch high memorizing [default: 1100µS]

This parameter saves the full positive collective pitch point into the CGY750. Move the collective pitch stick to full positive pitch and push DATA [+] or [-] key. The full positive pitch signal will be saved to the CGY750. The display shows “!” when the stick is at the saved point. The positive collective pitch setting must saved into the CGY750 for Pirouette and Pitch compensations and/or linkage compensation to function correctly.

Items (1) – (16) are used to keep the swash plate level at high and low collective pitch to cyclic interactions and cyclic pitch to collective pitch interactions. To enter the detail menu, navigate to the Basic menu, press and hold the mode [+] key for one second and the menu will change from the Basic to Detail. To exit the Detail menu press and hold the mode [+] key for one second and the Basic menu will be displayed.

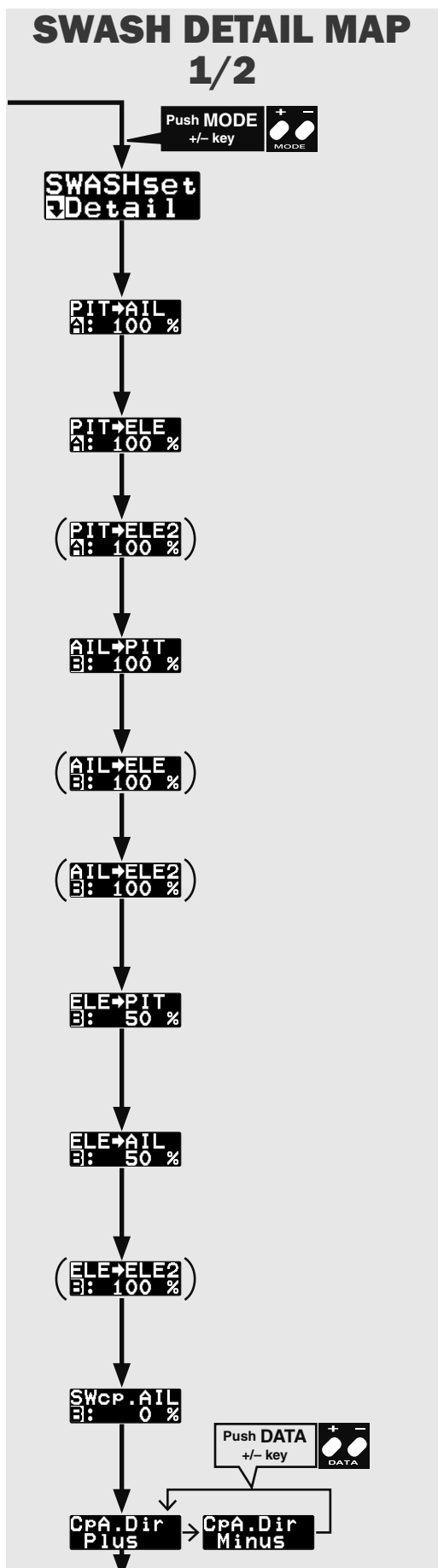

(1) Swash expert setting: start display
Use the mode [+] or [-] keys to navigate through the menu.

(2) PIT→AIL mixing rate [default: 100%] [ranges: 30% ~ 150%]
Going from MID to HIGH and MID to LOW collective pitch check that the swash plate is traveling flat throughout the entire range. Using the (+/-) Data keys to level the swash plate on the aileron axis to the middle point by raising or lowering the aileron servo.

(3) PIT→ELE mixing rate [default: 100%] [ranges: 30% ~ 150%]
Going from MID to HIGH and MID to LOW collective pitch check that the swash plate is traveling flat throughout the entire range. Using the (+/-) Data keys to level the swashplate on the elevator axis to the middle swash position by raising or lowering the elevator servo.

(4) PIT→ELE2 mixing rate [default: 100%] [ranges: 30% ~ 150%]
This parameter adjusts the pitch to 2nd elevator mixing rate. The rates can both be adjusted individually for both full high and low collective positions. It is only available at **H4 swash mode**.

(5) AIL→PIT mixing rate [default: 100%] [ranges: 30% ~ 150%]
At middle collective pitch check that during right to left and left to right aileron action the swash plate is staying level on the elevator and collective pitch axis. If the swashplate is rising or falling with aileron inputs, use the Data (+/-) key to raise or lower the swash plate to match the middle point during aileron inputs.

(6) AIL→ELE mixing rate [default: 100%] [ranges: 30% ~ 150%]
This parameter adjusts the aileron to elevator mixing rate. The rate can be adjusted for left and right directions individually. It is only available for **H4-45 swash mode**.

(7) AIL→ELE2 mixing rate [default: 100%] [ranges: 30% ~ 150%]
This parameter adjusts the aileron to 2nd elevator mixing rate. The rate can be adjusted for left and right directions individually. It is only available for **H4-45 swash mode**.

(8) ELE→PIT mixing rate [default: 50%(H3-120), 100%(except H3-120)] [ranges: 30% ~ 150%]
During back and forward elevator inputs at middle collective, check if the swash plate is raising or lowering during the input. If it is moving use the Data (+/-) key to raise or lower the swash plate to match the middle point during elevator inputs.

(9) ELE→AIL mixing rate [default: 50%(H3-120), 100%(except H3-120)] [ranges: 30% ~ 150%]
While moving the elevator back and forth at middle collective, check to make sure the aileron axis is staying level. Use the Data (+/-) key to raise or lower to level the swash plate during full forward and back elevator input.

(10) ELE→ELE2 mixing rate [default: 100%] [ranges: 30% ~ 150%]
This parameter adjusts the elevator to 2nd elevator mixing rate. The rate can be adjusted for up and down directions individually. It is only available for **H4 swash mode**.

(11) Linkage compensation aileron [default: 0%] [ranges: 0% ~ 100%]
At HIGH pitch and LOW pitch check to make sure that the swash plate is staying level on the elevator and collective axis when using aileron inputs. If the swashplate is raising or falling, use the Data (+/-) key to keep the swash plate position the same as middle during aileron inputs.
NOTE – check all four directions: high/right; high/left; low/right; low/left

(12) Compensation direction of the aileron [default: plus]
If the above Data (+/-) correction from 0-100 is NOT in the correct compensation direction, change the value from PLUS or MINUS using the Data (+/-) key.

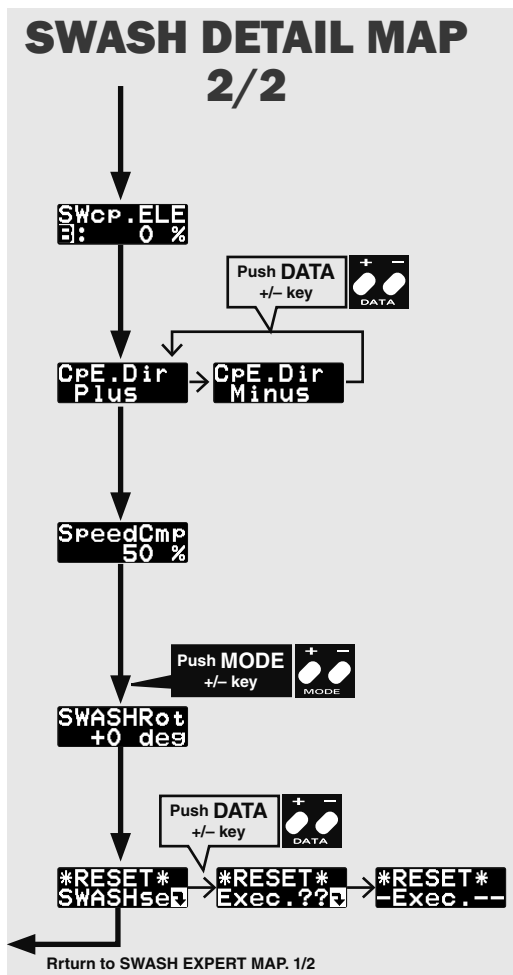

(13) Linkage compensation elevator [default: 0%] [ranges: 0% ~ 100%]

At HIGH pitch and LOW pitch check to make sure that the swash plate is staying level on the aileron and collective axis when using elevator inputs. If the swashplate is raising or falling, use the Data (+/-) key to keep the swash plate position the same as middle during elevator inputs.

NOTE – check all four directions: high/back; high/forward; low/back; low/forward.

(14) Compensation direction of the elevator [default: plus]

If the above Data (+/-) correction from 0-100 is NOT in the correct compensation direction, change the value from PLUS or MINUS using the Data (+/-) key.

(15) Speed compensation [default: 50%(H3-120), 0%(except H3-120)] [ranges: 0% ~ 100%]

In 120 degree CCPM all servos do not travel the same distance on elevator input. Having previously set the ELE-PIT and ELE-AIL parameters, if during FAST movement of the elevator axis the swash plate is not staying level, use the Data (+/-) key to match all servo speeds (+ will slow the Aileron/Pitch Servo – will reduce speed comp on Aileron/Pitch Servo)

(16) Swash rotation [default: 0 deg] [ranges: -90 deg ~ +90 deg]

Using the Data (+/-) key electronically add rotor head phasing to the swash plate controls. If possible, it is recommended to use mechanical phasing adjustment, but if the rotor head does not allow this and you feel that the model is NOT flying axially on each control input, using this parameter can be used to adjust the pure reaction of each axis in flight. (Typically advanced phasing on clockwise rotor disk and a slight clockwise increase in swashplate alignment vs rotor axle are needed to create an axial reaction, vice versa for a counterclockwise rotor disk model.)

(17) Data reset

This resets all of the Swashplate parameters back to the default values. Press the data [+] key once, and [Exec ??] is shown as a confirmation. Press the data [+] key again to confirm the operation and all of the gyro parameters will be reset.

TX AILERON / ELEVATOR GYRO GAIN SET-UP

: TX Set-up for adjusting cyclic gains via the transmitter.

Using the Remote Gain Functions (roll, pitch and yaw)

1. Some Futaba transmitters contain auxiliary gain functions for aileron, elevator and yaw. Please refer to your transmitter’s instruction manual. Assign the GYR, GYR(AIL) and GYR(ELE) channels within the transmitter. Within the CGY750 [S.BUS] Basic menu → Rotor Head Gyro Gain “RotHd.Gn” – In the SBUS menu assigning “RotHd.Gn” to a channel will allow the Rotor head gain to be adjusted via the TX. If you are using a 6CH or less TX, setting “RotHd.Gn” to “INH” will then default the gain to “BaseGain” in the Flight Tuning menu. Suggested setting and default is CH9. Tail Rotor Gain “RGn” – In the SBUS menu assigning “RGn” to a free TX channel will allow for the tail rotor gain to be adjusted via the TX. Suggested setting and default is CH5.
2. The gyro function within your transmitter should list all three gain channels. Adjustments can be made from within this function. The gyro function can usually be assigned to various switches or conditions to offer greater adjustability. Please refer to your transmitter’s instruction manual for further details.

Setting the CGY750 gains by using endpoints or manual adjustments

⚠ WARNING

❶ Verify that the gyro compensates in the correct direction for all three axes before flight. If the compensation direction is incorrect, the model will roll, flip, or pirouette uncontrollably even before it leaves the ground.

1. If your transmitter does not support the remote gain adjustment it is still possible to use spare channel on the transmitter to make the adjustments. Assign unused channel (verify that these channels are not assigned or operated by a switch or dial) within the transmitter. Set the [S.BUS.Basic] → “RotHd.Gn” channels to the appropriate channel. Use the end point adjustment within your transmitter for these channels to make the gain adjustments and the reverse function within the transmitter to set the mode [AVCS/NOR]. Conditions with the transmitter may also be used to achieve different gains based upon flight modes. Please refer to your transmitter’s instruction manual for further details.

Manual gain adjustment

1. If your setup does not leave any channels free or if your transmitter does not support auxiliary gain adjustment, then it is possible to adjust the gain manually within the CGY750. Set both the [S.BUS].Basic → RotHd.Gn to [INH]. The gain adjustments are now made by entering the [Flight Tuning] → Base Gain and pressing the data [+] or [-] keys.

The [Flight Tuning] → This menu contains all of the functions to tune the helicopter to perform and feel how the pilot would like.

FLIGHT TUNING MAP

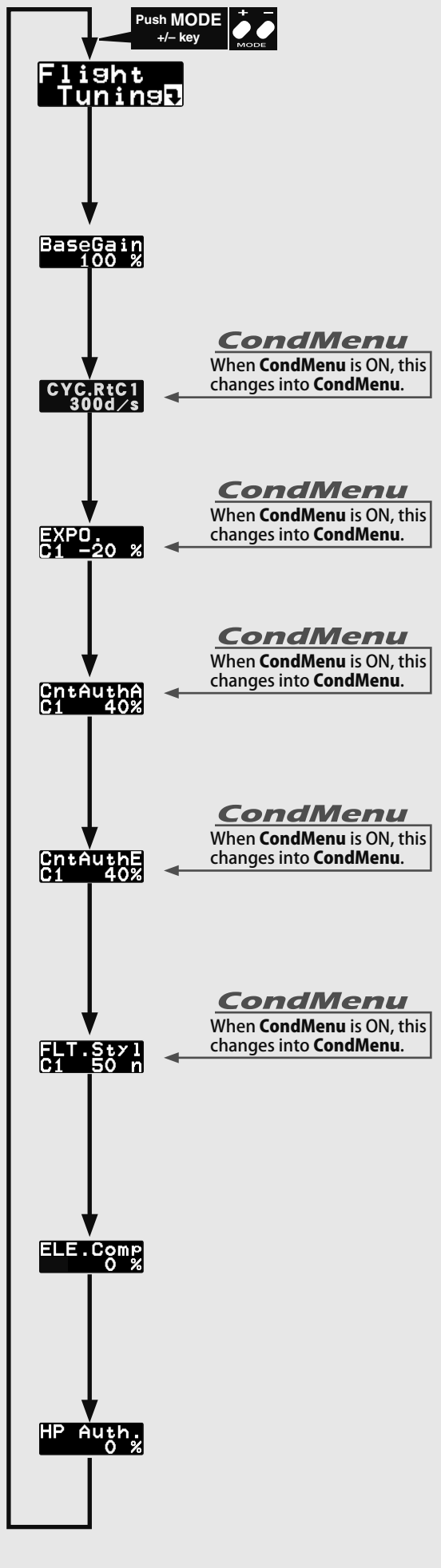

(1) Start display

The editing menus are scrolled by pushing the MODE+ or – key.

(2) Gyro base gain setting [default: 100% ranges: 0~150%]

This sets the Cyclic Gyro Base Gain. If the aileron and elevator Gain Channels are set to [INH] within the CGY750 [S.BUS]->Basic setting menu, then the remote transmitter gain adjustment is not available. Thus the actual working gain for the cyclic gyros is set by using data [-] or [-] keys within this parameter.

Set to 100, a TX Gain value of 100% will display 100% on the CGY750. If a pilot is in need of more gain, base gain can be increased to allow the gain on the CGY750 to be higher than 100%.

NOTE – If using a 6CH or less Base Gain is equivalent to the rotor head gain and can be adjusted manually on the gyro instead of via TX.

(3) Cyclic rate setting [default: 300d/s ranges: 10~500d/s]

Cyclic rate sets the maximum cyclic pitch and roll rate (d/s) as limited by the model's ability to reach that set rate. Pitch and roll rates are set together with this single parameter.

(4) Exponential [default: -20% ranges: -100~0~+100%]

Tune the exponential as desired to soften or sharpen the feel of the cyclic controls around center stick. NEGATIVE values soften control feel; POSITIVE values sharpen control feel. NOTE that any exponential present in the TRANSMITTER adds to the value set in the CGY750.

(5) Control Authority Aileron [default: 40% ranges: 0~100%]

Aileron Control Authority changes the rate at which the gyro will try to achieve the set Cyclic rate. A higher value will create a quicker accelerated reaction to a stick input to reach and stabilize to the CYC Rate value; a lower value will reach the desired CYC Rate slower and accelerate slower to the desired angular rate. (NOTE – Setting this value too high could lead to a jerky feeling when making FAST stick corrections, a value too low will give you the impression the model is not following the pilot's stick inputs. Values of 30-70 are useful for most helicopters.

(6) Control Authority Elevator [default: 40% ranges: 0~100%]

Elevator Control Authority changes the rate at which the gyro will try to achieve the set Cyclic rate. A higher value will create a quicker accelerated reaction to a stick input to reach and stabilize at the CYC Rate value; a lower value will reach the desired CYC Rate slower and accelerate slower to the desired angular rate.

NOTE – Setting this value too high could lead to a jerky feeling when making FAST stick corrections; a value too low will give the impression the model is not following the pilot's stick inputs. Values of 30-70 are useful for most helicopters.

(7) Flight style [default: 50n ranges: 0~100n]

Increasing this value will create a more robotic reaction to the stick, leaving the pilot with the impression that the model is locked into in a position after an input. It will also tend to have a more calculated feeling when making inputs.

-Lowering the value will make the model feel more fluid and easy to rotate with the stick input. The model will feel a little more lively during faster cyclic movements and direction changes.

(8) Elevator pre compensation [default: 0 ranges: 0~100%]

On a clockwise rotating disk helicopter naturally will want to pull the nose towards the rotor disk with positive blade pitch and push the nose away with negative pitch. In an instance of a slower servo set-up or larger (heavier) rotor blades, a small amount of elevator pre compensation may be needed to keep the nose of the helicopter flat at all times during collective pitch changes. In MOST cases with helicopter high speed servos and standard 3D rotor blades, this function is not needed. If you do notice a slight tendency for the nose to try to rise or fall with collective input, increasing ELE COMP will reduce this behavior.

(9) High pitch authority [default: 0% ranges: 0~100%]

When a rotor blade's angle of attack is increased, the rotor blade becomes less reactive, and in turn the helicopter might not feel as reactive at high pitch angles. If you want to increase the reaction of the cyclic during loaded and high pitch maneuvers, HP AUTH will increase control authority and can make the helicopter feel more linear under high pitch or a loaded-down situation. Some helicopters with direct link CCPM may use this to increase stability at high collective pitch flying as well. If a helicopter feels good for normal flying, but not the same during loaded situations, HP Authority can be used to make it feel more linear. If HP Authority is set very high, the helicopter will feel more aggressive at high pitch than around neutral.

The [RUD.Gyro].Basic menu contains all of the functions necessary to setup the CGY750 tail gyro for operation.

⚠ WARNING

⊘ Do not connect the tail rotor servo to the gyro until the servo type has been selected. Operating the servo using the incorrect setting may damage the CGY750 or the servo.

RUD GYRO BASIC MAP

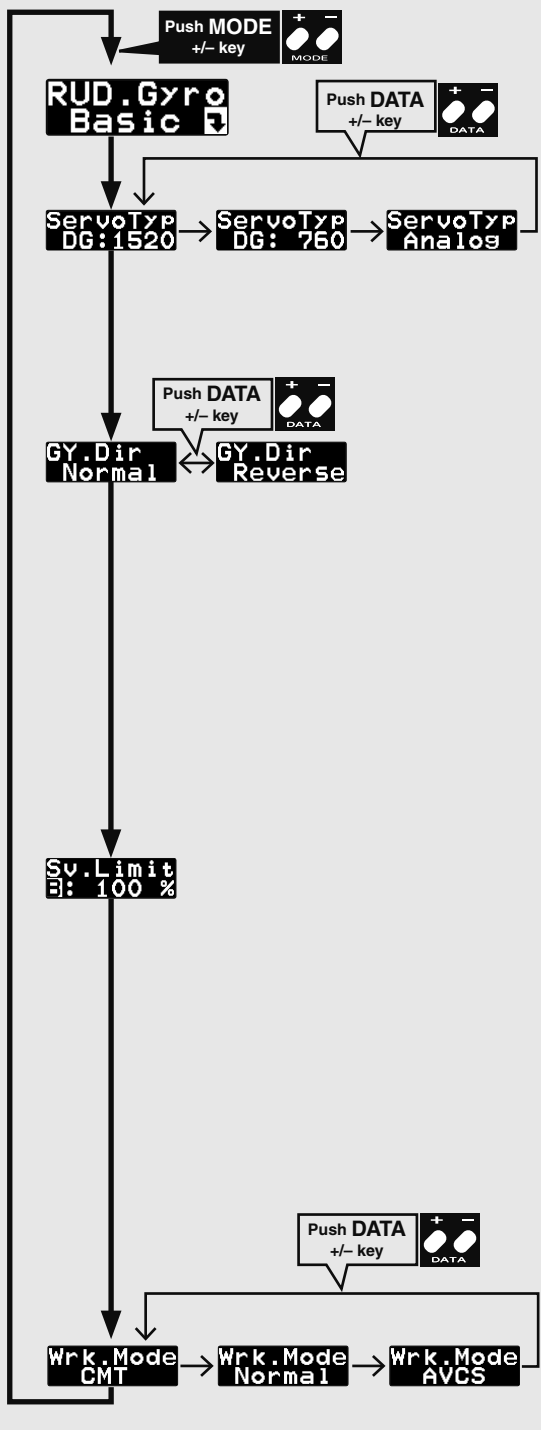

(1) Start display

Use the mode [+] / [-] keys to navigate the setting menus.

(2) Servo type [default: DG:1520]

Select the appropriate setting for the tail rotor servo that you are using. Use the data [+] or [-] key to choose from the following servo types: DG1520, DG760 or Analog.

DG 760: BLS276SV, BLS251SB, BLS251, S9256, S9251
 DG 1520: BLS254, BLS257, S9254, S9257

⚠ WARNING

ⓘ Read your servo instruction sheet to determine the proper servo settings. The servo type parameter within the CGY750 must match the type of servo you are using. Incorrect setting may damage the CGY750 or the servo. Incorrect setting may also result in a loss of control during flight.

(3) Gyro direction [default: Normal]

This parameter controls which direction the CGY750 (yaw axis) will compensate when the helicopter rotates. Hold the tail rotor linkage over the linkage ball on the servo, pick the helicopter up by the main shaft and rotate the mechanics counter-clockwise. The CGY750 should compensate by adding clockwise rotation pitch to the tail rotor blades. If the CGY750 compensates by adding counter-clockwise rotation pitch to the tail rotor blades, then it will be necessary to reverse the Compensation Direction setting by pressing the [+] or [-] data key.

⚠ WARNING

ⓘ Verify that the tail gyro compensates in the correct direction before flight. If the compensation direction is incorrect the model will pirouette uncontrollably at lift off.

(4) Limit setting [default: 100%, setting range: 50~150%]

When the CGY750 is in the Sv.Limit parameter the gyro will no longer operate and the tail servo will always center when the tail rotor stick is released.

Always exit setup functions before attempting to fly the model. Before each flight always ensure that the gyros are operating and compensating in the correct direction.

The Servo Limit parameter within the CGY750 is used to set the mechanical limits for the tail rotor servo. To obtain the best performance it is recommended to set the limit in the CGY750 to 100% for both directions and then adjust the servo arm length to set the mechanical endpoints. After that has been completed use the servo limit parameter to make small adjustments that could not be made mechanically. Values between 90% and 110% are considered optimal. Navigate to the [RUD.Gyro].Basic → Sv.Limit menu and slowly move the rudder stick to the left or to the right maximum extent and use the data [+] or [-] key to increase or decrease the maximum throw. Ensure that the pitch slider does not exceed the maximum extent of travel and cause binding.

⚠ WARNING

ⓘ When using the CGY750 for the first time, or when making mechanical changes involving throw, you must check and set the servo limits again to prevent binding.

(5) Gyro working mode [default: CMT]

The available choices are CMT, Normal or AVCS. The CMT mode will allow you to select either AVCS or Normal mode via the transmitter. In Normal mode the gyro will always operate in Normal Rate Mode, and when AVCS it will always operate in AVCS Mode. Use the data [+] or [-] key to select the desired working mode.

This menu sets the governor's fundamental functions. The menu *Servo limit point setting* must be set first.

GOVERNOR BASIC MAP. 1/2

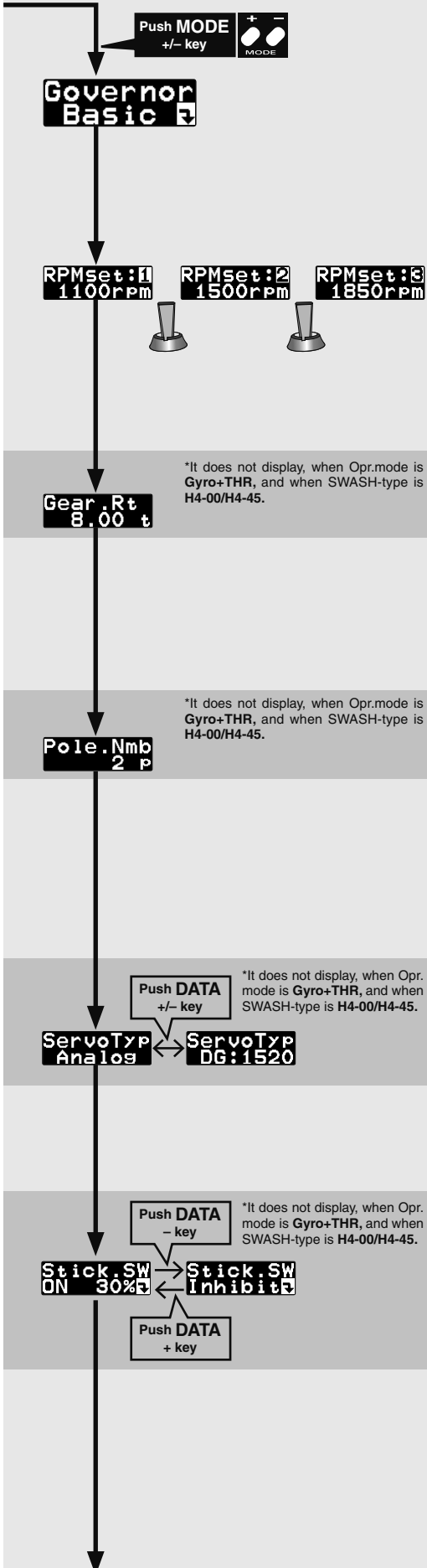

(1) Start display

The editing menus are scrolled by pushing the mode + or - key.

(2) RPM setting [range: 700 ~ 4000 rpm]

Setting the main rotor RPM. This is calculated by engine revolution with the gear ratio of the main shaft.

(3) Gear ratio [default: 8.00, range: 1 ~ 50]

Input the main rotor gear ratio by pushing the data + or-key.

(4) Pole number [default: 2p, range: 2p ~ 24p]

This parameter is used when using a direct phase sensor attachment to a brushless motor lead. Input the motor pole count as specified by the brushless motor manufacturer. When using any revolution sensor other than a direct phase sensor type, set the pole number to 2p.

NOTE: For nitro use, set to 2p.

NOTE: The input signal range of the CGY750 is 0.0v-3.0v. Exceeding this voltage range may cause damage to the CGY750.

(5) Servo selection [default: Analog]

Select the throttle servo type. Digital servos offer the best response. The type is changed by pushing data + or - key.

⚠ WARNING
 This parameter must match the type of servo you are using. Incorrect setting may damage the CGY750 or the servo, possibly resulting in a loss of control during flight.

(6) Stick switch

The governor can be activated by throttle stick position. Move the throttle stick to the desired governor on position and push SET key, memorizing that point. When you push the RSET key, the function is inhibited. When the governor on/off switch is inhibited, the stick switch is automatically turned on.

GOVERNOR BASIC MAP. 2/2

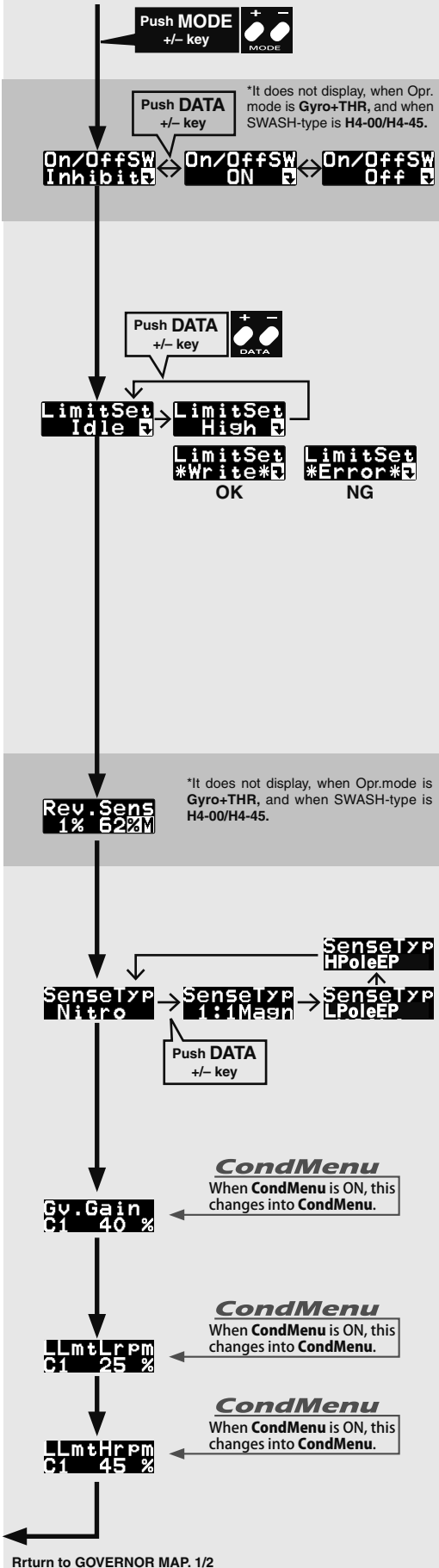

(7) Governor on/off switch [default: Inhibit]

This parameter allows turning of the governor on and off via a transmitter switch. Pushing the SET (Data+) key activates the function. The on/off direction is changed by pushing the SET key again. The function is inhibited by pushing the RSET (Data-) key.

(8) Servo limit point setting

Servo limit point setting defines the overall travel range for the throttle servo. It is fundamental for governor operation and must be set prior to other functions. Servo limits must also be reset when the throttle linkage or trim are changed.

For this setting, idling position is set first, then high position as guided by the display. Push the data + or - key to memorize. “*Write*” is displayed when the setting is completed. “Error” is displayed when the setting position is out of range (too little servo travel between low and high throttle positions).

⚠WARNING

❗ When using the CGY750 for the first time, or when making changes in the throw of a servo and its linkage, always perform the limit setting operation.

(9) Revolution sensor testing

It tests the output level of the revolution sensor. Turn the engine by hand, and check the output level. The display indicates the current level on left side numbers, maximum level on right side numbers. The output level needs to be more than 60 % for correct governor operation.

(10) Sensor type

Select the type of governor sensor:
 -Nitro (BPS-1 backplate; Magnet Type)
 -1:1 Magnet “1:1 Mag” (Magnet type applied to helicopter part that turns at the same RPM as the main rotor)
 -HPoleEP: For Electric motors 8 poles and above
 -LPoleEP: For electric motors 6 poles.

(11) Governor gain

Governor Gain. Too low of number the RPM will fluctuate with collective pitch and cyclic changes. Too high of gain the RPM will oscillate and possibly surge during flight.

(12) Low limit RPM

Low RPM Limit sets the minimum amount of throttle that the governor will command during an over-speed situation. Too low of value the engine could shut off or not recover power quickly enough during the next collective movement. If the value is set too high, the governor will not control overspeed with the rotor head is unloaded.

Use:
 LLmt Lrpm: For RPMS of 700-1700
 LLmt Hrpm: For RPMS of 1701-4000

GOVERNOR SPEED SETTING

The CGY750's rpm selection is accomplished by setting the channel in the section (9) "RPM channel" menu within the "*S.BUS Basic Setting*" to the governor speed setting channel of your system. When using an independent governor on/off switch, activate the section (7) "Governor on/off switch" function within the "*Governor Basic Setting*" section earlier in this manual.

Direct set by transmitter on Gov. mixing

- When governor mixing is used to switch the RPM of the rotor head speed, the head speed can be switched with each condition or the switch.

*For a description of the governor mixing, refer to your transmitter's manual.

Using by 3position switch

- Set the RPM at each switch position in the "(2) RPM setting" menu within the "*Governor Basic Setting*" section earlier in this manual.

GOVERNOR OPERATION

Governor operation

The CGY750 operates from 700 to 4000rpm main rotor speed. However, the engine must be running at the set speed. The CGY750 turns off the governor when the engine is starting or idling.

* Governor operation: Operation that stabilizes the engine speed at the set speed.

Condition of the governor to be on

For safety purposes, the governor is turned on when the conditions below are satisfied.

- The on/off switch conditions are set to off during power on.
- The stick switch is in the on position when it is used.
- The on/off switch is in the on position when it is used.
- Setting speed is not off.
- The engine speed exceeds to 60 % of the setting speed.
- The speed sensor is working properly.

WARNING

⚠ Safety reminder: Remember to configure your transmitter fail safe settings for not only the throttle channel but also governor ON/OFF channel to ensure the governor correctly disengages should the radio enter fail safe.

RECOMMENDED GYRO GAIN SETTINGS

Recommended gain settings:

Size	Recommended Gyro Gain
	AIL/ELE Gyro
450-550	45-55.00%
600-700	50-60.00%
750-more	55-65.00%

50% is a good starting point for rudder gain regardless of model size.

ADJUSTMENTS DURING THE TEST FLIGHT

WARNING

⚠ Always level the swashplate using the cyclic stick before applying throttle and spooling the main rotor blades up. During takeoff small corrections may be necessary. If you make large corrections while the helicopter is on the ground, it may tip over since the helicopter is firmly on the ground and the gyros are overcompensating due to the lack of movement.

⚠ Some helicopters may have a tendency to resonate/shake during spool up. Always leave the helicopter on the ground until this resonance or shaking goes away. If this issue continues, it is recommended to try some rubber skid stops or take off from a softer surface such as grass. Vibrations contribute to this ground resonance. Verify that everything on your model is balanced correctly.

*When the CGY750 is used with a ESC or BEC and a power switch is not used there is a possibility that the intermittent connection as you connect the flight battery may cause the CGY750 initialization to fail. Always ensure that the gyro has initialized properly by verifying that the gyros are compensating as the helicopter is moved. It is recommended to use a power switch on the power supply line to avoid this possibility.

Rudder Gyro Trim Flight:

The tail rotor/rudder AFR or D/R function within the transmitter is used to adjust the pirouette rate of the helicopter to suit your requirements. Do NOT use ATV or rudder channel travel adjustment for this purpose. For optimum performance, the tail rotor should be trimmed in Normal/Rate mode as closely as possible with adjustments to the tail rotor pushrod length before finalizing with transmitter trim and then memorizing that value into the CGY750.

The tail rotor gyro gain should be raised until the tail begins to oscillate quickly (also called tail "wag"). Once this point has been achieved, reduce the gain as needed a few percent at a time to eliminate the oscillation. Repeat the process for all flight conditions. The main rotor speed, tail rotor ratio, tail rotor pitch range and tail blade length play a large part in achieving optimum tail rotor performance. The gain value can vary drastically from model to model, and the exact value should not play a part in the evaluation of the gyro's performance.

TIPS FOR USING THE CGY750 GOVERNOR WITH ELECTRIC MODELS

WARNING

⚠ Safety Reminder: Remove both main and tail blades from the model and/or disengage the motor's pinion from the main gear before proceeding with any electric governor set up.

- Make sure your ESC is configured for external governor use. Refer to the owner's manual for your ESC.
- You may use either a brushless phase sensor or the traditional governor magnetic sensor with a magnet mounted in a collar on the main shaft or in the main gear. With one magnet, set the gear ratio to 1:1.
- When choosing a brushless phase sensor, observe the input signal range of the CGY750 specified in the Governor Basic section.
- Refer to the manufacturer's documentation for your electric motor to select the correct pole count when using a brushless phase sensor. Pole count is set to 2 when using a magnetic sensor.
- Set the governor Working Mode (Wrk.Mode) to "Governor" (EXPERT Menu).
- Set the servo type (ServoTyp) to DG:1520.
- Make sure you correctly calibrate your ESC.
- Make sure you calibrate the governor speed ranges in the transmitter's governor menu and set the high and low limits for throttle in the Governor Basic menu.
- If a tail "kick" or "jerk" is observed when switching from one idle-up headspeed to another, INCREASE the Revolution Up and Down delays (Rv.UpDly/Rv.DnDly - Expert Menu). Increase 2-5% at a time until the tail "kick" is suppressed.
- The greater the electronic speed control headroom built into the model as a function of its gearing, the more prone the tail will be to kicking with aggressive flying. Models geared for high headspeed but flown aggressively at low headspeed present the greatest challenge for the governor. The more optimally your model is geared for your chosen headspeed, the better the governor will function.
- Excessive governor gain worsens tail kick. Use as little gain as necessary for adequate headspeed control.
- If the model yaws nose left with aggressive collective input, activate and adjust the PIT → RUD F/F (feed forward) mixing. Increase in 2-5% increments. F/F mixing should ADD pitch to rudder with added positive or negative collective pitch assuming a CW main rotor direction.

Expert Gyro and Governor Definitions and Tuning Section

FLT.Tune EXPERT SETTING

The FLT.Tune menus allow further refinement of cyclic gyro performance. To exit the expert flight tune menu press and hold the mode [+] key for one second and the basic flight tune will display.

FLT.Tune EXPERT MAP

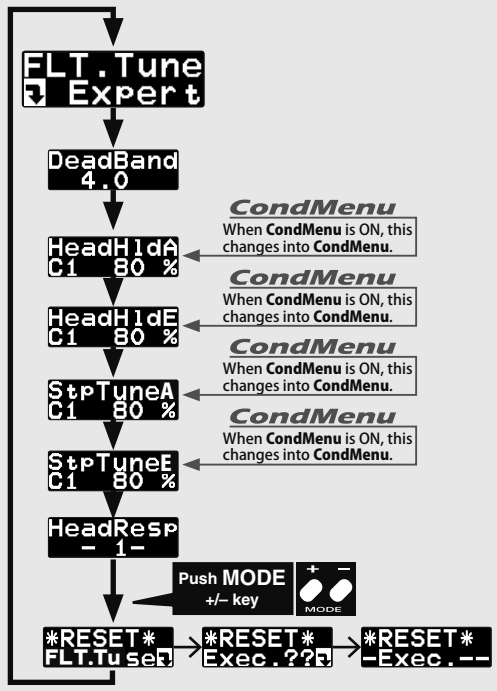

(1) Flight tune expert setting: start display

Use the MODE[+] or MODE[-] keys to navigate through the menus

(2) Dead band (AIL and ELE combined) [default: 4.0 μ S] [ranges: 0 μ S ~ 25.0 μ S]

Transmitter control dead band. If you are noticing inconsistent swashplate drift or poor initialization it could be poor TX potentiometer resolution. If you have to increase past 10.0 it is best to check calibration on your TX.

(3) Head hold [default: 80%] [ranges: 0% ~ 200%]

Heading hold aspect of the gyro control. If the helicopter is not holding angle or cyclic control rates, increasing the heading hold gain will improve holding the helicopter at a certain angle and improve the cyclic rate consistency. If this is set too high you could see an oscillation on that axis. Lowering the heading hold below default would be used if the transmitter gain is reduced and a consistent oscillation is still not fixed during flight. (HeadHld A→Aileron HeadHld E→Elevator)

(4) Stop tune A [default: 80%] [ranges: 0% ~ 250%]

Cyclic stop tuning on the aileron axis. If the helicopter continues to coast after an after an ail roll, lowering "StpTuneA" will create a harder stop action to remove the coasting. If the helicopter bounces on the aileron axis after an aileron control input, increasing "StpTuneA" will reduce bounce.

(5) Stop tune E [default: 80%] [ranges: 0% ~ 250%]

Cyclic stop tuning on the elevator axis. If the helicopter after an elevator flip continues to coast, lowering "Stop tune E" will create a harder stop action to remove the coasting. If the helicopter continues to coast after an elevator flip, lowering the "Stop tune E" will reduce bounce.

(6) Head Response [default: 1] [ranges: 1 ~ 10]

Head Response matches the gyro control speed to that which the helicopter is capable of reacting. In a standard helicopter a Head Response of 1 should always be used, but on some scale applications, or uniquely designed rotor heads, increasing head response might be needed to cure over correction of the gyro.

(7) Data reset

RUDDER GYRO EXPERT SETTING

The rudder Expert menu allows for further refinement of the tail rotor gyro performance. To enter the Expert menu first navigate to the Basic menu and then press and hold the mode [+] key for one second. The menu will change from the Basic to Expert. To exit the Expert menu press and hold the mode [+] key for one second and the Basic menu will be displayed.

RUD GYRO EXPERT MAP

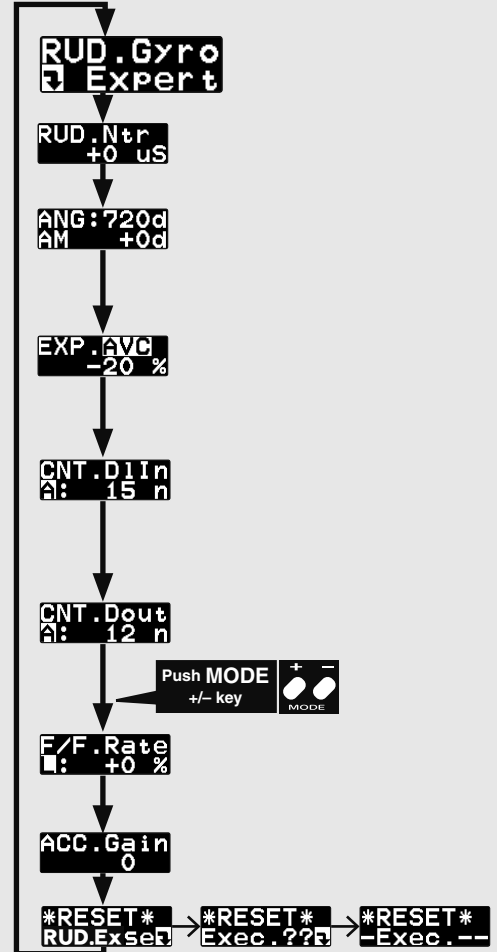

(1) Rudder gyro expert setting: start display

Use the mode [+] or [-] keys to navigate through the menu.

(2) Rudder servo neutral setting [default: 0 μ S] [ranges: -140 μ S ~ +140 μ S]

This parameter is used to set the neutral position of the rudder servo. Position the rudder servo arm as perpendicular as possible to tail rotor pushrod prior to making adjustments with this parameter. Press the data [+] or [-] key to make adjustments.

(3) Pirouette speed [default: 3D=720deg/sec] [ranges: 100~999deg/sec]

This parameter adjusts the maximum pirouette speed of the tail rotor that the gyro will allow at 100% dual rate. The bottom of the line shows the actual pirouette speed of the rudder. Use the data [+] or [-] key to adjust the maximum commanded pirouette rate.

(4) Rudder exponential [default:-20%] [ranges: -100% ~ +100%]

This parameter sets the feel of the tail rotor control around center. When set to [0] the control curve is linear. Using a [+] value the tail rotor will be more sensitive around neutral, and using a [-] value will soften the feeling around neutral. The RUD EXP parameter in your transmitter can also be used to tune the tail rotor to a desired feeling.

(5) Control delay In [default: 3D=15, Sports=12] [ranges: 0 ~ 20]

This parameter sets the delay as you move the stick from neutral toward left or right. Larger values result in a softer tail rotor feel off center. This parameter must be adjusted individually for LEFT and RIGHT tail rotor commands. Use the data [+] or [-] key to adjust the value.

(6) Control delay Out [default: 3D=12, Sports=10] [ranges: 0 ~ 20]

This parameter sets the delay when the stick is returned back to the neutral position. This parameter is useful to tune how aggressively the tail rotor stops following a pirouette. The higher the value, the softer the stop. This parameter must be adjusted individually for LEFT and RIGHT tail rotor commands. Use the data [+] or [-] key to adjust the value.

(7) F/F mixing rate [default: 0%] [ranges: -100% ~ +100%]

Feed Forward mix is used to counteract sudden increases in torque from the motor during fast collective pitch changes. If you notice a tail kick, using (right rudder on Clockwise rotor disk, left rudder on CCW) F/F mixing can be tuned to reduce the tail kick.

(8) F/F mixing acceleration gain [default: 0%] [ranges: 0 ~ 200%]

In low head speed situations where a lot of F/F Mixing might be needed, acc. gain boosts the input and removes it immediately after to help cure the sudden change in torque, but it does not allow the large tail rotor input to alter the axial behavior of the helicopter.

(9) Data reset

Expert Gyro and Governor Definitions and Tuning Section

GOVERNOR EXPERT SETTING

This menu sets the Governor Expert allows the user to further refine the governor settings. Push the mode + or – key for more than one second on the Governor Basic menu display, to get into the Governor Expert menu. Push mode + or – key for more than one second again on the Governor Expert menu to be returned to the Governor Basic menu.

GOVERNOR EXPERT MAP

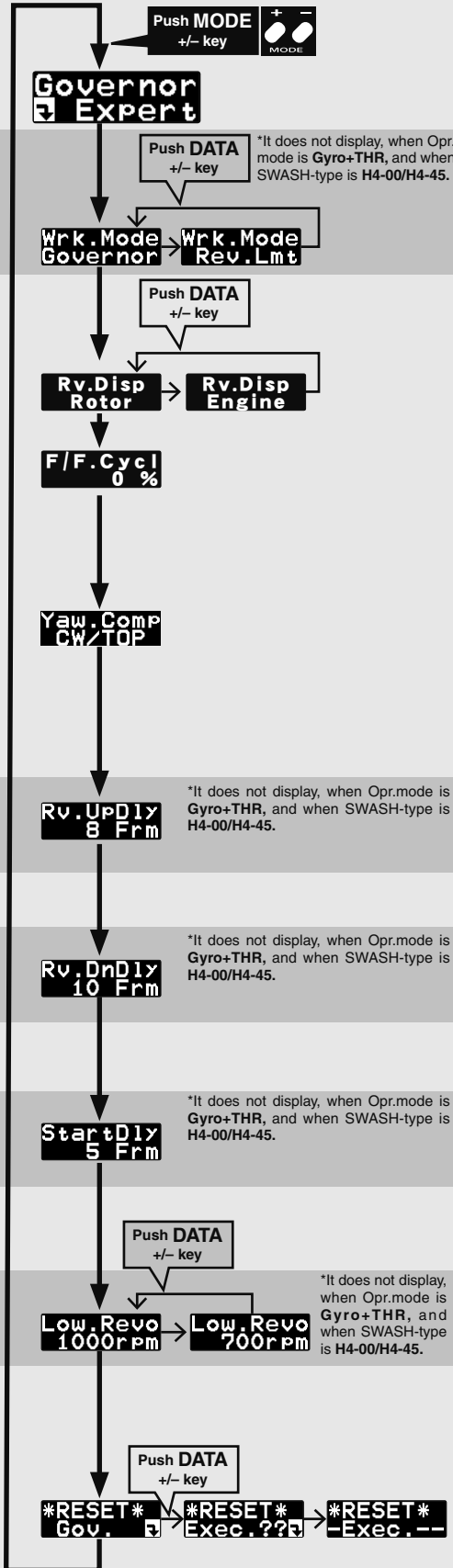

(1) Governor Expert setting: start display

Push mode + or – key, to scroll through the editing menu. Pushing mode + or – key for more than one second, brings you back to governor basic menu.

(2) Governor working mode [default: Governor]

Sets the governing type mode.

- Governor Mode – RPM is entirely controlled by the GOV once it has engaged. The GOV will do whatever it takes to hold a constant RPM throughout flight.
- Limiter Mode – Throttle control follows the throttle curves to advance the throttle position during flight, but controls the RPM during throttle reduction by not letting the RPM over speed past the set RPM.

(3) Rv. Display [default: Rotor]

Ability to choose to display desired ROTOR RPM or MOTOR RPM.

(4) Feed Forward from Cyclic [default: 0%]

Increasing the value will add throttle with cyclic commands to aid in RPM stability.

(5) Yaw Comp [default: CW/TOP]

Yaw compensation allows the governor to more rapidly correct for changes in power demands of the model resulting from yaw input. Set the mode to match the gyro installing direction, either CW/TOP, CW/BOTM, CCW/TOP, CCW/BOTM by pushing the Set key. Pushing the RSET key inhibits the function.

At the governor only mode, this parameter is inhibited.

- CW: clockwise rotor direction
- CCW: counter clockwise rotor direction
- TOP: Gyro top/name emblem facing up
- BOTM: Gyro top/name emblem facing down

(6) Revolution change up delay [default: 8] [ranges: 2 ~ 20]

How quickly the RPM changes when increasing RPM between two different RPM conditions and flight modes. A higher number slows the RPM change rate; a lower value speeds up the RPM change rate.

(7) Revolution down delay [default: 10] [ranges: 2 ~ 20]

How quickly the RPM changes when reducing RPM between two different RPM conditions and flight modes. A higher number slows the RPM change rate; a lower value speeds up the RPM change rate.

(8) Start delay [default: 5] [ranges: 2 ~ 20]

How quickly the RPM stabilizes to the set RPM from when the GOV is turned ON. A higher value slows down the spool up rate; a lower value speeds up the spool up rate.

(9) Low revolution setting [default: 1000 rpm]

This value is set to assign the lowest possible governing RPM. If the RPM is set below, or cannot reach this RPM, the governor will not engage.

(10) Governor data reset

This parameter resets also the governor parameters to default settings. The “Exec.??” is displayed by pushing data + or – key for confirmation. Pushing data+ or -key again completes the reset process, displays “-Exec.-”, and returns to the start display. By pushing mode+ or – key during confirmation display, the reset process is aborted.

When the condition menu is turned on, [CondMenu] appears as its own main menu. It becomes possible to change the function indicated by a map of [CondMenu] to 2 conditions. The function included in [CondMenu] disappears from the usual menu.

COND MENU MAP

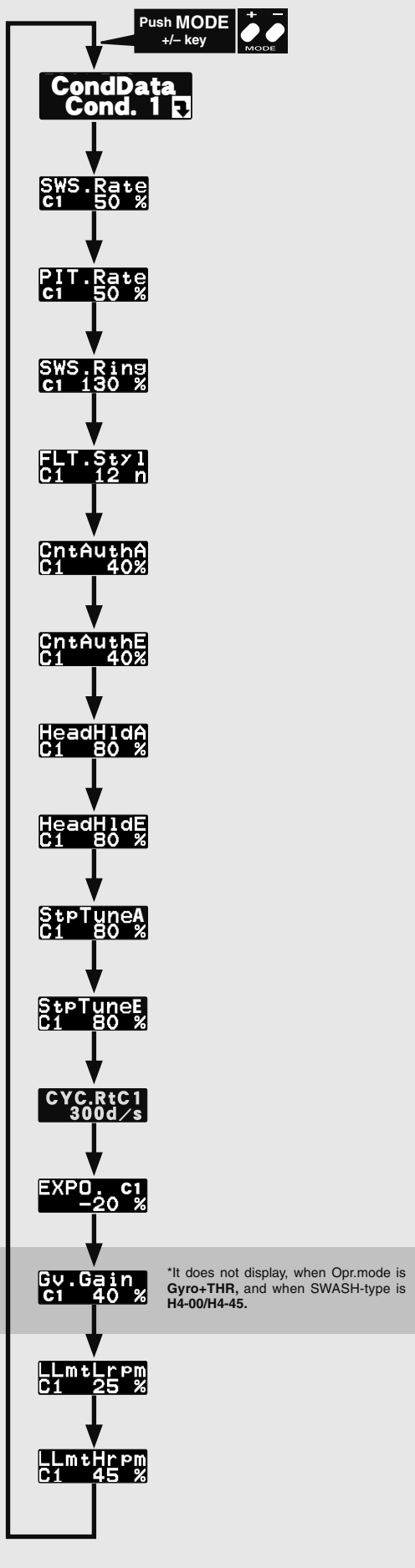

Condition menu [default: OFF]



2 conditions can be established by the switch (DG1) of the transmitter. When the condition menu is turned on, [CondMenu] appears within the main programming menu screens.

It becomes possible to change the function indicated by a map of [CondMenu] to 2 conditions.

The function included in [CondMenu] disappears from the usual menu.

Condition switch [default: DG1]

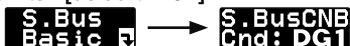

The switch channel of the transmitter can be changed in the menu of [S.BUS Basic] menu → [S.BUSCNB]

Change for Setting [C1 ↔ C2]



Push MODE +/- key for 1 second
The condition value can be changed regardless of selected condition by the TX.

When you are adjusting a condition value not in the selected condition, the visual appearance will be reversed.

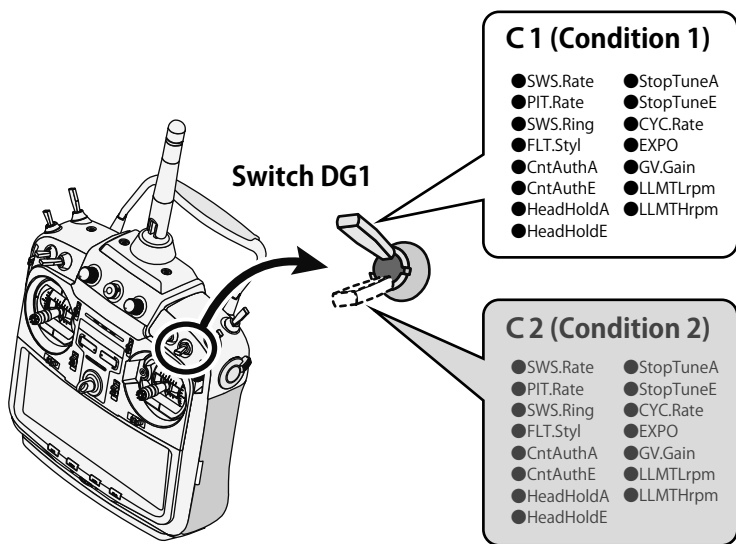

Switch Channel Rate

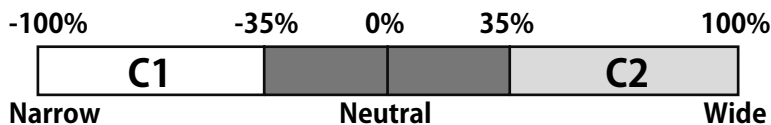



CGY750V2-3D Style-MAP

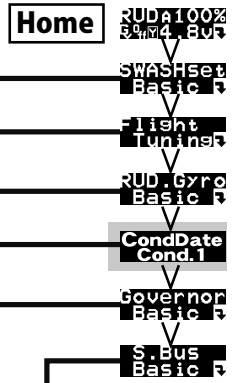

Swash Basic

- SWASHset Basic: Swash Basic Start
- StupStyl 3D: Setup Style
- Upr_Mode Gyro+Gov: Operation mode
- ServoTyp AN: 70Hz: Servo type
- SWASHtyp IG: 120: Swash type
- ServoDir Comb#: 1: Swash servo direction
- SWS_Dir AIL: +: Swash direction AIL
- SWS_Dir ELE: +: Swash direction ELE
- SWS_Dir PIT: +: Swash direction PIT
- AIL.Ntr +0 uS: Neutral adjustment
- ELE.Ntr +0 uS: Neutral adjustment
- PIT.Ntr +0 uS: Neutral adjustment
- (ELE2Ntr +0 uS): Neutral adjustment
- SWS_Rate C1: 50%: Swash rate
- PIT_Rate C1: 50%: Pitch rate
- SWS_Ring C1: 130%: Swash Ring
- AGy_Dir Normal: AIL gyro direction
- EGy_Dir Normal: ELE gyro direction
- STK_Dir AIL: Rtr: AIL direction memorizing
- SK_Dir ELE: Rtr: ELE direction memorizing
- Pit_Low 11940 uS: Pitch low memorizing
- Pit_Zero 11520 uS: Pitch zero memorizing
- Pit_High 11100 uS: Pitch high memorizing

Flight Tuning

- light Tuning: Flight Tuning Start
- baseGain 100%: Gyro base gain
- CYC_Rate 3000/5: Cyclic rate
- EXPO_C1 -20%: Exponential
- CntAuthA C1: 40%: Control Authority AIL
- CntAuthE C1: 40%: Control Authority ELE
- FLI_Styl C1: 12 n: Flight style
- ELE.Comp 0%: Elevator pre compensation
- HP_Auth 0%: High pitch authority

Rudder Basic

- RUD Gyro Basic: RUD Gyro Basic Start
- ServoTyp DG: 1520: Servo type
- GY_Dir Normal: Gyro direction
- SV_Limit B: 100%: Servo limit
- Wrk_Mode GWT: Gyro working mode

Condition Menu

- CondDate Cond.1: Condition Basic Start
- SWS_Rate C1: 50%: Swash rate
- PIT_Rate C1: 50%: Pitch rate
- SWS_Ring C1: 130%: Swash Ring
- FLI_Styl C1: 12 n: Flight style
- CntAuthA C1: 40%: Control Authority Aileron
- CntAuthE C1: 40%: Control Authority Elevator
- HeadHldA C1: 80%: Head hold Aileron
- HeadHldE C1: 80%: Head hold Elevator
- StpTuneA C1: 80%: Stop tune Aileron
- StpTuneE C1: 80%: Stop tune Elevator
- CYC_Rate 3000/5: Cyclic rate setting
- EXPO_C1 -20%: Exponential
- Gv_Gain C1: 40%: Governor gain
- LLmtLrpm C1: 25%: Low limit L rpm
- LLmtHrpm C1: 45%: Low idle H rpm

Governor Basic

- Governor Basic: Gover Basic Start
- RPMSet: 11100rpm: Revolution setting
- gear_Rt 8.00: Gear ratio
- Pole.Nmb 2 p: Pole number
- ServoTyp Analog: Servo selection
- Stick_SW AN: 30%: Stick switch
- On/OffSW Inhibit: Governor on/off switch
- LimitSet Idle: Servo limit point
- Rev_Sens 1% 52PM: Revolution sensor testing
- SenseTyp Nitro: Sensor type
- Gv_Gain C1: 40%: Governor gain
- LLmtLrpm C1: 25%: Low limit L rpm
- LLmtHrpm C1: 45%: Low idle H rpm

S.BUS Basic

- S.BUS Basic: S.BUS Basic Start
- S.BUSCN7 AIL: 1ch: Aileron channel
- S.BUSCN8 ELE: 2ch: Elevator channel
- S.BUSCN3 THR: 3ch: Throttle channel
- S.BUSCN1 RUD: 4ch: Rudder channel
- S.BUSCN6 PIT: 6ch: Pitch channel
- RotHD_Gn 9ch: Rotor head gain
- S.BUSCN2 RGN: 5ch: RUD gain channel
- S.BUSCN4 RPM: 7ch: RPM gain channel
- S.BUSCN5 GVS: 8ch: Governor ON/OFF channel
- S.BUSCN6 Cnd: DG1: Condition channel
- *RESET* S.BUS: S.BUS Reset

CondMenu
When CondMenu is ON, this changes into CondMenu.

Swash Basic

Condition Menu

Governor Basic

S.BUS Basic

MODE + - : →
 DATA + - : >

Home

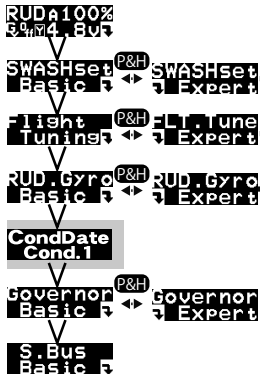

Basic⇌Expert
 (P&H)
 : Push and hold (MODE)

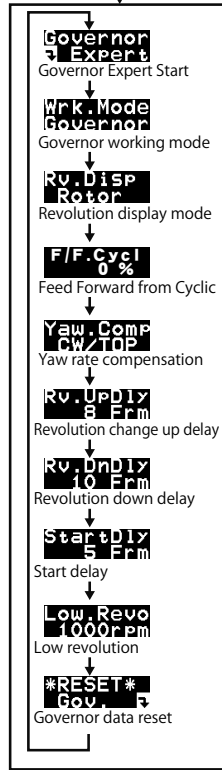

Governor Expert

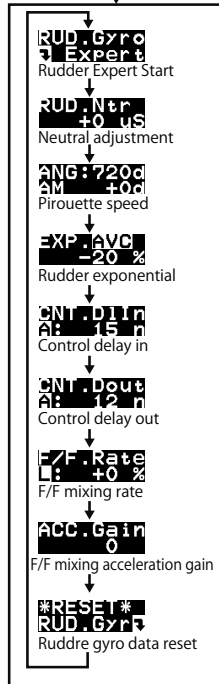

Rudder Expert

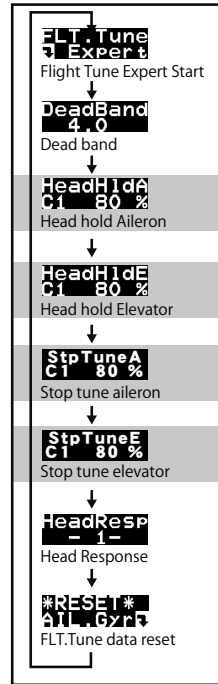

FLT.Tune Expert

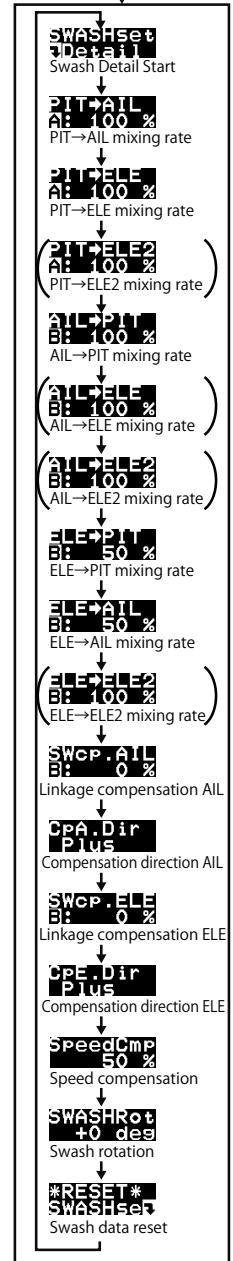

Swash Detail

() ← Only displayed in SWASH Type H4



CGY750V2-F3C Style-MAP

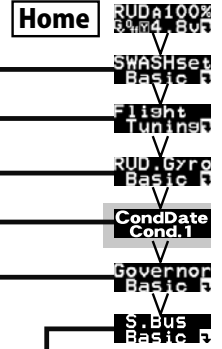

SWASHset Basic
Swash Basic Start

StupStyl F3C
Setup Style

Op Mode F3C
Operation mode

ServoTyp AN: 70Hz
Servo type

SWASHTyp HS-120
Swash type

ServoDir Comb# 1
Swash servo direction

SWS_Dir AIL: +
Swash direction AIL

SWS_Dir ELE: +
Swash direction ELE

SWS_Dir PIT: +
Swash direction PIT

AIL_Ntr +0 uS
Neutral adjustment

ELE_Ntr +0 uS
Neutral adjustment

PIT_Ntr +0 uS
Neutral adjustment

(ELE2Ntr +0 uS)
Neutral adjustment

SWS_Rate C1: 50 %
Swash rate

PIT_Rate C1: 50 %
Pitch rate

SWS_Ring C1: 130 %
Swash Ring

AGy_Dir Normal
AIL gyro direction

EGy_Dir Normal
ELE gyro direction

SIK_Dir AIL: Ret
AIL direction memorizing

SIK_Dir ELE: Up
ELE direction memorizing

Pit_Low 11940 uS
Pitch low memorizing

Pit_Zero 11520 uS
Pitch zero memorizing

Pit_High 11100 uS
Pitch high memorizing

ROT_Equa Off
Rotational equalizer

Equa_Dir Normal
Equalizer direction

Swash Basic

Flight Tuning
Flight Tuning Start

Wrk.Mode CMT
Gyro working mode

BaseGain 100 %
Gyro base gain

AIL_Sepa 5mm
Aileron separate

CYC_Rate 300d/5
Cyclic rate

Cnt.GnAIL C1: 32 %
Control Gain AIL

Cnt.GnELE C1: 36 %
Control Gain ELE

EXPO_C1 C1: -20 %
Exponential

RESPStyl C1: 12
Response style

Stab_Gn C1: 5-
Stability gain

ELE_Comp LF
Elevator pre compensation

HP_Gain 60 %
High pitch gain

Flight Tuning

RUD_Gyro Basic
RUD Gyro Basic Start

ServoTyp DG: 1520
Servo type

Gy_Dir Normal
Gyro direction

Sv_Limit B: 100 %
Servo limit

FLT_Mode 3D
Flight mode

Wrk.Mode CMT
Gyro working mode

Rudder Basic

CondDate Cond.1
Condition Basic Start

SWS_Rate C1: 50 %
Swash rate

PIT_Rate C1: 50 %
Pitch rate

SWS_Ring C1: 130 %
Swash Ring

RESPStyl C1: 12
Response style

Cnt.GnAIL C1: 32 %
Control Gain AIL

Cnt.GnELE C1: 36 %
Control Gain ELE

Stab_Gn C1: 5-
Stability gain

I.Gain_AIL C1: 80 %
Integral gain Aileron

I.Gain_ELE C1: 80 %
Integral gain Elevator

D.Gain_AIL C1: 80 %
Differential gain Aileron

D.Gain_ELE C1: 80 %
Differential gain Elevator

CYC_Rate 300d/5
Cyclic rate setting

EXPO_C1 -20 %
Exponential

Gv_Gain C1: 40 %
Governor gain

Condition Menu

CondMenu
When CondMenu is ON, this changes into CondMenu.

Governor Basic
Gover Basic Start

RPMSet: 11100rpm
Revolution setting

Gear_Rt 8.00
Gear ratio

Pole_Nmb 2
Pole number

ServoTyp Analog
Servo selection

Stick_SW IN: 80 %
Stick switch

On/OffSW Inhibit
Governor on/off switch

B/S_Sel Inhibit
Battery failsafe

LimitSet Idle
Servo limit point

LimitTest Idle
Limit point testing

Rev_Sens 1% 60 %
Revolution sensor testing

Response Middle
Response

Gv_Gain C1: 40 %
Governor gain

LLmt_Hov 25 %
Low limit hovering

LLmt_Idle 45 %
Low limit idle up

Governor Basic

S.BUS Basic
S.BUS Basic Start

S.BUSCN7 IIR: 4ch
Aileron channel

S.BUSCN8 IIR: 2ch
Elevator channel

S.BUSCN3 IIR: 2ch
Throttle channel

S.BUSCN1 IIR: 4ch
Rudder channel

S.BUSCN5 IIR: 5ch
Pitch channel

S.BUSCN9 IIR: 5ch
AIL gain channel

S.BUSCNA IIR: 10ch
ELE gain channel

S.BUSCN2 IIR: 5ch
RUD gain channel

S.BUSCN4 IIR: 7ch
RPM gain channel

S.BUSCN6 IIR: 5ch
Governor ON/OFF channel

S.BUSCNDnd
Condition channel

RESET S.Bus
S.BUS Reset

S.BUS Basic

MODE+ - : →
 DATA+ - : >

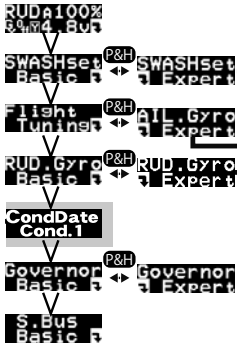

Governor Expert Start

Wrk.Mode
Governor working mode

Rv.Disp
Rotor
Revolution display mode

F/F.Cycl
0 %
Feed Forward from Cyclic

Yaw.Comp
CW/TPP
Yaw rate compensation

THR.Mode
Optimize
Throttle data mode

Rv.UpDly
8 Frm
Revolution change up delay

Rv.DnDly
10 Frm
Revolution down delay

StartDly
5 Frm
Start delay

On.Revo
60 %
Governor ON revolution

BFS.Volt
3.3V
Battery F/S voltage setting

Low.Revo
1000rpm
Low revolution

RESET
Gov.
Governor data reset

Governor Expert

RUD.Gyro
Rudder Expert Start

RUD.Ntr
+0.0 us
Rudder servo neutral

GY.Gain
A: 100 %
Gyro basic gain

EXP.AVG
-20 %
Rudder exponential

Dly.Mode
Function
Rudder delay mode

CNT.Dlin
A: 15 n
Control delay in

CNT.Dout
A: 12 n
Control delay out

Stop.Dly
120 %
Stop delay

ANG.720c
AM +0c
Pirouette speed

CG.DlyInc
12 Frm
Gain change up delay

G.DlyDec
3 Frm
Gain change down delay

RUD.His
7.0 us
Rudder hysteresis

G.Track
+0 %
Gain tracking

F/F.Mix
Off
Feed Forward (F/F)mixing

F/F.Rate
Li: +0 %
F/F mixing rate

ACC.Gain
0
F/F mixing acceleration gain

Ntr.Obse
ON
Neutral compensation

Yaw.Smth
ON
Yaw smoother

RESET
RUD.Gyro
Rudder gyro data reset

Rudder Expert

AIL.Gyro
Aileron Expert Start

I.Gain AI
C1: 80 %
Integral gain

D.Gain AI
C1: 80 %
Differential gain

HeadResp
-1
Head Response

DeadBand
4.0
Dead band

AIL.Comp
Li: 0 %
Aileron compensation

FlipComp
Off
Flip compensation

RESET
AIL.Gyro
Aileron gyro data reset

Aileron Expert

ELE.Gyro
Elevator Expert Start

I.Gain EL
C1: 80 %
Integral gain

D.Gain EL
C1: 80 %
Differential gain

HeadResp
-1
Head Response

DeadBand
4.0
Dead band

RollComp
R: 0 %
Roll compensation

RESET
ELE.Gyro
Elevator gyro data reset

Elevator Expert

SWASHset
Swash Detail Start

PIT→AIL
A: 100 %
PIT→AIL mixing rate

PIT→ELE
A: 100 %
PIT→ELE mixing rate

PIT→ELE2
A: 100 %
PIT→ELE2 mixing rate

AIL→PIT
B: 100 %
AIL→PIT mixing rate

AIL→ELE
B: 100 %
AIL→ELE mixing rate

AIL→ELE2
B: 100 %
AIL→ELE2 mixing rate

ELE→PIT
B: 50 %
ELE→PIT mixing rate

ELE→AIL
B: 50 %
ELE→AIL mixing rate

ELE→ELE2
B: 100 %
ELE→ELE2 mixing rate

SWCP.AIL
B: 0 %
Linkage compensation AIL

CPA.Dir
Plus
Compensation direction AIL

SWCP.ELE
B: 0 %
Linkage compensation ELE

CPE.Dir
Plus
Compensation direction ELE

SpeedCmp
50 %
Speed compensation

SWASHRot
+0.0 deg
Swash rotation

ROT.Trak
+0.0 %
Rotational tracking

PhaseEqu
Off
Swash rotation

PIT.Comp
ON
Pitch compensation

RESET
SWASHset
Swash data reset

Swash Detail

() ← Only displayed in SWASH Type H4

F3C Style Tuning Section



EXCLUSIVE FUNCTION WHEN CHOOSING F3C STYLE

When choosing F3C style, the following function is added. Refer to the preceding clause about common feature with 3D.

**ROT.Equa
Off**

(Swash Basic) Rotational equalizer [default: off]

This parameter works to optimize pirouette stability during stationary and forward flight. Press the DATA [+] or [-] key to turn the function on or off.

**Equa.Dir
Normal**

(Swash Basic) Equalizer direction [default: normal]

This parameter sets the rotational equalizer direction. Setting method: When the CGY750 is in this mode, the swashplate will tilt on direction and stay that way. Observe the direction of the tilt relative to the surface on which the model sits. Rotate the model 90 degrees about its mainshaft clockwise or counterclockwise. The swashplate should remain tilted in the **same direction** relative to the surface on which the model sits. Adjust Equa.Dir from NORMAL to REVERSE if needed to keep the swashplate tilt in the same direction as the model is rotated. Correctly setting of the rotational equalizer is critical for proper flight performance during pirouettes. All linkages from servos to swashplate should be installed prior to setting direction.

**Wrk.Mode
CMT**

(Flight Tuning) Gyro working mode [default: CMT]

The available choices are CMT, Normal or AVCS. The CMT mode will allow you to select either AVCS or Normal mode via the transmitter. In Normal mode the gyro will always operate in Normal Rate Mode, and when AVCS it will always operate in AVCS Mode. Use the data [+] or [-] key to select the desired working mode.

**AIL.Sepa
6pnt**

(Flight Tuning) Aileron gain separation [default: 6pnt ranges: 0~20pnt]

This parameter sets the aileron and elevator of the gyro gain separation. 6pnt means the aileron gain is lesser 6 points with elevator gain. It is useful when the aileron and elevator gain channels are set to same channel and aileron and elevator gain are adjusted at the same time. The rationale for this parameters lies in the fact that most models functionally will tolerate more gyro gain on the elevator axis than on the aileron axis.

**RespSty
12 n**

(Flight Tuning) Response style [default: 12n ranges: 1~20n]

[RespSty] tunes the overall heading hold/AVCS effect of the system. Values of 8-12 n are compatible with moderate to aggressive flying styles and are good for most sport/3D flying. NOTE that with high(er) [RespSty] values, try to ensure that the swashplate is reasonably level prior to spool up.

**Stab.Gn
C1-5-**

(Flight Tuning) Stability gain setting [default: 5 ranges: 1~10]

Depending on many variables such as model, rotor blade design, head speed, head dampening, and servo choice, the amount of transmitter cyclic gyro gain that the model will tolerate without oscillation may be lower than the percentage that provides the most stable flight. If the model is observed to be oscillating or wobbling at your chosen headspeed with low transmitter cyclic gyro gain percentages, lowering the Stability.Gn parameter a point or two will allow for higher cyclic gyro gain without inducing a wobble or oscillation in the model.

**HP.Gain
60 %**

(Flight Tuning) High pitch gain [default: 60% ranges: 0~100%]

HP.gain (high pitch) sets the cyclic gyro's internal control algorithm gain with high or low collective pitch inputs. Increasing this parameter's percentage results more holding power as collective pitch is input aggressively during aerobatics, but if its value is tuned too high, wobble or oscillation may occur.

**FLT.Mode
3D**

(Rudder Basic) Flight mode [default: 3D]

Selects the flight mode. Always try the "Sports" flight mode first and if you determine that the feel is not aggressive enough or if the pirouette rate is not fast enough then try the "3D" flight mode. The "Sports" Flight Mode will satisfy most pilots. The flight mode is changed by pushing the data [+] or [-] key.

**B/FS.Set
Inhibit**

(Governor Basic) Battery failsafe setting [default: Inhibit]

The governor goes into the failsafe mode when the battery voltage is below BFS.Volt. When activated, the governor is deactivated, and the throttle servo is moved to B/FS position. When the throttle stick is moved to idle position, the B/FS condition is deactivated for 30 seconds and then returned to B/FS after 30 seconds have passed. Move the throttle stick to B/FS position as desired. Push set key to confirm the setting. Pushing RSET will inhibit the function.

**LimitTst
-Idle-**

(Governor Basic) Limit point testing

Limit point setting confirms the throttle servo position at idle and full throttle. Push data + or - key. Throttle servo moves to the setting point indicated on the display.

**Response
Middle**

(Governor Basic) Response [default: Middle]

This parameter selects the governor operation response. Select the best match for your engine type. Pushing data+ or - key, the mode is changed. Recommended selection are, Middle → glow engine, Moderate → gasoline engine, Quick → brushless motor, Silent → electric models when RPM detection is accomplished either with a magnet on the motor's rotor or with a brushless phase sensor.

**S.BusCn9
AGn: 9ch**

(S.BUS Basic) S.BUS setting: AIL gain channel [default: 9ch]

Using the data [+] or [-] keys to set the correct channel number.

**S.BusCnA
EGn: 10ch**

(S.BUS Basic) S.BUS setting: ELE gain channel [default: 10ch]

Using the data [+] or [-] keys to set the correct channel number.

**THR.Mode
Optimize**

(Governor Expert) Throttle data mode [default: Optimize]

This parameter selects the throttle input operation. Pushing data+ or - key, the mode is changed.

Optimize:

CGY750 sets the throttle input signal to optimum. There is no need to consider the throttle curve setting on the transmitter.

Fixed:

The fixed throttle input is utilized related to the revolution. It is recommended for electric motors.

Tx.Curve:

CGY750 uses the exact throttle input from the transmitter. The throttle curve setting on the transmitter is required. When the Rev.Lmt mode is selected, this mode should be selected.

**On.Revo
60 %**

(Governor Expert) Governor ON revolution setting [default: 60%] [ranges: 50% ~ 90%]

This parameter tells the governor at what percentage of the set rpm it is to become active. The default value is 60 %. In this case, the governor will not engage until the engine rpm reaches 60 % of the set rpm. If you feel that the time for governor engagement is too slow, decrease the value to 50 ~ 55%. The starting time will be faster.

**BFS.Volt
3.8 v**

(Governor Expert) Battery F/S voltage setting [default: 3.8V] [ranges: 3.5V ~ 7.5V]

This parameter sets the battery fail safe and low battery alarm voltage. Set the proper voltage by the battery type. The battery characteristics are different depending on cell type/chemistry. The voltage setting is changed by pushing DATA+ or - key. Suggested setting voltages are as follows.

- 4 cells NiCd or NiMH (Normal: 4.8v) = 3.8 v
- 2 cells LiFe (Normal: 6.6 v) = 6.0 ~ 6.2 v
- 2 cells LiPo (Normal: 7.4 v) = 7.2 ~ 7.4 v

**GY.Gain
A: 100 %**

(Rudder Expert) Gyro basic gain [default: 100%] [ranges: 50% ~ 120%]

This parameter sets the base gain of the gyro. This can be used to adjust the gain % if your actual transmitter gain does not match the gain on the CGY750 correctly.

Dly.Mode Function	(Rudder Expert) Rudder delay mode [default: Function] Select [Function] for a softer control feel and [Constant] for a linear and aggressive feel.
Stop.Dly 120 %	(Rudder Expert) Stop delay [default: 120%] [ranges: 100% ~ 400%] This parameter may also be used to adjust the aggressiveness of the stop but is individually NOT tuneable for LEFT versus RIGHT tail rotor commands. Larger values will soften the tail stops resulting in less bounce. Use the data [+] or [-] key to adjust the value.
CG.DlInc 12 Fr	(Rudder Expert) Gain change up delay [default: 12] [ranges: 1 ~ 50] This parameter sets the delay of change of the gyro gain from low to high when switching from idle up to hover and helps avoid the chance for tail rotor hunting during this switch. Use the data [+] or [-] key to adjust the value.
G.DlyDec 3 Fr	(Rudder Expert) Gain change down delay [default: 3] [ranges: 1 ~ 50] This sets the delay of the gyro gain from high to low as would occur during a switch from hover into idle up and helps prevent the tail from feeling "loose" while the head speed accelerates to the higher rate. Use the data [+] or [-] key to adjust the value.
RUD.His 7.0 uS	(Rudder Expert) Rudder hysteresis [default: 7 uS] [ranges: 0 uS ~ 50 uS] Hysteresis adjusts the range right around center of tail rotor stick travel within which a tail rotor input will result in no rudder servo movement. The greater the value, the wider the range where stick movement yields no servo movement. Use the data [+] or [-] key to adjust the value.
G.Track +0 %	(Rudder Expert) Gain tracking [default: 0%] [ranges: -20% ~ +20%] Gain tracking is another method to adjust how the tail rotor stops. For example, when there is a bounce when stopping a left pirouette or the helicopter coasts when stopping right pirouette, increase gain tracking in the + direction. In the opposite situation, shift the gain tracking in the - direction.
F/F.Mix Off	(Rudder Expert) F/F mixing [default:off] Feed Forward mixing is activated with this parameter. F/F mixing is a pitch to rudder mix applied outside of the gyro compensation's control loop and before the gyro itself can even sense undesired tail rotor movement. F/F mixing is handled within the CGY750. Do not attempt to use revolution or acceleration mixing within your transmitter as this will actually adjust the input signal to the gyro and cause drifting.
Ntr.Obse ON	(Rudder Expert) Neutral compensation [default: on] This parameter works to recall the neutral point of the rudder servo for improving tail stop motion. To use this parameter effectively, hover the helicopter for about one second, and memorize the neutral point. If flying a 3D helicopter, this parameter may not work as well due to the quick and aggressive movements, so test with it turned on and off and decide which yields better stop behavior. Use the data [+] or [-] key to enable or disable this option.
Yaw.Smth ON	(Rudder Expert) Yaw smoother [default: on] This parameter selects the rudder control feeling. When turned on, rudder control becomes more exact. When turned off, rudder control authority increases. Select the rudder control feeling to your taste. Use the data [+] or [-] key to enable or disable this parameter.

I.GainAI ci 80 %	(AIL,ELE Expert) I gain <integral gain> [default: AIL 80% ELE 80%] [ranges: 0% ~ 200%] I gain tunes the ability of the model to maintain a given heading. Inadequate I gain results in a change in model heading especially with aggressive collective pitch input. Excessive I gain can result in oscillations in forward flight or with cyclic input. On the ELE axis especially, excessive I gain can create bounce.
I.GainEL ci 80 %	
D.GainAI ci 80 %	(AIL,ELE Expert) D gain <derivative gain> [default: AIL 0% ELE 80%] [ranges: 0% ~ 250%] D gain is best used to tune the stops following cyclic commands. Inadequate D gain results in a large slow bounce. Excessive D gain causes cyclic coasting with a quick bounce or oscillation in forward flight or with cyclic input.
D.GainEL ci 80 %	
AIL.Comp L: 0 %	(AIL Expert) Aileron compensation [default: 0%] [ranges: 0%~ 100%] This parameter sets the mixing rate of the pitch to aileron mixing. The roll axis may be affected by positive/negative collective pitch movement as manifested by the model rolling off either to the left or to the right during rapid ascent or descent. This mixing compensates this effect. The mixing amount can be adjusted individually for both positive and negative collective pitch inputs.
FlipComp U: 0 %	(ELE Expert) Flip compensation [default: 0%] [ranges: 0%~ 100%] This parameter sets the mixing rate of the elevator to aileron mixing. The roll axis may be affected by a pitch axis (elevator) input as manifested by the model rolling off to the left or right during flips or loops. This mixing compensates this effect. The mixing amount can be adjusted individually for both up and down elevator stick inputs.
RollComp R: 0 %	(AIL Expert) Roll compensation [default: 0%] [ranges: 0%~ 100%] This parameter sets the mixing rate of the aileron to elevator mixing. The elevator axis may be affected by the aileron input as manifested by a tendency for the model to corkscrew or otherwise roll non-axially. This mixing compensates this effect. The mixing amount can be adjusted individually for both left and right aileron inputs.
ROT.Trak +0.0 %	(Swash Detail) Rotational tracking [default: 0%] This parameter tunes the rotational equalizer to the pirouette characteristics of the model. When pirouetting the model at the desired rate, observe the model's rotor DISK (NOT the mechanics) and tune the ROT.Trak until the disk stays flat during the pirouette. Find the best average setting for both left and right pirouettes
PhaseEqu Off	(Swash Detail) Phase equalizer [default: off] This parameter optimizes swashplate phasing during pirouettes. Press the DATA [+] or [-] key to turn the function on or off. NOTE: This parameter needs rotor head RPM and direction of rotation to work correctly, so please set the rotor head RPM and direction in the governor menu. NOTE that rotor head speed information must still be set into the CGY750 governor menu even if using an electronic speed control (ESC) with an electric model.
PIT.Comp ON	(Swash Detail) Pitch Compensation [default: ON] This parameter works to hold the nose and the angle that the helicopter is set at regardless of collective pitch movements and direction changes. Press the DATA [+] or [-] key to turn the function on or off.

©Copyright 2013. No part of this manual may be reproduced in any form without prior permission. The contents of this manual are subject to change without prior notice. While this manual has been carefully written, there may be inadvertent errors or omissions. Please contact our service center if you feel that any corrections or clarifications should be made.

FUTABA CORPORATION Phone: +81 475 32 6982, Facsimile: +81 475 32 6983
1080 Yabutsuka, Chosei-mura, Chosei-gun, Chiba 299-4395, Japan

©FUTABA CORPORATION 2016, 1 (1)